

# User manual

## 16800 - 115 / 230 V

Electronically controlled motor,  
constant torque  
with intermediate reverse



 swiss made

  
**BERGEON**  
Depuis 1791

## TABLE OF CONTENTS

<b>Chap.</b>	<b>Description</b>	<b>Page</b>
<b>1</b>	<b>GENERALITY</b>	<b>1</b>
<b>2</b>	<b>Recommendations and precautions before use</b>	<b>1</b>
<b>3</b>	<b>Components descriptions</b>	<b>2</b>
<b>4</b>	<b>INSTALLATION</b>	<b>2-3</b>
4.1	 Connection in 115 or 230V	2
4.2	Adjusting the belt tension	2
4.3	Manual control box connection	2
4.4	Pedal control box connection (optional)	3
4.5	Positioning the motor on the base	3
4.6	Power on	3
<b>5</b>	<b>Use</b>	<b>3</b>
5.1	ON/OFF function	3
5.2	Reverse rotation function	3
5.3	Speed increase function	3
5.4	Speed reduce function	3
5.5	Reset after an emergency stop	3
<b>6</b>	<b>Maintenance</b>	<b>3</b>
6.1	Change the fuse	3
<b>7</b>	<b>Explanatory diagrams</b>	<b>4-7</b>
7.1	Diagram N° 1	4
7.2	Diagram N° 2	4
7.3	Diagram N° 3	5
7.4	Diagram N° 4	5
7.5	Diagram N° 5	6
7.6	Diagram N° 6	6
7.7	Diagram N° 7	7
7.8	Diagram N° 8	7
<b>8</b>	<b>Conformity certification</b>	<b>8</b>

## 1 GENERALITY

This user manual is part of the supplies and must always be at the disposal of the operators. It is to be kept carefully and in case of resale to be given to the future owner of the device.

Regarding the operating instructions described in this manual, we reserve the right to make technical modifications to the equipment as a result of technological innovations.

A user manual can not take into account all forms of use. For further information or problems that are not covered in detail in these operating instructions, please contact your distributor or the manufacturer.

## 2 RECOMMENDATIONS AND PERCAUTIONS BEFORE USE

### Take the time to read all the instructions.

- This device complies with applicable standards and regulations (Low Voltage Guidelines, Electromagnetic Compatibility, environment...). Considering the diversity of standards in force, if this device is used in a country other than where it was purchased, please have it checked by an Authorized Service Center.
- This device is not intended for use by persons with reduced physical, sensory or mental capacities or by persons with no experience or knowledge unless they are under supervision and prior instructions concerning the use of the device through a person being responsible for their safety.
- Do not move the device while it is in use.
- Place your device on a stable, clean work surface.
- Check that the connection of the device corresponds to the mains voltage (alternating current only),  
 Chapter **4.1**.
- Do not use the device if:
  - The device has a defective or damaged cable,
  - The device has fallen and has visible deterioration.

In each case, the device must be sent to the distributors or manufacturer in order to avoid danger.

- Make sure that your electrical installation has sufficient power for this device.
- Do not unplug the device by pulling on the cord.  
Use only an extension cable in good condition and with a conductor wire with a cross section at least equal to the wire supplied with the product.
- Unplug the device from the power supply during long time of no using or before cleaning.
- To avoid electric shock, always avoid contact with water or other liquids.
- Handle the device with care: any sudden shock or excessive handling may cause deterioration.
- If a part of the device becomes inflamed, never attempt to extinguish it with water. Unplug the device and smother the flames with a damp cloth.
- Do not use cleaning agents containing solvents or alcohol.
- For your safety, never disassemble the unit by yourself; please inform the distributors or manufacturer.
- This device is developed mainly for professional use.

Any other inappropriate use does not engage the manufacturer's liability or guarantee.

### 3 COMPONENTS DESCRIPTIONS

N°	Designation	Notification	Page
1	Motor housing		4, 7
2	Main switch ON/OFF		4
3	Fuse		4
4	Connector: control - footswitch		4
5	Connector: control - manual		4, 5
6	Connector: power supply		4
7	Trapezoidal primary belt		4, 6
8	Belt tension pulley		4
9	Primary pulley knob		4
10	Pedal control box		6
11	Manual control box		4, 5
12	Emergency Stop Switch		4, 5
13	Switch + C1 of the control	Increase number of turns	4, 5
14	Switch - C2 of the control	Decrease number of turns	4, 5
15	Switch + P1 pedal	Increase number of turns	6
16	Switch + P2 pedal	Decrease number of turns	6
17	Cable 115V / 230V		5
19	Vibration gap of the belt		6
20	Protection cover's fixing screw		4
21	Protection cover		4
22	Display of the rotation speed		4
23	Base		7
24	Round Secondary Belt		7
25	Pulley of the lathe		7
26	Motor housing secondary pulley		7

See Diagrams from 1 to 8.

### 4 INSTALLATION

 **IMPORTANT:** These operations must be performed **when the control is not powered.**

#### 4.1 Connection in 115 or 230V

Each device is delivered with:

-  a cable for **115V** and **230V**.

- 1) Make sure the main switch **(2)** is on the **OFF position**.
- 2) Connect the cable **(17)** to the plug **(6)** on the back of the device.

#### 4.2 Adjusting the belt tension

 **IMPORTANT:** As it is a trapezoidal belt, the motor belt must **not be tightened excessively.**

- 1) Tighten the trapezoidal primary belt **(7)** by means the belt tension knob **(8)** so that the vibration gap is about 10 millimeters from the belt **(19)**.

#### 4.3 Manual control box connection

- 1) Check that the emergency stop button **(12)** is triggered (in the high position).
- 2) Connect the cable of the manual control box **(11)** to the connector **(5)** on the back of the housing.

#### 4.4 Pedal control box connection (optional)

- 1) Connect the footswitch cable **(10)** to the connector **(4)** on the back of the housing.

#### 4.5 Positioning the motor on the base

 **IMPORTANT:** It is not intended to fix the motor housing **(1)** to the base **(23)** because its weight is sufficient to allow accurate tension of the belt.

- 1) Position the motor housing in such a way that the secondary pulley of the motor housing is aligned with the central pulley of the lathe **(25)**.
- 2) Position the round belt on the 2 pulleys **(25)** and **(26)**.
- 3) Tighten the belt **(24)** by moving the motor housing **(1)**.



#### 4.6 Power on

- 1) Make sure the main switch **(2)** is on the **OFF position**.
- 2) Insert the cable plug **(17)** or **(18)** into the mains.
- 3) Switch the control switch **(2)** to ON.

### 5 USE

#### 5.1 ON/OFF function

- 1) Simultaneously press the two buttons **(13)** C1 and **(14)** C2 of the controller or **(15)** P1 and **(16)** P2 of the pedal for about 1 second.

 **IMPORTANT:** After a stop, the motor **always** restarts in the same direction of rotation (counterclockwise). 

 **REMARK:** All of the operations discussed below may be carried out when the engine is in operation without risk of damaging it.

#### 5.2 Reverse rotation function

- 1) Simultaneously and shortly press (0.5 seconds) on the two switches **(13)** C1 and **(14)** C2 of the control or on **(15)** P1 and **(16)** P2 of the pedal.

#### 5.3 Speed increase function

- 1) Press the switch **(13)** C1 or the pedal **(15)** P1 to reach the desired speed. The number of turns is shown on the display **(22)**.

#### 5.4 Speed reduce function

- 1) Press the switch **(14)** C2 or the pedal **(16)** P2 to reach the desired speed. The number of turns is shown on the display **(22)**.

#### 5.5 Reset after an emergency stop

- 1) Reboot by lifting up the Emergency Stop Button **(12)**.
- 2) Turn main switch OFF **(2)**.
- 3) **Wait** until the number « **1** » appears on the Display **(22)**.
- 4) Switch the main switch ON **(2)**.

### 6 MAINTENANCE

#### 6.1 Change the fuse

- 1) Open the fuse compartment **(3)** with a screwdriver.
- 2) Change the fuse type 4T A. Change the fuse, type 4T A.
- 3) Close the fuse compartment **(3)** with a screwdriver.

## 7 EXPLANATORY DIAGRAMS

### 7.1 Diagram N° 1



### 7.2 Diagram N° 2



### 7.3 Diagram N° 3



### 7.4 Diagram N° 4

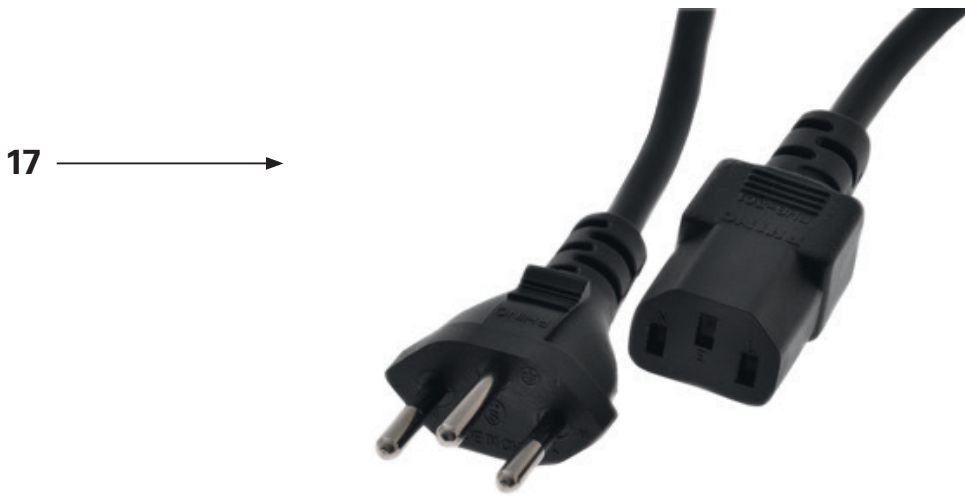

### 7.5 Diagram N° 5



### 7.6 Diagram N° 6

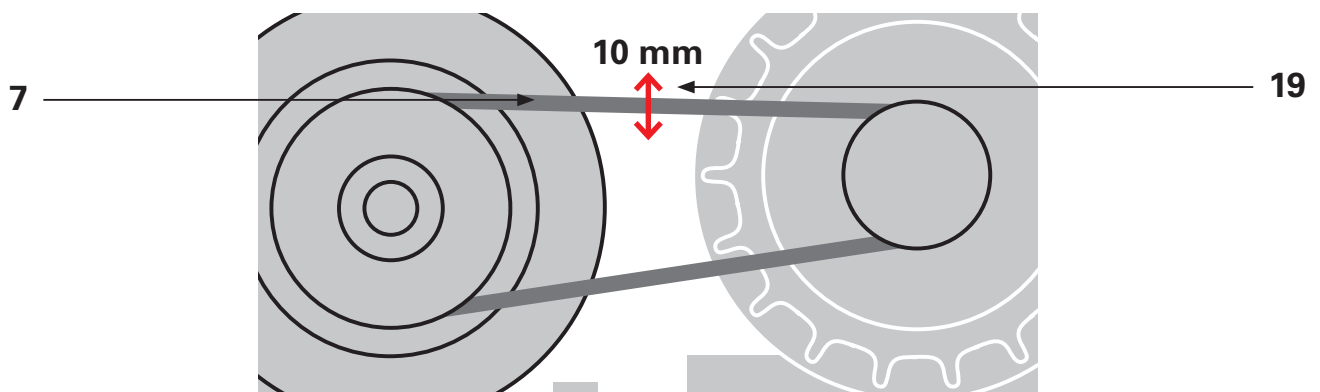



### 7.7 Diagram N° 7

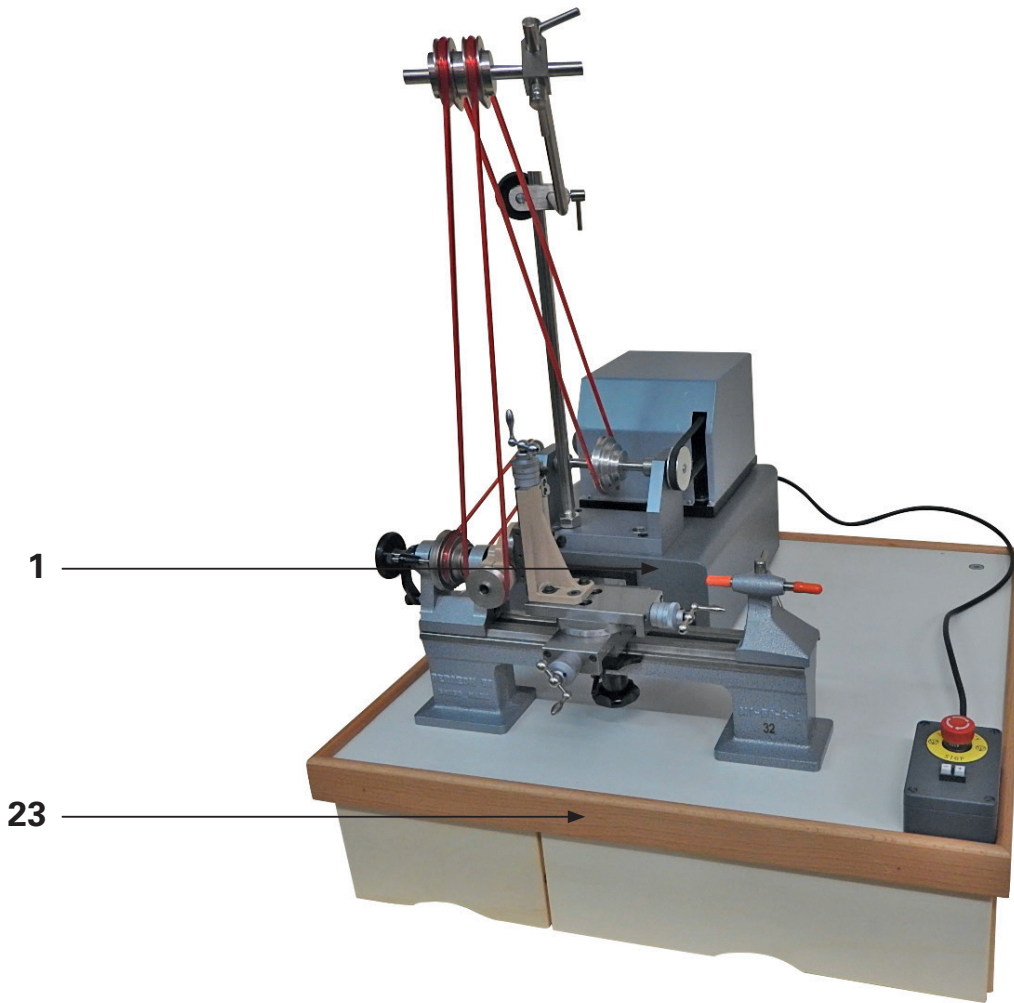

### 7.8 Diagram N° 8

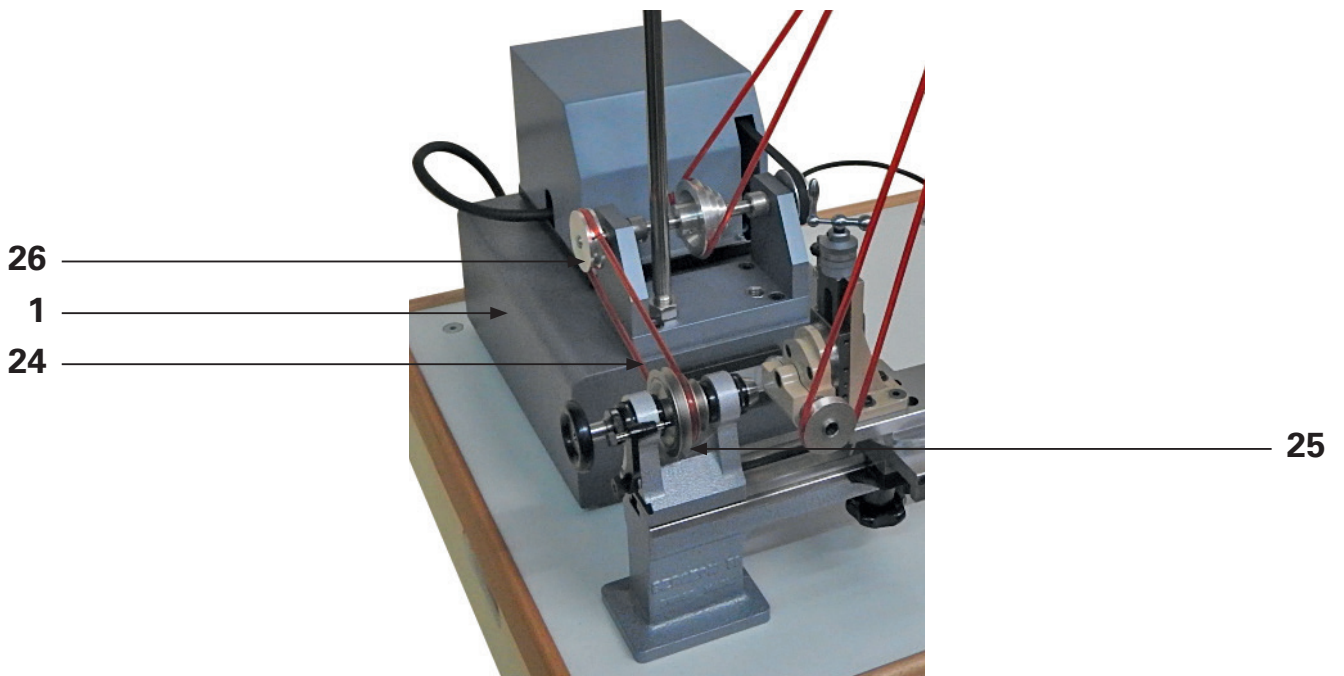

## 8 CONFORMITY CERTIFICATION

<b>Déclaration CE de conformité</b>		<b>FR</b>
<p>Nous, Bergeon SA, déclarons par la présente que le produit "MOTEUR POUR L'HORLOGER RHABILLEUR" type 16800 - 115 / 230 V numéro de série satisfait toutes les exigences essentielles des directives suivantes :</p> <p style="text-align: right;">2006/42/CE - Directive CE pour machines 2014/35/UE - Directive CE pour basse tension 2014/30/UE - Directive CE de compatibilité électromagnétique</p> <p>Normes harmonisées utilisées :</p> <p>Autres normes et spécifications techniques utilisées : 2011/65/UE ROHS / 2012/19/EU DEEE/WEEE</p>		
<b>EG-Konformitätserklärung</b>		<b>DE</b>
<p>Wir, Bergeon SA, erklären hiermit, dass das Produkt "MOTEUR POUR L'HORLOGER RHABILLEUR" Typ 16800 - 115 / 230 V Seriennummer allen grundlegenden Anforderungen der nebenstehenden Richtlinien entspricht :</p> <p style="text-align: right;">2006/42/CE - EG-Maschinenrichtlinie 2014/35/UE - EG-Niederspannungrichtlinie 2014/30/UE - EG-Richtlinie über elektromagnetische Verträglichkeit</p> <p>Angewendete harmonisierte Normen :</p> <p>Angewendete sonstige technische Normen und Spezifikationen : 2011/65/UE ROHS / 2012/19/EU DEEE/WEEE</p>		
<b>EC Declaration of Conformity</b>		<b>EN</b>
<p>We, Bergeon SA, hereby declare that the product "MOTEUR POUR L'HORLOGER RHABILLEUR" type 16800 - 115 / 230 V serial number satisfies all the essential requirements of the following Directives :</p> <p style="text-align: right;">2006/42/CE - EC machinery directive 2014/35/UE - EC low voltage directive 2014/30/UE - EC electromagnetic compatibility directive</p> <p>Harmonised standards applied :</p> <p>Other technical standards and specifications applied : 2011/65/UE ROHS / 2012/19/EU DEEE/WEEE</p>		
<b>Dichiarazione CE di conformità</b>		<b>IT</b>
<p>La ditta, Bergeon SA, dichiara che il prodotto "MOTEUR POUR L'HORLOGER RHABILLEUR" tipo 16800 - 115 / 230 V numero di serie è conforme a tutti i requisiti essenziali previsti dalle direttive riportate a lato :</p> <p style="text-align: right;">2006/42/CE - Direttiva CE per macchine 2014/35/UE - Direttiva CE per tensione bassa 2014/30/UE - Direttiva CE di compatibilità elettromagnetica</p> <p>Norme armonizzate applicate :</p> <p>Altre norme e specificazioni tecniche applicate : 2011/65/UE ROHS / 2012/19/EU DEEE/WEEE</p>		
<b>Declaración de conformidad CE</b>		<b>ES</b>
<p>Nosotros, Bergeon SA, declaramos por la presente que el producto "MOTEUR POUR L'HORLOGER RHABILLEUR" Tipo 16800 - 115 / 230 V número de serie satisface todas las exigencias esenciales de las directivas siguientes :</p> <p style="text-align: right;">2006/42/CE - Directiva CE para máquinas 2014/35/UE - Directiva CE para baja tensión 2014/30/UE - Directiva CE de compatibilidad electromagnética</p> <p>Normas armonizadas aplicadas</p> <p>Otras normas y especificaciones técnicas utilizadas : 2011/65/UE ROHS / 2012/19/EU DEEE/WEEE</p>		
<p><small>Personne autorisée à constituer le dossier technique conformément à l'annexe VII A de la directive 2006/42/CE Bevollmächtigte Person für das Zusammenstellen der technischen Unterlagen gemäss Anhang VII A der Richtlinie 2006/42/EG Person authorised to compile the technical file in accordance with Annex VII A of Directive 2006/42/CE Persona autorizzata a compilare la documentazione tecnica secondo l'allegato VII A della Direttiva 2006/42/CE Persona autorizada a constituir el expediente técnico de acuerdo con el anexo VII A de la Directiva 2006/42/CE</small></p> <p>V.Zennaro Bergeon SA 11, Avenue du Technicum 2400 Le Locle Suisse</p>		

**Bergeon SA**  
**11, Avenue du Technicum**  
**2400 Le Locle**

**2400 Le Locle, 10.05.2017**

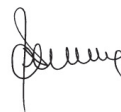

**V.Zennaro**  
**Directeur**



**S.Lanza**  
**Resp. Qualité**





Retrouvez tous nos produits en ligne  
 Finden Sie alle unsere Produkte online  
 Find all our products online  
 Encuentre todos nuestros productos online

[www.bergeon.ch](http://www.bergeon.ch)





 Bergeon SA

Outillages et équipements pour l'horlogerie, la bijouterie et la microtechnique

**BERGEON SA**  
 11, av. du Technicum  
 CH - 2400 Le Locle

Tél. + 41 32 933 60 00  
 Fax + 41 32 933 60 01

[www.bergeon.ch](http://www.bergeon.ch)  
[info@bergeon.ch](mailto:info@bergeon.ch)