



News



BASELWORLD

March 23 to 30, 2017

Hall | Booth
2.0 | H44



BERGEON
Depuis 1791

7865



1450 x 650 x 930-1230 mm

Etabli d'horloger

Etabli d'horloger avec hauteur réglable manuellement. Plateau en bois reconstitué plaqué hêtre. 2 layettes de 5 tiroirs et tiroir central. Accoudoirs en similicuir noir, avec angles d'inclinaison réglables.

Uhrmacherwerktisch

Uhrmacherwerktisch, Höhenverstellung mit Kurbelsystem. Arbeitsplateau aus Buche. 2 Schubladensäule und zentrale Schubladen. Armlehnen aus schwarzem Kunstleder, verstellbar.

Watchmaker bench

Watchmaker bench, height adjustable by crank system. Robust bench top in beech. 2 cabinets with 5 drawers and a central drawer. Armrest in imitation leather and adjustable angles.

Mesa de relojero

Mesa de relojero con ajuste de altura manualmente. Tablero en haya reconstituida. 2 muebles con 5 cajones y cajón central. Apoyabrazos de piel sintética negra, regulables.

B I F L E X

SWISS MADE



7943

Air/vacuum pour établi

Système Biflex complet à contre-poids avec dispositif de blocage comprenant une soufflette et un crayon vacuum (une soufflette et deux crayons vacuum pour le TriFlex, réf. 7943-TRI).

Les tubes sont orientables, flexibles et séparables pour une meilleure ergonomie.

Luft/Vakuum für Arbeitstisch

Komplettes Biflex System mit Gegengewichte und Blockiervorrichtung. Integrierter Präzisionsbläser und Vakuum-Stift (ein Präzisionsbläser und zwei Vakuum-Stifte bei dem TriFlex Ref. 7943-TRI).

Für eine bessere Ergonomie sind die Rohre einstellbar, flexibel und trennbar.

Air/Vacuum for Bench

Complete Biflex system with counterweights and locking device. Including a precision blower and a vacuum stylus (one precision blower and two vacuum styluses for the TriFlex ref. 7943-TRI).

To enhance ergonomics, the pipes are adjustable, flexible and separable.

Aire/vacío para mesa de relojero

Sistema Biflex completo de contrapesos y dispositivo de bloqueo. Completo de tobera de aire y escobilla de vacío (1 tobera de aire y 2 escobillas de vacío para Triflex, Ref. 7943-TRI)

Los tubos son ajustables, flexibles y separables para garantizar una mejor ergonomía.

8809-R45

swiss made



8809-RD



Crayon vacuum

Débit réglable par poussoir, s'utilise avec une pompe vacuum ou sur le réseau.

Vakuum-Stift

Regulierbarer Ausstoß durch Drücker, benutzt sich mit eine Vakuumpumpe oder auf dem Netz.

Vacuum stylus

Flow adjustable by pusher, to be used with a vacuum pump or on the network.

Lápiz de vacío

Producción ajustable por botón, se utiliza con una bomba vacuum o en la red.

8809-B-2

8809-B-1

*Très douce
 Sehr weich
 Very soft
 Muy suave*



*Douce
 Weich
 Soft
 Suave*

8809-B-3



*Rude
 Hart
 Coarse
 Grueso*

Brosses pour crayon vacuum

Poils en matière synthétique.

Bürsten für Vakuum-Stift

Borsten aus Kunststoff.

Brushes for vacuum stylus

Synthetic bristles.

Cepillos par lápiz de vacío

Pelos en materia sintética.

7809-R45

swiss made



Soufflette de précision

Débit réglable par poussoir, s'utilise avec un compresseur ou sur le réseau.

7809-RD

Genauigkeitsblasebalg

Regulierbarer Ausstoß durch Drücker, benutzt sich mit einem Kompressor oder auf dem Netz.

Precise bellows

Flow adjustable by pusher, to be used with a compressor or on the network.

Fuelle de precisión

Producción ajustable por botón, se utiliza con un compresor o en la red.

R-COMBI

SWISS MADE

6100-230

*Pression
 Druck
 Pressure
 Presión*



*Vacuum
 Vakuum
 Vacuum
 Vacío*



700 x 440 x 590 mm

Compresseur Combi-vacuum avec sécheur d'air

Vacuum: -0.8 bars. Pressure: 8 bars. Niveau sonore: 40 dB. Débit: 50 L / min. Réservoir tampon: 2x14 L.

Kombi-Vakuum-Kompressor mit Lufttrockner

Vakuum: -0,8 bar. Druck: 8 bar. Geräuschpegel: 40 dB. Leistung: 50 L / min. Tank: 2x14 L.

Combi-vacuum compressor with air dryer

Vacuum: -0.8 bars. Pressure: 8 bars. Sound level: 40 dB. Flow: 50 L / min. Tank: 2x14 L.

Compresor Combi-vacío con secador de aire

Vacío: -0,8 bar. Presión: 8 bar. Nivel de ruido: 40 dB. Flujo: 50 L / min. Tanque: 2x14 L.

7965-S12

swiss made

Ø 0.60 / 0.70 / 0.80 / 0.90 / 1.00 / 1.20 / 1.40 / 1.50 / 1.60 / 1.80 / 2.00 / 2.50



Socle tournant de 12 tournevis d'horloger avec profilé spécial

Muni de 6 emplacements permettant de disposer des cartouches dynamométriques 7965-C et d'un container amovible avec mèches de rechanges.

Drehender Sockel mit 12 Uhrmacher-Schraubendrehern mit speziellem Profil

Mit 6 Platzierungen für dynamometrische Trommeln 7965-C und einen abnehmbaren Behälter für Ersatzklingen.

Turning stand with 12 watchmaker screwdrivers with special profile

With 6 emplacements to fit dynamometric cylinders 7965-C and a removable container for spare blades.

Surtido de 12 destornilladores de relojero con perfil especial

Con 6 emplazamientos para los cartuchos dinamométricos 7965-C y un contenedor extraíble con mechas de recambio.



7965-C...

swiss made

**TORK
SPEED**
SWISS MADE
PATENT PENDING

10 - 15 - 20 - 25 - 30 - 35 - 40 - 45 - 50 - 55 - 60 mNm



Cartouche dynamométrique amovible

Acier inox. S'adapte sur tous les tournevis dédiés référence 7965-...
Couple préréglé et fixe: 10 à 60 mNm.
Bidirectionnelle. Positionnable sur toute la longueur du tournevis.
Possibilité de monter 2 cartouches sur le tournevis.

Abnehmbare dynamometrische Trommel

Aus Edelstahl. Passt auf alle Schraubendreher mit der Referenz 7965-...
Eingestelltes, festes Drehmoment: 10 bis 60 mNm.
Bidirektionale Trommel. Kann auf der ganze Länge des Schraubendrehers positioniert werden.
Möglichkeit den Schraubendreher mit 2 Trommeln auszustatten.

Demountable dynamometric cylinder

Stainless steel. Fit on all specific screwdrivers with reference 7965-...
Pre-set, fixed torque: 10 to 60 mNm.
Bidirectional cylinder. Can be easily positioned on the whole length of the handle of the screwdriver.
Possibility to equip the screwdriver with 2 cylinders.

Cartucho dinamométrico amovible

Acero inoxidable. Se adapta en todos los destornilladores dedicados referencia 7965-...
Cople preajustado y fijo: de 10 hasta 60 mNm.
Bidireccional. Posicionable en todo el largo del destornillador.
Posibilidad de montar 2 cartuchos en el destornillador.

7895-M-010-...  10x

7895-T-...

Tube plastique avec 2 mèches
2 Ersatzklingen in Plastiktuben
Plastic tube with 2 blades
Tubo plástico con 2 mechas



swiss made

Ø 0.50 - 0.60 - 0.70 - 0.80 - 0.90 - 1.00 - 1.10 - 1.20 - 1.30 - 1.40 - 1.50 - 1.60 - 2.00 - 2.20 - 2.50 - 3.00 mm

Mèches à flancs parallèles

En acier HSS 61 HRC.

Klingen mit parallelen Flanken

Aus Stahl HSS 61 HRC.

Blades with parallel-flanks

Steel HSS 61 HRC.

Mechas con flancos paralelos

Acero HSS 61 HRC.

30081-P05

Ø 0.80 / 1.00 / 1.20 / 1.40 / 1.60



swiss made

Pochette de 5 tournevis 30081

Tournevis ergonomique en acier inox avec tête en POM autolubrifiant et mèche conique en acier inox trempé 54/56HRC.

Tasche mit 5 Schraubenzieher 30081

Ergonomischer Schraubenzieher aus Edelstahl mit Kopf aus synthetischem selbstschmierenden POM Material und konischen Klingen aus gehärtetem Edelstahl 54/56HRC.

Pouch with 5 screwdrivers 30081

Ergonomic Screwdriver of stainless steel with head of synthetic self-lubricating POM material and conical blades of hardened stainless steel 54/56HRC.

Bolsa de 5 destornilladores 30081

Destornillador ergonómico en acero inoxidable con cabeza en POM autolubrificante y mecha cónica en acero inoxidable endurecido 54/56HRC.

6899-P05

Ø 0.80 / 1.00 / 1.20 / 1.40 / 1.60



swiss made

Pochette de 5 tournevis 6899

Tournevis ergonomique en acier inox garni d'un élastomère avec tête en POM autolubrifiant et mèche conique en acier inox trempé 54/56HRC.

Tasche mit 5 Schraubenzieher 6899

Ergonomischer Schraubenzieher aus Edelstahl und Elastomer Überzug mit Kopf aus synthetischem selbstschmierenden POM Material und Klingen aus gehärtetem Edelstahl 54/56HRC.

Pouch with 5 screwdrivers 6899

Ergonomic Screwdriver of stainless steel and elastomer coat with head of synthetic self-lubricating POM material and blades of hardened stainless steel 54/56HRC.

Bolsa de 5 destornilladores 6899

Destornillador ergonómico en acero inoxidable con guarnición elastómero con cabeza en POM autolubrificante y mecha cónica en acero inoxidable endurecido 54/56HRC.

5659

 **swiss made**

Ø 1.50 / 2.00 / 2.50 / 3.00

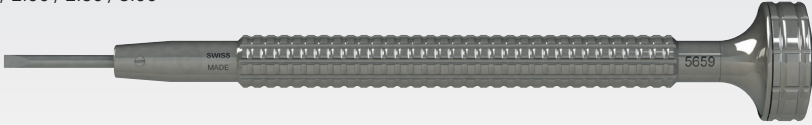

Tournevis à grande tête avec roulement à billes

Corps en acier inox avec profilé spécial. Mèche conique en acier inox trempé 54/56HRC référence 6899-M. Ø de la tête: 18 mm. Ø du corps: 8 mm. Longueur totale: 105 mm.

Schraubenzieher mit Kugellager

Schaft aus Edelstahl mit geriffeltem Profil. Konische Klinge aus gehärteten Edelstahl 54/56HRC Referenz 6899-M. Kopf Ø: 18 mm. Shaft Ø: 8 mm. Gesamtlänge: 105 mm.

Screwdriver with ball bearing head

Shank made of stainless steel with grooved profile. Conical blade made of hardened stainless steel 54/56HRC reference 6899-M. Ø of head: 18 mm. Ø of shank: 8 mm. Total length: 105 mm.

Destornillador cabeza con cojinetes de bolas

Mango de acero inoxidable con perfil especial. Mecha cónica de acero inoxidable endurecido 54/56HRC referencia 6899-M. Ø de la cabeza: 18 mm. Ø del mango: 8 mm. Largura total: 105 mm.

30081-TAM-...

 **swiss made**

Ø 1.00 / 1.20 / 1.30 / 1.40 / 1.60 / 1.80

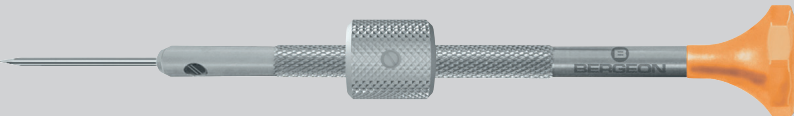

Tournevis avec tambour

Corps en acier inox moleté. Tête en matière synthétique POM autolubrifiant. Mèche conique en acier inox trempé 54/56HRC référence 6899-M. Force de serrage augmentée grâce au tambour.

Schraubenzieher mit Trommel

Schaft aus Edelstahl, gerändelt. Kopf aus synthetischem Material POM, selbstschmierend. Konische Klinge aus gehärteten Edelstahl 54/56HRC Referenz 6899-M. Der Trommel vergrößert der Anziehungskraft.

Sets of 2 drums

Shank in knurled stainless steel. Self-lubricating head, synthetic POM material. Conical blade made of hardened stainless steel 54/56HRC reference 6899-M. The drum allows increased screwing force.

Juegos de 2 tambores

Cuerpo en acero inoxidable. Cabeza de materia sintética POM autolubrificante. Mecha cónica de acero inoxidable endurecido 54/56HRC referencia 6899-M. Aumento del poder de ajuste a través del tambor.

30081-C-P05

Ø 1.20 / 1.50 / 2.00 / 2.50 / 3.00



swiss made

Pochette de 5 tournevis à mèches cruciformes

Tournevis ergonomique en acier inox avec tête en POM autolubrifiant et mèche cruciforme en acier inox trempé 54/56HRC.

Tasche mit 5 Schraubenzieher mit Kreuzschlitz Klingen

Ergonomischer Schraubenzieher aus Edelstahl mit Kopf aus synthetischem selbstschmierenden POM Material und Klingen aus gehärtetem Edelstahl 54/56HRC.

Pouch with 5 screwdrivers with Phillips blades

Ergonomic Screwdriver of stainless steel with head of synthetic self-lubricating POM material and blades of hardened stainless steel 54/56HRC.

Bolsa de 5 destornilladores con mechas Phillips

Destornillador ergonómico en acero inoxidable con cabeza en POM autolubrificante y mecha Phillips en acero inoxidable endurecido 54/56HRC.

30081-EX-7750

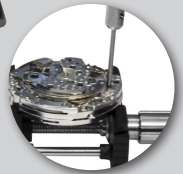
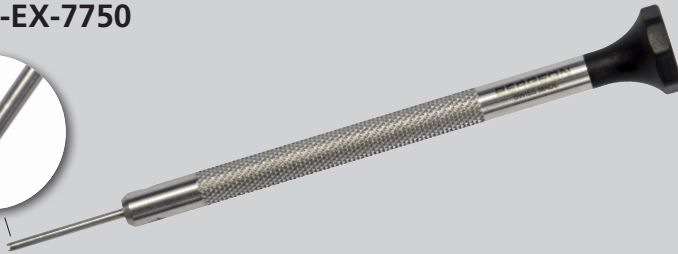

swiss made

Outil pour régler l'excentrique du calibre ETA Valjoux 7750

Tournevis avec mèche adaptée au réglage de l'excentrique du sautoir de compteur de minute pour la famille des calibres ETA Valjoux 7750.

Werkzeug um der Exzenter Schraube des Kaliber ETA Valjoux 7750 einzustellen

Schraubendreher mit angepassten Klinge zum einstellen der exzentrische Schraube der Minutenzähler für die Familie der Kalibern ETA Valjoux 7750.

Tool to adjust the eccentric screw of calibre ETA Valjoux 7750

Screwdriver with adapted blade to adjust the eccentric screw of the minute counter for the calibre range ETA Valjoux 7750.

Herramienta para ajustar el tornillo excéntrico de el calibre ETA Valjoux 7750

Destornillador con mecha adaptada para ajustar el tornillo excéntrico del contador de minutos para la familia de los calibres ETA Valjoux 7750.

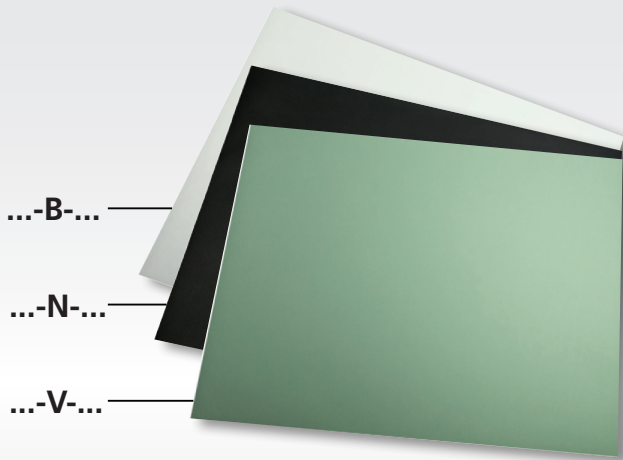

...-01

 1 x

...-10

 10 x

 swiss made

5808-... 320 x 240 x 1.5 mm

Sous-mains autocollant

Surface structurée, rigide et résistante à l'alcool isopropylique, partie inférieure autocollante.

Selbstklebend Arbeitsunterlage

Strukturierte, steife und Isopropylalkohol-resistente Oberfläche, selbstklebende Unterfläche.

Self-adhesive bench mat

Structured, stiff and isopropyl alcohol resistant surface, adhesive undersurface.

Carpeta de mesa auto-adhesivos

Superficie estructurada, rígido y resistente al alcohol isopropílico, parte inferior adhesiva.

6808-... 320 x 240 x 0.6 mm

Sous-mains autocollants fins

Surface lisse, rigide et résistante aux solvants, partie inférieure autocollante.

Selbstklebend zwecke Arbeitsunterlage

Glatte, steife und Lösungsmittel beständige Oberfläche, selbstklebende Unterfläche.

Fine self-adhesive bench mat

Flat, stiff and solvent resistant surface, adhesive undersurface.

Carpeta de mesa auto-adhesivos finos

Superficie lisa, rígida y resistente a disolventes, parte inferior adhesiva.

7808-... 320 x 240 x 2 mm

Sous-mains antidérapants

Surface légèrement structurée, souple et résistante à l'alcool isopropylique, partie inférieure antidérapante.

Rutschfeste Arbeitsunterlage

Leicht strukturierte, flexible und Isopropylalkohol-beständige Oberfläche, rutschfeste Unterfläche.

Anti-skid bench mat

Lightly structured, flexible and isopropyl alcohol resistant surface, anti-skid undersurface.

Carpeta de mesa antideslizante

Superficie ligeramente estructurada, flexible y resistente al alcohol isopropílico, parte inferior antideslizante.

Contenu - Inhalt - Content - Contenido

- 6745-G: 1x 040/060/080/1.00/1.50/2.00 mm
 6745-M: 2x 080/1.00/1.20 mm
 6745-MC: 1x 1.50/2.00 mm

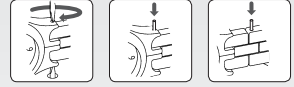

6745-SR28



8745-SRC



8745-BD

Broche avec cannelures spéciales permettant de monter les cartouches dynamométriques réf. 7965-C... Permet de maîtriser le serrage des vis de bracelets à un couple déterminé.

Brosche mit speziellen Rillen um dynamometrische Trommeln mit der Referenz 7965-C... zu montieren. Ermöglicht das kontrollierte Anziehen der Armbandschrauben mit einem bestimmten Drehmoment.

Runner with special flute to fit dynamometric cylinders with the reference 7965-C... Allows the controlled tightening of bracelet screws with a pre-defined torque.

Husillo acanalado con ranuras especiales para el montaje de los cartuchos ref. 7965-C... Permite apretar los tornillos de pulseras a una fuerza específica.

B-PRESS
 SWISS MADE

8745

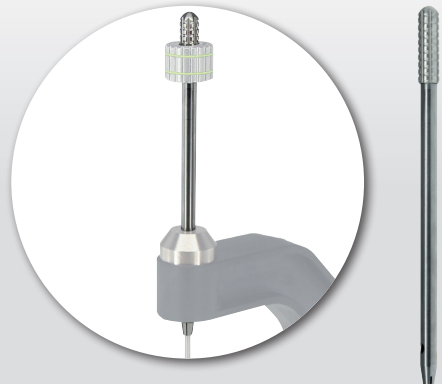

Potence multi-usage

En matériau composite.
 Pour chasser et déchasser les goupilles, visser et dévisser les vis des bracelets de montres.

Multifunktions-Pressstock

Im Verbundwerkstoff.
 Für das Ein- und Auspressen von Sperstiften, An- und Abschrauben von Uhrenarmbänder-Schrauben.

Multifunction Press

Made of composite material.
 To insert and remove pins as well as to screw and unscrew watch bracelets.

Prensa multi-usos

De material plástico compuesto.
 Para embutir y sacar las clavijas, para atornillar y destornillar las pulseras de relojes.

8745-BSC

7745-PG

B-PRESS
SWISS MADE



Contenu - Inhalt - Content - Contenido

6745-G: 1x 040/060/080/1.00/1.50/2.00 mm

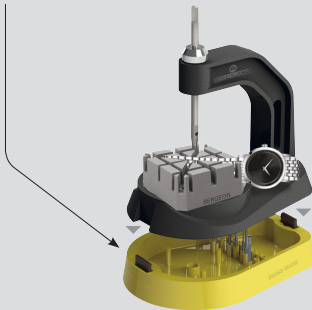

Potence

En matériau composite.
Pour chasser et déchasser les goupilles.

Presstock

Aus Verbundmaterial.
Zum Ein- und Ausstossen der Stifte.

Press

Made of composite material.
To insert and remove pins.

Prensa

De material composite.
Para embutir y sacar las clavijas.

B-SETTING4

SWISS MADE

8935



Potence à 4 broches pour poser les aiguilles

Tasseaux en matière synthétique interchangeables.
 Base: Ø 31 mm. Guidage précis des broches.
 Grande précision de positionnement.

Setting tool with 4 runners for hands

Interchangeable stakes made of synthetic material.
 Base: Ø 31 mm. Enhanced guidance of the spindles.
 High precision of positioning.

La broche "Limite Force" s'adaptant sur nos potences réf. 8935 permet à l'utilisateur de limiter la force de chasse exercée sur les aiguilles grâce à une sytème de débrayage. Cette force peut être réglée à l'aide d'un tournevis dans une plage de 5N à 40N avec une précision de ±15%

Die "Limite Force" Brosche, welche auf unsere Presstöcke 8935 passt, ermöglicht dem Benutzer die auf Zeiger ausgeübte Ausschlagskraft, durch ein Auskupplungssystem zu beschränken. Diese Kraft kann durch einen Schraubenzieher eingestellt werden, von 5N bis 40N mit einer Präzision von ±15%.

The "Limite Force" Runner, which fits with our 8935 setting tools, enables the user to limit the output force on hands through a gear system. This force can be regulated with a screwdriver, from 5N to 40N with a precision of ±15%.

El Husillo "Limitación de fuerza" se adapta a nuestra prensa ref 8935 permite al usuario de limitar la fuerza de caza aguja ejercida a través de un sistema de desacoplamiento. Esta fuerza se puede ajustar con un destornillador en una gama de 5 N a 40 N con una precisión de ± 15%.

8935-LF



Presstock mit 4 Spindeln zum Zeigersetzen

Austauschbare Tragsteine aus synthetischem Material. Basis: Ø 31 mm. Präzise Führung der Spindeln. Grosse Präzision in der Positionierung.

Prensa con 4 husillos para colocar las agujas

Tases de material sintético intercambiables.
 Base: Ø 31 mm. Guía de los husillos mejorada.
 Posicionamiento mas preciso.

6173

swiss made

6173-B

Butée micrométrique pour potence à crémaillère
 En acier nickelé. Réglage par vis micrométrique.
 Précision: 0.01 mm par graduation.

Mikrometrischer Anschlag für den Zahnstangen-Pressstock
 Aus vernickeltem Stahl. Regulierung durch Millimeter-
 schraube. Präzision: 0.01 mm Einteilung.

Micrometric stop for rack press
 Nickel-Steel. Adjustment by micrometric screw.
 Precision: 0.01 mm graduation.

Tope micrométrico para potencia con cremallera
 En acero niquelado. Ajuste con un tornillo micrométrico.
 Precisión: 0.01 mm de graduación.

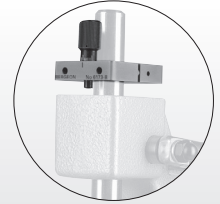
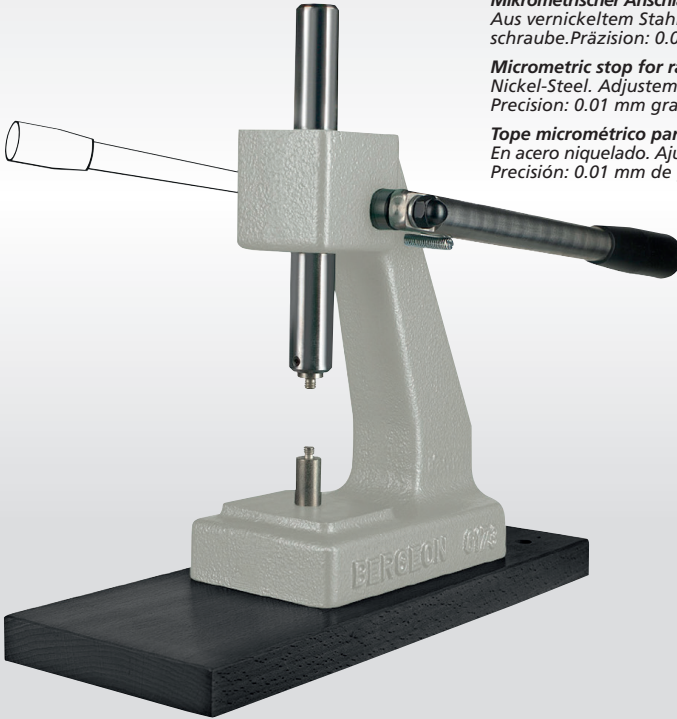

Potence à crémaillère multi-usages

Très adapté pour fermer les fonds à pression.
 Utilisation pour droitiers et gauchers.
 Hauteur travail utile max 110 mm
 Livrée avec 2 support pour tasseaux de 3mm et
 21mm. En option: butée micrométrique

Presstock für vielfältigen Gebrauch

Sehr geeignet zum Schliessen der Druckböden.
 Bedienbar für Rechts- und Linkshänder.
 Zwischenraum max 110 mm.
 Geliefert mit 2 Supporte für Einsätze mit höhe von
 3mm und 21mm. Option: Mikrometrischer Anschlag

Press for multiple uses

Very suitable for closing pressure back cases.
 Operable for right- and left-handed users.
 Working height max. 110 mm.
 Delivered with 2 supports for chucks with usable
 height of 3mm and 21mm.
 Optional: Micrometric stop.

Prensa a cremallera de multiusos

Muy adaptada para cerrar los fondos a presión. Uso
 para diestros y zurdos.
 Altura útil : max. 110mm
 Entregada con 2 soportes para tases de 3mm y
 21mm.
 En opción: tope micrométrico.

8820

swiss made



Extracteur de lunettes tournantes

Extracteur de lunettes tournantes muni d'une pince comportant 4 mors en acier permettant de passer entre la lunette et la boîte de montre, afin d'extraire la lunette.

Abheber für Lünetten

Abheber mit Futter und 4 Stahlbacken zu klammern zwischen dem Uhrgehäuse und die Lunette für die Extraktion der Lunette.

Extractor for Bezels

Bezel extractor with a chuck including 4 steel jaws to clamp between the watchcase and the bezel for extracting the bezel.

Extractor de lunetas giratoria

Extractor de lunetas giratoria provista de un mandril con 4 mordazas en acero que permiten pasar entre la luneta y la caja de reloj para extraer la luneta.

7956

swiss made

EASYCUT

SWISS MADE

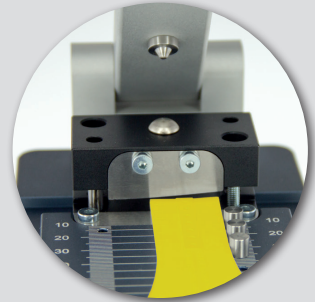
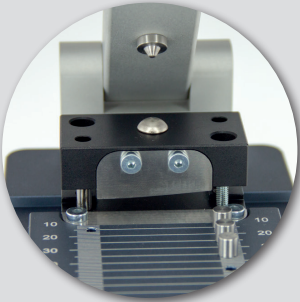
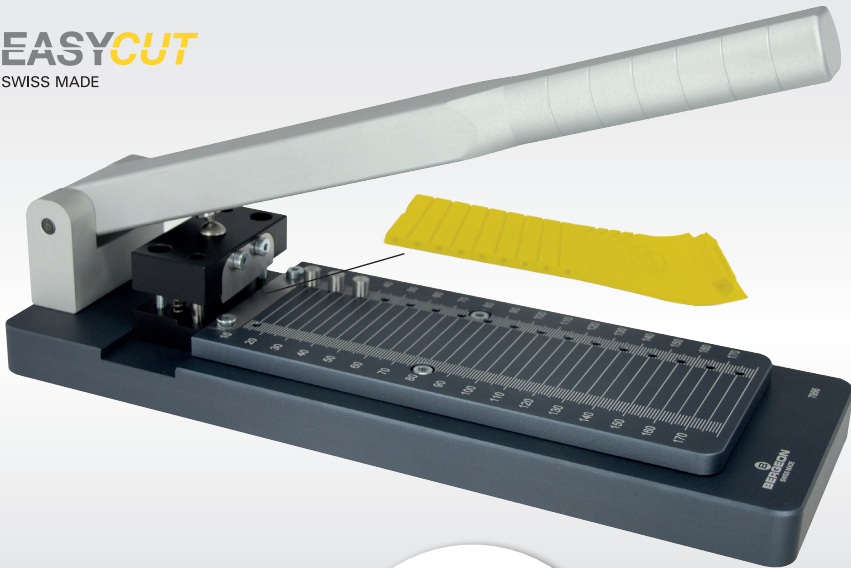

Outil à découper les bracelets

Permet de faire la mise à longueur de bracelets en cuir ou caoutchouc de manière simple et précise.

Stanzwerkzeug für Uhrenarmbänder

Ermöglicht eine einfache und präzise Kürzung von Leder- oder Kunststoffarmbänder.

Tool for cutting the watch straps

Allows an simple and precise cut to length of leather or rubber watch straps.

Dispositivo para cortar las pulseras

Permite de hacer el corte a la longitud de las pulserasde piel y caucho de manera sencilla y precisa.

7819

swiss made



Dispositif pour courber les fermoirs à boucle déployante

Outil permettant de régler la résistance d'ouverture des fermoirs à boucle déployante.

Device for bowing the folding buckles

Tool allowing to adjust the opening resistance of the folding clasp buckles.

Vorrichtung zum Verbiegen der Faltschliesse

Werkzeug zum verstellen des Widerstands der Öffnung von Faltschliessen.

Dispositivo para doblar los cierres despleables

Herramienta que permite de ajustar la resistencia a la apertura de los cierres desplegables.



Outil pour poser et enlever
les barrettes à ressorts

Werkzeug zum Setzen und
Entfernen der Federösen

Tool for fitting and removing
spring-bars

Útil para sacar y colocar pasadores
de muelles

7767-SF



7767-S



7767-F



8111



Pointe réversible
et fourchette en forme de spatule

Serrage des embouts par mandrin.

Umkehrbarer Spitze
und Gabel in Spachtelform

Festschrauben der Einsätze mit Spannfutter.

Reversible point
and spatula-shaped fork

Gripping the pins with a chuck.

Reversible punta
y horquilla en forma de espátula

Sujeción de las puntas por mandril.

QUICK SERVICE
 SWISS MADE

7812



30080-TN



- 6899-M-100
- 6899-M-160
- 6767-A
- 6767-B
- 7230-G08



2510-N



7403



7039

6460-P



7026-00



30081-100

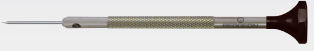

30081-160

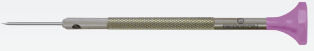

6767-S



7230

swiss made



2611-2.5

6789-G



2819-MINI



Mallette Quick Service

Pour le changement des piles, changement et mise à taille des bracelets.

Contient: 18 outils et accessoires spécialisés.

Quick Service Werkzeugkoffer

Für das Auswechseln der Batterien, das Auswechseln und Kürzen von Armbänder.

Enthält: 18 spezialisierte Werkzeuge und Zubehörteile.

Quick Service Tool Case

For the batteries service, bracelets change and length setting.

Contains: 18 specialized tools and accessories.

Maletín Quick Service

Para cambiar pilas, para cambiar y recortar las pulseras.

Contiene: 18 herramientas y accesorios específicos.

MASTER SERVICE
SWISS MADE



7815

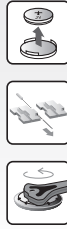

6460-P



7026-1



3153



1282-A



4056-6



2819-08-R

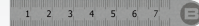

30540



2611-TN-2.5



7039

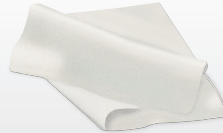

6789-N



6744-P

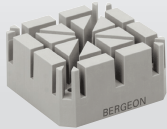

2963-B



6x Ø 15 x 30 mm

8745



2510-N



2819-08

4932



3x
2819-A



3x
2819-B

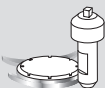

3x
2819-C

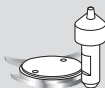

3x
2819-D



6899-T-...



30081-...

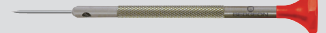

Ø 1.00 - 1.20 - 1.40 - 1.60 - 2.00 mm

Mallette Master Service

Pour le changement des piles et mise à taille des bracelets. Ouverture et fermeture des fonds de boîtes vissés.

Contient: 46 outils et accessoires spécialisés.

Master Service Werkzeugkoffer

Für das Auswechseln der Batterien und Kürzen von Armbänder. Für das Öffnen und Schliessen von geschraubten Gehäuseböden.

Enthält: 46 spezialisierte Werkzeuge und Zubehörteile.

Master Service Tool Case

For the batteries service, bracelets change and length setting. Opening and closing of the screwed back covers. Contains: 46 specialized tools and accessories.

Maletín Master Service

Para cambiar pilas y recortar las pulseras. Apertura y cierre de los fondos de cajas atornillados. Contiene: 46 herramientas y accesorios específicos.

30097-BC

swiss made

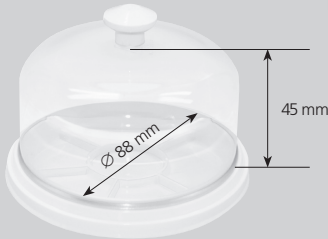

Cloche, plateau et réhaut

Réhaut permettant d'empiler plusieurs plateaux les uns sur les autres et ainsi gagner de la place sur le plan de travail.

Cover, tray and extension cover

The extension cover allows to stack several trays directly on one other to save place on the workbench.



30097-RH

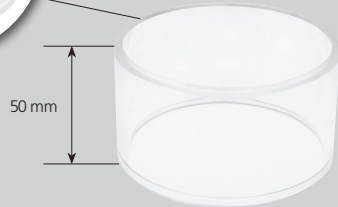

Glocke, Teller und Verlängerungsstück

Das Verlängerungsstück ermöglicht es, mehrere Schalen direkt aufeinander zu stapeln, um weniger Platz auf der Werkbank zu sichern.

Campana y bandeja y realce

El Realce permite apilar varias bandejas el uno del otro y así ahorrar espacio sobre la mesa de trabajo.

30097-XL-BC

swiss made

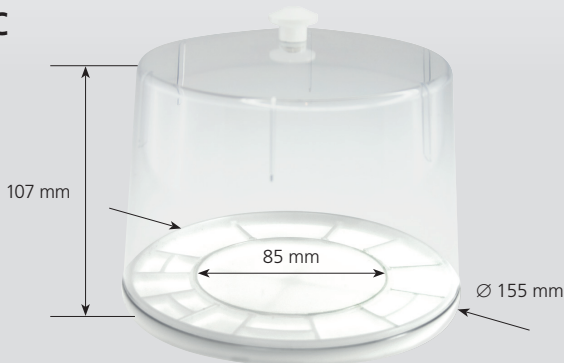

Cloche et plateau XL

17 compartiments de différentes grandeurs, le compartiment central étant dimensionné de manière à recevoir des paniers de lavage ainsi que des coussins d'emboîtement pouvant aller jusqu'à un \varnothing 85 mm.

XL tray and cover

17 trays of various sizes, the central tray can receive cleaning baskets and casing cushions until \varnothing 85 mm.

XL Teller und Glocke

17 verschieden grossen Fächern, das Zentralfach kann Reinigungskörbchen und Einschalungskissen bis zu \varnothing 85 mm aufnehmen.

Campana y bandeja XL

17 compartimentos de diferentes tamaños, el compartimento central está dimensionado para ser capaz de aceptar las cestas a lavar y almohadillas apoya relojes hasta \varnothing 85 mm.

2611-TN-...



Microscope d'horloger

En matière synthétique avec ouverture antibuée et de visibilité.

Watchmaker's eyeglass

Made of synthetic material with anti-mist and sight opening.

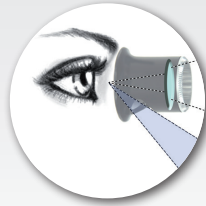

⌕ 6.7x / 5x / 4x / 3.3x / 2.8x / 2.5x

2611-TB-...



Lupe für Uhrmacher

Aus synthetischem Material mit Antibeschlag- und Sicht-Öffnung.

Microscopio de relojero

De material sintético con abertura para la visibilidad y contra el empañado.

7913



⌕ 1.5x / 2.0x / 2.5x / 3.0x / 3.5x / 4.0x

Loupe d'horloger avec pince pour lunettes

Loupe amovible avec pince munie de protections.

Watchmaker Eyeglass with clip for glasses

Removable eyeglass with a protected clip.



Uhrmacher Lupe mit Klammer für Brille

Abnehmbare Lupe mit geschütztem Clip.

Lupa de relojero con pinza para gafas

Lupa extraíble con pinza protegida.

7774

swiss made



Quick Dim

Accessoire pour pied à coulisse digital permettant de mesurer des parois et profondeurs (de la même manière qu'un palpeur).

Quick Dim

Zubehör für digitale Schieblehre, welche die Messung der Tiefe und Kante erlaubt (auf gleiche Weise wie ein Taster).

Quick Dim

Accessory for digital sliding caliper, allowing the measuring of the depth and edge (in the same way then a probe).

Quick Dim

Accesorio para pié de rey digital que permite la medida de paredes y profundidades (de la misma manera que una sonda).

7995

swiss made



Support coq

Permet à l'horloger de disposer le coq et son balancier-spiral de manière à ne pas polluer l'huile se trouvant sur les pivots de l'axe lors de décottages.

Unruhkloben-Stütze

Ermöglicht dem Uhrmacher den Unruhkloben mit seiner Spiralfeder zu platzieren, ohne das Öl des Zapfens der Welle zu verschmutzen, während den Überholungen.

Balance-cock support

Enables the watchmaker to position the balance-cock with his balance-spring, avoiding to pollute the oil on the staff pivot, during the corrections.

Soporte "coq"

Permite que el relojero tenga el puente de volante y el volante de manera de no contaminar el aceite situado en el eje de giro durante las correcciones.

30417



Marteau bi-matériaux

Marteau avec un embout en matière synthétique et l'autre en laiton. Possibilité de remplacer les embouts.

Hammer, bi-Materialien

Hammer mit einem Ende aus synthetischem Material und das andere aus Messing. Die Ende sind ersetzbar.

Hammer bi-materials

Hammer one End in synthetic material and the other in brass. The Ends are replaceable.

Martillo bimaterial

Martillo con una punta en materia sintética y la otra en latón. Puntas reemplazables.

2290

 10 x

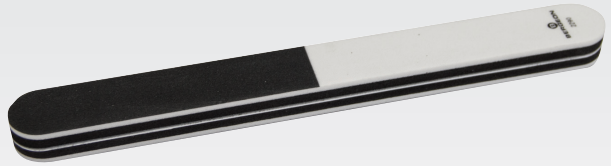

EBAUCHE

POLISH

BERGEON
2290

FINISH



Cabron à aviver

Avec 3 abrasifs différents permettant d'aviver bracelets et boîtes de montres.

Schmirgelfeile zum auffrischen

Mit 3 verschiedenen Schleifmittel anhand welche Armbänder und Uhrgehäuse aufgefrischt werden können.

Buff to polish

With 3 different abrasives allowing to buff bracelets and watch cases.

Pulidores para retoques

Con 3 diferentes granos para retocar las micro rayaduras en las pulseras de metal y cajas de relojes.

1283-A

 swiss made

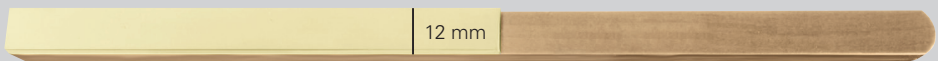

1283-D

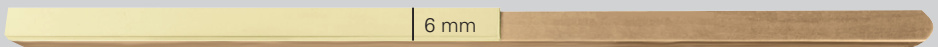













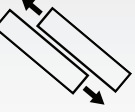









Cabron en peau de chamois

Waschlederfeile

Wash leather buff

Pulidor en piel de gamuza

Caractéristiques des embouts de brucelles
Kenndaten der Korzangspitzen
Characteristics of the tweezers' tips
Características de las puntas de las pinzas

Matériaux Materialien Materials Materiales	 ESD	 (C°) Résistance à la chaleur Hitze Resistenz Heat resistance Resistencia al calor	 Résistance chimique Chemische Resistenz Chemical resistance Resistencia química	 Résistance mécanique Mechanische Resistenz Chemical resistance Resistencia mecánica	Couleur Farbe Color Color
CFR Fibre de carbone Kohlefaser Carbon fiber Fibra de carbono	Conductible Leitfähig  Conductible Conductivo	 130°			
SVR Teflon	Conductible Leitfähig  Conductible Conductivo	 150°			
CPR Carbon Peek	Dissipatif Dissipativ  Dissipative Disipativo	 260°			
DGR Delrin	Isolant Isolierend  Isolating Aislamiento	 85°			



 Excellent
 Ausgezeichnet
 Excellent
 Excelente

 Bon
 Gut
 Good
 Bueno

 Faible
 Schwach
 Poor
 Bajo

6571-CFR-...

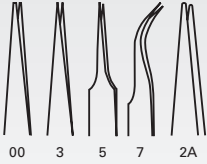
swiss made



CFR



Brucelles à embouts en fibre
de carbone

Kornzange mit Spitzen aus Kohlefaser

Tweezers with carbon fiber tips

Pinzas con puntas en fibra de carbono

6571-SVR-...

swiss made

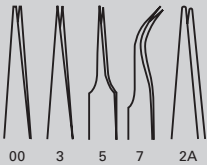

SVR



Brucelles à embouts en Téflon

Kornzange mit Spitzen aus Teflon

Tweezers with tips in Teflon

Pinzas con puntas en Teflón

6571-CPR-...

swiss made

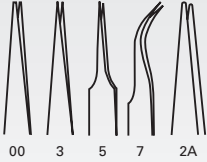

CPR



Brucelles à embouts en Peek

Kornzange mit Spitzen
aus Kunststoff Peek

Tweezers with tips in synthetic
carbon Peek

Pinzas con puntas en Peek

6571-DGR-...

swiss made

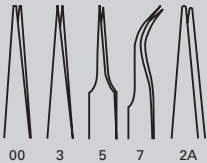

DGR

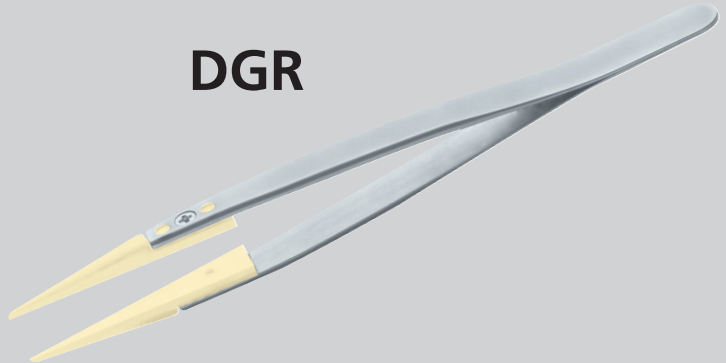

Brucelles à embouts en Delrin blanc

Kornzange mit Spitzen aus weissem
Delrin

Tweezers with tips in white Delrin

Pinzas con puntas en Delrin blanco

7572-ESD-...

swiss made

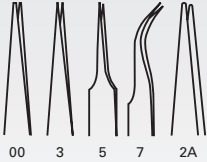

ESD



Brucelles ESD revêtue d'une membrane caoutchouc-nitrile

Manche revêtu d'une membrane en caoutchouc-nitrile vulcanisé, très résistante. ESD Safe dissipatif.

ESD Kornzange mit einer Nitril-Kautschuk Membran beschichtet

Griff überzogen mit einer Membran aus vulkanisiertem Nitril-Kautschuk, sehr widerstandsfähig. Dissipativ ESD Safe.

ESD tweezers coated with nitrile rubber membrane

Grip coated with a vulcanized nitrile rubber membrane, very resistant. Dissipative ESD Safe.

Pinzas ESD cubiertas de una membrana de caucho de nitrilo

Mango cubierto con una membrana de caucho de nitrilo vulcanizado, muy resistente. ESD Safe disipativo.

7571-DC-...

swiss made

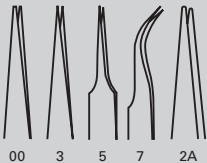

DC



Brucelles à pointes durcie par traitement carbone

Pointes revêtues d'une fine couche de carbone développant une structure cristalline semblable à un diamant naturel. Dureté très élevée: jusqu'à 80 GPa.

Kornzange mit gehärteten Spitzen durch eine Kohlenstoffbehandlung

Spitzen überzogen mit einer dünnen Kohlenstoff Schicht entfaltet eine Kristallstruktur, welche einem Naturdiamanten ähnelt. Sehr hohe Härte: bis zu GPa.

Tweezers with hardened tips by diamond coating

Tips coated with a thin carbon layer, developing a crystalline structure similar to a natural diamond. Very high level of hardness: until 80 GPa.

Pinzas con puntas endurecidas con tratamiento de carbono

Puntas recubiertas de una capa delgada de carbono desarrollando una estructura cristalina similar a un diamante natural. Dureza muy alta: hasta 80 GPa.

6571-BUR-3

+ swiss made



Brucelles avec pointes en bois

Densité élevée pour manipuler les composants.

Kornzange mit Spitzen aus Holz

Hohe Dichte für die Handhabung der Bestandteile.

Tweezers with points in wood

High density to handle the components.

Pinzas con puntas en madera

Alta densidad para manipular los componentes.

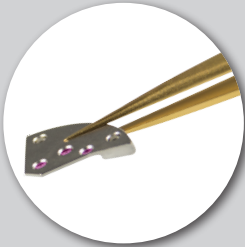

7029-1AM

+ swiss made



7029-2AM

Brucelles avec flash d'or

En laiton, revêtues d'un flash d'or.
Le dorage protège de l'oxydation et préserve de l'odeur particulière du laiton

Kornzangen mit Gold-Flash

Aus Messing mit einer Gold-Flash-Beschichtung.
Die Vergoldung schützt vor der Oxidierung und bewahrt vor dem besonderem Geruch des Messings.

Tweezers with Gold flash

Brass, coated with a gold flash.
The coating protects against oxidation and preserves of the particular smell of the brass.

Pinzas con oro flash

Latón, chapeado oro flash.
El dorado protege de la oxidación y preserva del olor particular del latón.

Brucelles

Kornzangen

Tweezers

Pinzas

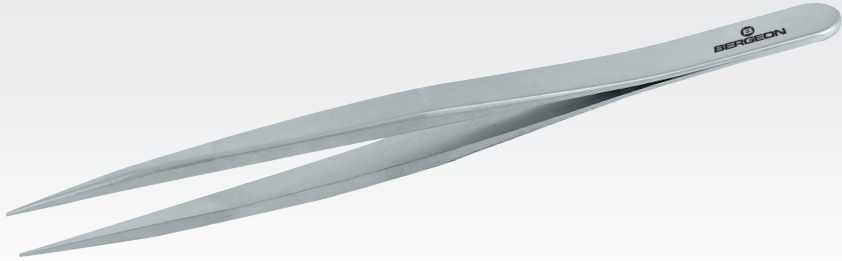

B*JET*

 swiss made

7024  1/2/3/4/5/AA

Acier antimagnétique, finition standard.
Convient pour les travaux nécessitant une
précision moindre.

Antimagnetischer Stahl, gängige Ausführung.
Vorgesehen für Arbeiten welche geringe Präzision
benötigen.

Nonmagnetic steel, common finish.
Suits for works with a minor precision needed.

Acero antimagnético, acabado estándar. Adecuado
para trabajos que requieren menos precisión.

B*C*

 swiss made

7026  0/00/1/2/3/3C/4/5/6/7/AA/F/S/SS

Acier antimagnétique, antiacide, finition soignée.
Bonne résistance à la corrosion.

Antimagnetischer Stahl, säurebeständig, gepflegte
Verarbeitung. Guten Widerstand auf Korrosion.

Nonmagnetic steel, acid-resistant, trimmed finish.
Good resistance to corrosion.

Acero antimagnético, antiácido, acabado limpio.
Buena resistencia a la corrosión.

BVOX

swiss made

7027 ➤ 0/00/1/2/3/3C/4/5/6/7/7A/15A/AA/F/S/SS

Acier INOX, finition soignée.
Recommandé pour sa dureté.

Edelstahl, gepflegte Verarbeitung.
Empfehlenswert für Ihre Härte.

Stainless steel, trimmed finish.
Recommended for its hardness.

Acero inoxidable, acabado limpio.
Recomendado por su dureza.

BXEL

swiss made

7025 ➤ 0/1/2/3/3C/4/5/6/7/11/AA/SS

Acier antimagnétique, antiacide, alliage "haute qualité", finition soignée.
Très bonne résistance à la corrosion, à la chaleur (450°), aux acides et 100% antimagnétique.

Antimagnetischer Stahl, säurebeständig, "hochwertige Qualität" Legierung, gepflegte Verarbeitung.
Sehr hohen Widerstand auf Korrosion, auf Hitze (450°), auf Säure und 100% antimagnetisch.

Nonmagnetic steel, acid-resistant, "high quality" alloy, trimmed finish.
Very good resistance to corrosion, heat (450°), acids and 100% nonmagnetic.

Acero antimagnético, antiácido, aleación "alta calidad" acabado limpio.
Muy Buena Resistencia a la corrosión y al calor (450°), ácidos y 100% antimagnético.

B★

swiss made

7028 ➤ 0/1/2/3/3C/4/5/6/7/AA/F/S/SS

Superalloy (Ni-Cr-Mo), antimagnétique, antiacide, finition soignée. Dureté jusqu'à 6 fois supérieur aux aciers antimagnétiques "communs", résistance à la corrosion, à la chaleur (800°), 100% antimagnétique.

Superlegierung (Ni-Cr-Mo), antimagnetisch, säurebeständig, gepflegte Verarbeitung. Bis zu 6 Mal härter als „gewöhnliche“ antimagnetische Stähle, Widerstand auf Korrosion, auf Hitze (800°) und 100% antimagnetisch.

Superalloy (Ni-Cr-Mo), nonmagnetic, acid-resistant, trimmed finish. Until 6 times harder than "common" nonmagnetic steels, resistant to corrosion, heat (800°) and 100% nonmagnetic.

Superalloy (Ni-Cr-Mo) antimagnético, antiácido, acabado limpio. Dureza hasta 6 veces superior a los comunes ácidos antimagnéticos, resistencia a la corrosión, al calor (800°), 100% antimagnético.

7284-...



Trame de fils d'argent
Silbernen Einschlagfaden
Nano silver yarn wefts
Cuadrados de hilo de plata



S - M - L - XL



Blouse d'horloger antistatique avec fils d'argent

Trois poches, double col, fermeture avec boutons pression, poignets réglables avec boutons pression. Tissu mixte: 63% polyester, 35% coton et 2% de fil d'argent.

Très légères et confortables, couleur blanche quadrillée avec trame de fils d'argent. Antibactérien.

Uhrmacherkittel antistatisch mit Silberfäden

3 Taschen, Doppelkragen, Druckknopfverschluss, Manschetten mit Druckknöpfen regulierbar. Gewebe aus : 63% Polyester, 35% Baumwolle und 2% Silberfaden.

Sehr leicht und komfortabel, Farbe: weiss kariert mit silbernen Einschlagfaden. Antibakteriell.

Antistatic coat for watchmaker nano silver yarn

Three pockets, double collar, pressure buttons, adjustable wrists with pressure buttons. Mixed fabrics: 63% polyester, 35% cotton and 2% nano silver yarn. Very light and comfortable, white plaid color with nano silver yarn wefts. Antibacterial.

Bata de relojero antiestática con hilo de plata

Tres bolsillos, cuello camisa, cierre mediante corchetes, ajuste de mangas con corchetes. Tejido mixto de 63% poliéster, 35% algodón y 2% de hilo de plata. Muy ligeras y confortables, color blanco con cuadrados de hilo de plata. Antibacteriano.

2208

330 x 330 mm

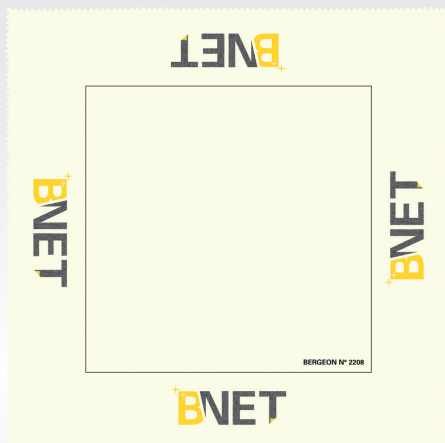

Tissu B-Net

250 g/m2, 70% polyester, 30% polyamide.
Lavable à 40° C.

B-Net Tuch

250 g/m2, 70% Polyester, 30% Polyamid.
Zu 40° C waschbar.

B-Net cloth

250 g/m2, 70% polyester, 30% polyamide.
Washable to 40° C.

Tejido B-Net

250 g/m2, 70% poliéster, 30% poliamida.
Lavable a 40° C.

7854-20

300 x 300 mm

 20 x

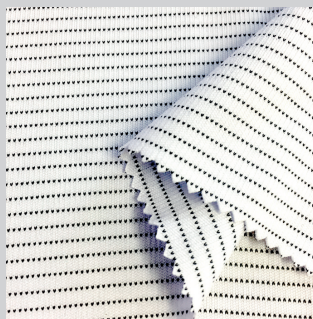

Tissu microfibre antistatique blanc avec fils d'argent

240 g/m2, 80% polyester, 20% polyamide.

Weisses antistatisches Mikrofasergerewebe mit Silberfäden

240 g/m2, 80% Polyester, 20% Polyamid.

White antistatic microfiber fabric with silver yarn

240 g/m2, 80% polyester, 20% polyamide.

Tejido 100% microfibra antiestático blanco con hilo de plata

240 g/m2, 80% poliéster, 20% poliamida.

7853-20

300 x 300 mm

 20 x



Tissus microfibre blanc

240 g/m², 80% polyester, 20% polyamide.

Weisses Mikrofaser Gewebe

240 g/m², 80% Polyester, 20% Polyamid.

White microfiber wipers

240 g/m², 80% polyester, 20% polyamide.

Tejido de microfibra

240 g/m², 80% poliéster, 20% poliamida.

7164-050

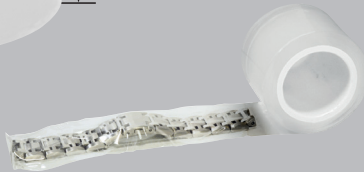
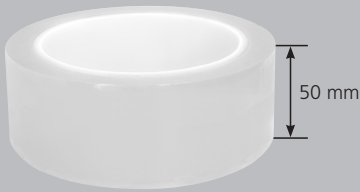

Film de protection

Pour l'emballage de montres, bijoux ou autres produits de luxe. Conforme aux normes REACH.

Protective Film

For packaging of watches, jewels or other luxury items. According to the REACH norms.

7164-080

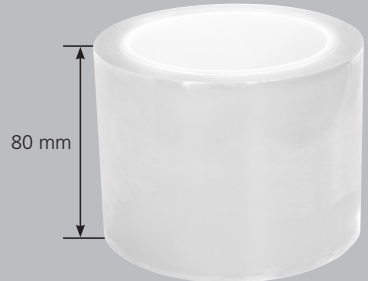

Schutzfilm

Zum Verpacken von Uhren, Schmuck, Luxus Artikeln. Entspricht REACH

Film de protección

Para protección de relojes, joyas o otros productos de lujo. Cumple con las normas REACH.

7861



S - M - L - XL

Gants en microfibre

Très résistants, non imprégnés. Particulièrement utilisés en boutique pour nettoyer, polir et manipuler tous types de verres, métaux précieux ainsi que les pierres précieuses et semi-précieuses. Lavable à 40° C.

Original Mikrofaser Handschuhe

Sehr widerstandsfähig, nicht imprägniert. Besonders geeignet in Geschäft zum Reinigen, Polieren und Handhaben aller Gläserarten, metallische Uhren und Armbänder wie die Edelmetallen und Halbmetallen sowie Edelsteinen. Waschbar bei 40°C.

Gloves in microfibres

Highly resistant, non-impregnated. Very useful in shop to clean, to polish and to operate all kinds of glasses, metal watches and bracelets as well precious, semi-precious metals and precious stones. For dry use or with a cleaning product. Washable at 40°C.

Guantes de microfibra

Muy resistente, non impregnada. Particularmente utilizada en tienda para limpiar, pulir y manipular todos los tipos de vidrios, lojes y pulseras metálicos así como metales preciosos y medio-preciosos así que las piedras preciosas. Se puede lavar a 40°C.

6886-AS-...-144



M - L -XL



Doigtiers

Paquet de 144 doigtiers antistatique en caoutchouc et sans poudre.

Fingerlinge

Beutel à 144 antistatischen Gummifingerlinge ohne Puder.

Thimbles

Pack of 144 antistatic rubber thimbles without powder.

Dediles

Bolsa de 144 dediles antiestáticos en caucho, sin polvo.

6886-SP-...-144



M - L -XL



Doigtiers

Paquet de 144 doigtiers en caoutchouc sans poudre.

Fingerlinge

Beutel à 144 Gummifingerlinge ohne Puder.

Thimbles

Pack of 144 rubber thimbles without powder.

Dediles

Bolsa de 144 dediles en caucho, sin polvo.

5840-...-144



M - L - XL



Doigtiers

Paquet de 144 doigtiers en caoutchouc légèrement poudré.

Fingerlinge

Beutel à 144 Gummifingerlinge leicht gepudert.

Thimbles

Pack of 144 rubber thimbles lightly powdered.

Dediles

Bolsa de 144 dediles en caucho, ligeramente empolvados.

7872



Distributeur de doigtiers plexiglas

Fingerlinge-Spender Plexiglas

Thimbles dispenser acrylic glass

Dispensador de dediles pléxiglas

8500-KIT-MEC

swiss made



Kit de lubrifiants MOEBIUS pour montres mécaniques

9104/5 ml	Rouage, frictions acier/acier
9415/2 ml	Echappement
9504/5 ml	Frictions très élevées
9010/2 ml	Rouage
9501/5 ml	Frictions mise à l'heure

MOEBIUS Schmiermittel-Kit für mechanische Uhren

9104/5 ml	Räderwerk, Reibungen Stahl/Stahl
9415/2 ml	Hemmung
9504/5 ml	Sehr hohe Reibungen
9010/2 ml	Räderwerk
9501/5 ml	Reibungen Zeigerstellung

MOEBIUS lubricant kit for mechanical watches

9104/5 ml	Train, frictions steel/steel
9415/2 ml	Escapment
9504/5 ml	Very high frictions
9010/2 ml	Train
9501/5 ml	Frictions hand setting

Kit de lubricantes MOEBIUS para relojes mecánicos

9104/5 ml	Tren de ruedas, fricción acero/acero
9415/2 ml	Escape
9504/5 ml	Fricciones muy elevadas
9010/2 ml	Tren de ruedas
9501/5 ml	Fricciones puesta en hora

8500-KIT-QUA

swiss made



Kit de lubrifiants MOEBIUS pour montres à quartz

9501-SC/5 ml	Frictions mise à l'heure
9104-SC/2 ml	Micro moteur
8302/5 ml	Graisse pour mécanisme
9014/2 ml	Rouage
8212-SC/5 ml	Graisse naturelle molle pour aluminium, faible freinage

MOEBIUS Schmiermittel-Kit für Quartz Uhren

9501-SC/5 ml	Reibungen Zeigerstellung
9104-SC/2 ml	Mikromotor
8302/5 ml	Fett für Mechanismus
9014/2 ml	Räderwerk
8212-SC/5 ml	Natürliches weiches Fett für Aluminium, Schwache Bremswirkung

MOEBIUS lubricant kit for quartz watches

9501-SC/5 ml	Frictions hand setting
9104-SC/2 ml	Micromotor
8302/5 ml	Grease for mechanism
9014/2 ml	Train
8212-SC/5 ml	Natural soft grease for aluminium, weak braking

Kit de lubricantes MOEBIUS para relojes de cuarzo

9501-SC/5 ml	Fricciones puesta en hora
9104-SC/2 ml	Micromotor
8302/5 ml	Grasa para mecanismo
9014/2 ml	Tren de ruedas
8212-SC/5 ml	Grasa suave y natural para aluminio, bajo frenaje

76835-4-120

swiss made

76835-4-230

witschi



New watch expert IV

Appareil de contrôle performant et universel pour les montres mécaniques.

New watch expert IV

Zukunftsorientierte Technologie zum Prüfen von mechanischen Uhren.

New watch expert IV

The versatile and efficient test instrument for mechanical watches.

New watch expert IV

Aparato de control muy eficiente y universal para los relojes mecánicos.



Retrouvez tous nos produits en ligne
Finden Sie alle unsere Produkte online
Find all our products online
Encuentre todos nuestros productos online

www.bergeon.ch



Images non contractuelles - Nicht-vertragliche Bilder - Non binding pictures - Imágenes no contractuales

Outillages et équipements pour l'horlogerie, la bijouterie et la microtechnique

BERGEON SA
11, av. du Technicum
CH - 2400 Le Locle

Tél. + 41 32 933 60 00
Fax + 41 32 933 60 01

www.bergeon.ch
info@bergeon.ch