



# News

**BASELWORLD**

08.03 - 15.03.2012

Hall | Stand  
**3u | D20**



**BERGEON**

Depuis 1791



Des milliers de références disponibles  
en tout temps  
*Tausende von Artikeln jederzeit verfügbar*  
Thousands of items available at all time  
*Millares de referencias disponibles*  
en cualquier momento

### Site Internet

comprenant:

- Shop en ligne, téléchargements
- Vidéos, fiches techniques
- Informations générales

### Web Seite umfasst:

- Shop on ligne,
- Unterladen von vidéos, technische Daten
- Allgemeine Informationen

### Web site containing:

- On Line shop,
- Downloading videos, technical datas
- General informations

### Portal Internet

que incluye:

- Shop en línea, descargas,
- Vídeos, fichas técnicas
- Información general

[www.bergeon.ch](http://www.bergeon.ch)



Produits catalogués et destinés au SAV horlogerie et bijouterie, livrés dans le monde entier.

*Cataloged Produkte sind für den Service schauen soll und Schmuck weltweit ausgeliefert.*

Cataloged products are intended for service watch and jewelry delivered worldwide.

*Productos catalogados y destinados al SAV relojería y joyería, suministrados en todo el mundo.*

Une entreprise tournée vers le futur  
*Ein Unternehmen mit Blick in die Zukunft*  
A company looking in to the future  
*Una empresa vuelta hacia el futuro*



### R&D, en collaboration avec vos Bureaux méthodes, SAV, et industrialisation

- Prise en charge de vos contraintes
- Evolution possibles en cours de projet

### *R+D, in Zusammenarbeit mit Ihren Kundendiensten, und technische Abteilung und Industrialisierung*

- *Integrierung Ihre Vorzüge*
- *Evolution jederzeit möglich*

### R&D, in cooperation with your After sales service, method office and industrialization

- Taking care of your restraints
- Possible evolution while a project in process

### *R+D, en colaboración con sus Oficinas métodos, SAV, e industrialización*

- Tomada a cargo de sus dificultades
- Evolución posibles en curso de proyecto

### Usinage/fabrication

- CNC
- Gravage laser
- Assemblage

### *Herstellung/Produktion*

- *CNC*
- *Lasergravierung*
- *Montage*

### Machining/Production

- CNC
- Laser engraving
- Assembling

### *Elaboración/fabricación*

- *CNC*
- *Gravaje láser*
- *Montaje*





# BERGEON

Depuis 1791

Tél. + 41 32 933 60 00  
Fax + 41 32 933 60 01

www.bergeon.ch  
info@bergeon.ch

## Tournevis ergonomiques en acier inox

Corps: Acier inox.  
Manche: Garnitures élastomère TPE.  
Tête: En matière synthétique POM autolubrifiant.  
Mèches: Acier inox durci.

## Ergonomischen Schraubenziehern in Edelstahl

Schaft: Edelstahl.  
Überzug: Elastomer TPE.  
Kopf: aus synthetischem Material POM, selbstschmierend.  
Klingen: Edelstahl gehärtet.

## Ergonomic screwdrivers in stainless steel

Shank: Stainless steel.  
Handle: TPE elastomer coat.  
Head: Self-lubricating, synthetic POM material.  
Blades: Hardened stainless steel.

## Destornilladores ergonómicos en acero inoxidable

Cuerpo: Acero inoxidable.  
Mancha: Guarnición elastómero TPE.  
Cabeza: de materia sintética POM autolubrificante.  
Mechas: De acero inoxidable endurecido.



Ø 67 mm

 SWISS MADE



Ø 90 mm

### Jeu de 9 tournevis sur socle tournant.

Avec emplacement pour les mèches de rechange.

### Drehbare Sockel mit 9 Schraubenziehern.

Markierten Reservoiren für Ersatzklingen.

### Rotating stand with 9 screwdrivers.

Coloured slots for spare blades.

### Surtido de 9 destornilladores sobre zócalo giratorio.

Con emplazamiento para las mechas de recambio.

Ø 0.50 - 0.60 - 0.80 - 1.00 - 1.20 - 1.40 - 1.60 - 2.00 - 2.50 mm.

### Jeu de 10 tournevis sur socle tournant.

Avec emplacements pour les tubes et mèches de rechange.

### Drehbare Sockel mit 10 Schraubenziehern.

Markierten Reservoiren für Ersatzklingen.

### Rotating stand with 10 screwdrivers.

Coloured slots for spare blades.

### Surtido de 10 destornilladores sobre zócalo giratorio.

Con emplazamiento para las mechas de recambio.

Ø 0.50 - 0.60 - 0.80 - 1.00 - 1.20 - 1.40 - 1.60 - 2.00 - 2.50 - 3.00 mm.

No 6899-S09

274 gr.

Pce Fr.

No 6899-S10

685 gr

Pce Fr.



### Assortiment de 5 tournevis.

Mèches de rechange en tubes plastique. En étui bois.

### Sortiment von 5 Schraubenziehern.

Ersatzklinge in Plastiktuben. In Holzetui.

### Assortment of 5 screwdrivers.

With spare blades in plastic tubes. In wooden case.

### Surtido de 5 destornilladores.

Mecha de recambio en tubitos de plástico. En estuche de madera.

Ø 0.50 - 0.60 - 0.80 - 1.00 - 1.20 mm.



### Assortiment de 10 tournevis.

Mèches de rechange en tubes plastique. En étui bois.

### Sortiment von 10 Schraubenziehern.

Ersatzklinge in Plastiktuben. In Holzetui.

### Assortment of 10 screwdrivers.

With spare blades in plastic tubes. In wooden case.

### Surtido de 10 destornilladores.

Mecha de recambio en tubitos de plástico. En estuche de madera.

Ø 0.50 - 0.60 - 0.80 - 1.00 - 1.20 - 1.40 - 1.60 - 2.00 - 2.50 - 3.00 mm.



No 6899-A05

150 gr.

Pce Fr.



No 6899-A10

350 gr.

Pce Fr.



# BERGEON

Depuis 1791

Tél. + 41 32 933 60 00

Fax + 41 32 933 60 01

www.bergeon.ch

info@bergeon.ch

## Tournevis ergonomiques entièrement en acier inoxydables

Corps et manche en acier inox durci.

Tête en matière synthétique POM (Delrin) autolubrifiant.

Mèches en acier inox durci.

## Ergonomischer Schraubenziehern gänzlich aus Inox

Schaft und Überzug aus Edelstahl.

Kopf aus synthetischem Material

POM (Delrin), selbstschmierend.

Klingen aus Edelstahl gehärtet.

## Entirely stainless steel ergonomic screwdrivers

Shank and handle in stainless steel.

Head in self-lubricating, synthetic POM (Delrin) material.

Blades in hardened stainless steel.

## Destornilladores ergonómicos en acero inoxidable

Cuerpo y mango en acero inoxidable endurecido.

Cabeza en materia sintética POM delrin autolubrificante.

Mechas en acero inoxidable endurecido



Ø 67 mm

 SWISS MADE



Ø 90 mm

### Jeu de 9 tournevis sur socle tournant.

Avec emplacement pour les mèches de rechange.

### Drehbare Sockel mit 9 Schraubenziehern.

Markierten Reservoiren für Ersatzklingen.

### Rotating stand with 9 screwdrivers.

Coloured slots for spare blades.

### Surtido de 9 destornilladores sobre zócalo giratorio.

Con emplazamiento para las mechas de recambio.

Ø 0.50 - 0.60 - 0.80 - 1.00 - 1.20 - 1.40 - 1.60 - 2.00 - 2.50 mm.

### Jeu de 10 tournevis sur socle tournant.

Avec emplacements pour les tubes et mèches de rechange.

### Drehbare Sockel mit 10 Schraubenziehern.

Markierten Reservoiren für Ersatzklingen.

### Rotating stand with 10 screwdrivers.

Coloured slots for spare blades.

### Surtido de 10 destornilladores sobre zócalo giratorio.

Con emplazamiento para las mechas de recambio.

Ø 0.50 - 0.60 - 0.80 - 1.00 - 1.20 - 1.40 - 1.60 - 2.00 - 2.50 - 3.00 mm.

No 30081-S09

320 gr.

Pce Fr.

No 30081-S10

930 gr

Pce Fr.



### Assortiment de 5 tournevis.

Mèches de rechange en tubes plastique. En étui bois.

### Sortiment von 5 Schraubenziehern.

Ersatzklinge in Plastiktuben. In Holzetui.

### Assortment of 5 screwdrivers.

With spare blades in plastic tubes. In wooden case.

### Surtido de 5 destornilladores.

Mecha de recambio en tubitos de plástico. En estuche de madera.

Ø 0.50 - 0.60 - 0.80 - 1.00 - 1.20 mm.



### Assortiment de 10 tournevis.

Mèches de rechange en tubes plastique. En étui bois.

### Sortiment von 10 Schraubenziehern.

Ersatzklinge in Plastiktuben. In Holzetui.

### Assortment of 10 screwdrivers.

With spare blades in plastic tubes. In wooden case.

### Surtido de 10 destornilladores.

Mecha de recambio en tubitos de plástico. En estuche de madera.

Ø 0.50 - 0.60 - 0.80 - 1.00 - 1.20 - 1.40 - 1.60 - 2.00 - 2.50 - 3.00 mm.



No 30081-A05

175 gr.

Pce Fr.



No 30081-A10

333 gr.

Pce Fr.



Tél. + 41 32 933 60 00  
Fax + 41 32 933 60 01

**BERGEON**

Depuis 1791

www.bergeon.ch  
info@bergeon.ch

### Tournevis ergonomiques en aluminium

Corps: Aluminium anodisé.  
Manche: Garnitures élastomère TPE.  
Tête: En matière synthétique POM autolubrifiant.  
Mèches: Acier inox durci.

### Ergonomischen Schraubenziehern in Aluminium

Schaft: Eloxiiertes Aluminium.  
Überzug: Elastomer TPE.  
Kopf: aus synthetischem Material POM, selbstschmierend.  
Klingen: Edelstahl gehärtet.

### Ergonomic screwdrivers in aluminium

Shank: Anodized aluminium.  
Handle: TPE elastomer coat.  
Head: Self-lubricating, synthetic POM material.  
Blades: Hardened stainless steel.

### Destornilladores ergonómicos en aluminio

Cuerpo: Aluminio anodizado.  
Mancha: Guarnición elastómero TPE.  
Cabeza: de materia sintética POM autolubrificante.  
Mechas: De acero inoxidable endurecido.



Ø 67 mm

SWISS MADE



Ø 90 mm

#### Jeu de 9 tournevis sur socle tournant.

Avec emplacement pour les mèches de rechange.

#### Drehbare Sockel mit 9 Schraubenziehern.

Markierten Reservoiren für Ersatzklingen.

#### Rotating stand with 9 screwdrivers.

Coloured slots for spare blades.

#### Surtido de 9 destornilladores sobre zócalo giratorio.

Con emplazamiento para las mechas de recambio.

Ø 0.50 - 0.60 - 0.80 - 1.00 - 1.20 - 1.40 - 1.60 - 2.00 - 2.50 mm.

#### Jeu de 10 tournevis sur socle tournant.

Avec emplacements pour les tubes et mèches de rechange.

#### Drehbare Sockel mit 10 Schraubenziehern.

Markierten Reservoiren für Ersatzklingen.

#### Rotating stand with 10 screwdrivers.

Coloured slots for spare blades.

#### Surtido de 10 destornilladores sobre zócalo giratorio.

Con emplazamiento para las mechas de recambio.

Ø 0.50 - 0.60 - 0.80 - 1.00 - 1.20 - 1.40 - 1.60 - 2.00 - 2.50 - 3.00 mm.

No 7899-S09

320 gr.

Pce Fr.

No 7899-S10

930 gr

Pce Fr.



#### Assortiment de 5 tournevis.

Mèches de rechange en tubes plastique. En étui bois.

#### Sortiment von 5 Schraubenziehern.

Ersatzklinge in Plastiktuben. In Holzetui.

#### Assortment of 5 screwdrivers.

With spare blades in plastic tubes. In wooden case.

#### Surtido de 5 destornilladores.

Mecha de recambio en tubitos de plástico. En estuche de madera.

Ø 0.50 - 0.60 - 0.80 - 1.00 - 1.20 mm.



#### Assortiment de 10 tournevis.

Mèches de rechange en tubes plastique. En étui bois.

#### Sortiment von 10 Schraubenziehern.

Ersatzklinge in Plastiktuben. In Holzetui.

#### Assortment of 10 screwdrivers.

With spare blades in plastic tubes. In wooden case.

#### Surtido de 10 destornilladores.

Mecha de recambio en tubitos de plástico. En estuche de madera.

Ø 0.50 - 0.60 - 0.80 - 1.00 - 1.20 - 1.40 - 1.60 - 2.00 - 2.50 - 3.00 mm.



No 7899-A05

130 gr.

Pce Fr.



No 7899-A10

310 gr.

Pce Fr.



# BERGEON

Depuis 1791

Tél. + 41 32 933 60 00  
Fax + 41 32 933 60 01

www.bergeon.ch  
info@bergeon.ch

## Tournevis dynamométriques

Destiné à la production et au SAV horloger ou à la microtechnique; réglable au moyen d'une clef spéciale par l'intérieur (évite tout dérèglement intempêtif).

Système à Adaptateur Changement Rapide (ACR) permettant de passer en quelques secondes d'un Ø X à un Ø Y de mèches, tout en maintenant le couple de serrage.

### Caractéristiques techniques:

Couple de 5 à 55 mNm  
Répétabilité +/- 3 %  
Poids, 20 gr  
Ø 10 mm  
Longueur 85 mm  
Testés à 10'000 déclenchements  
6 déclenchements par tour

Des mèches HSS 0.5 à 2.00 sont également disponibles ainsi que des bagues de couleur permettant l'identification du Ø de la meche ou du couple de serrage.

Cet outil est livré avec un certificat de contrôle.

Les tournevis dynamométriques de type TSE ACR sont livrés sans adaptateur ACR, sans bague d'identification STD (standard), ces fournitures doivent être commandées séparément.

## Dynamometrische Schraubenzieher

Für die Produktion und den Kundenservice in der Uhrmacherei sowie die Mikrotechnik, verstellbar mittels Spezialschlüssel von innen (um ein unabsichtliches Verstellen zu verhindern).

ACR-System (ACR = Adaptateur Changement Rapide) für das sekundenschnelle Wechseln von Einsätzen mit Ø X zu Ø Y, unter Beibehaltung des Anzugsmoments.

### Technische Daten:

Drehmoment von 5 bis 55 mNm  
Wiederholbarkeit +/- 3 %  
Gewicht 20 g  
Ø 10 mm  
Länge 85 mm  
Geprüft mit 10'000 Auslösungen  
6 Auslösungen pro Umdrehung

Auch HSS-Einsätze mit Ø 0.5 bis 2.00 sowie Farbringe zur Kennzeichnung des Einsatz-Ø oder des Anzugsmoments sind verfügbar.

Das Werkzeug wird mit einer Prüfbestätigung geliefert.

Die dynamometrischen Schraubenzieher vom Typ TSE ACR sind ohne Adapter ACR, ohne Identifizierungsring STD (Standard) geliefert, diese Furnituren müssen separat bestellt werden.

## Dynamometric screwdrivers

Designed for watchmaking production and After-Sales services, or for microtechnology; adjustable from the inside by means of a special key (preventing any accidental activation).

Quick Change System (ACR) enabling you to switch from el X to Ø Y blades in a matter of seconds, while maintaining the tightening torque.

### Technical specifications:

Torque range of 5 to 55 mNm  
Repeatability +/- 3 %  
Weight, 20 gr  
Ø 10 mm  
Length 85 mm  
Tested at 10'000 releases  
6 releases per rotation

HSS Ø 0.5 to 2.00 blades are also available, as well as coloured rings for identifying the blades Ø or tightening torque.

This tool is delivered with an inspection certificate.

Dynamometric Screwdrivers type TSE ACR are delivered without ACR Adapter, without STD (standard) Identification rings. These articles have to be ordered separately.

## Destornilladores dynamométricos

Destinado a la producción y al servicio postventa relojero o a la microtécnica; regulable por medio de una llave especial por el interior (evita todo desajuste intempêtivo).

Sistema a adaptador Cambio Rápido (ACR) permitiendo de pasar en algunos segundos de uno Ø X a uno Ø Y de mechas, manteniendo la pareja de presión.

### Características técnicas:

Pareja de 5 a 55 mNm  
Repetitivo +/- 3 %  
Peso, 20 gr  
Ø 10 mm  
Longitud 85 mm  
Testado a 10'000 disparos  
6 disparos por vuelta

Mechas HSS 0.5 a 2.00 son también disponible así como anillos de color que permitiendo la identificación del Ø de la mecha o de la pareja de presión.

Este herramienta es entregada con un certificado de control.







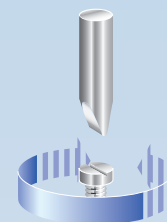

Lo destornilladores dynamométricos son entregados sin adaptador ACR, sin anillo de identificación STD (standard). Estos accesorios deben ser pedidos individualmente.



 SWISS MADE

  
Petitpierre



Déclenchement Auslösung Release Desenganche	Couple Drehmoment Torque range Pareja	A	No	 gr.	Pce Fr./10	Pce Fr.
	5 - 55 mNm		6897-TSE-11	90		
	5 - 55 mNm		6897-TSE-21	90		
	5 - 55 mNm		6897-TSE-31	90		
	20 - 80 mNm		6897-TSE-41	90		

## Adaptateur rapide

En commandant: préciser le Ø de meche: de 0.50 à 2.00 mm.

## Schneller Adapter

Bei Bestellung: Ø der Klinge angeben: von 0.50 bis 2.00 mm.

## Quick change adaptor

When ordering: precise the Ø of the blades: from 0.50 to 2.00 mm.

## Adaptador rápido

Al pedir: indicar el Ø de mecha: de 0.50 a 2.00 mm.



No 6897-AR

15 gr.

Pce Fr.



**BERGEON**

Depuis 1791

Tél. + 41 32 933 60 00  
Fax + 41 32 933 60 01

www.bergeon.ch  
info@bergeon.ch

**Tournevis dynamométriques débrayables de haute précision**

**Type TSE destiné à l'assemblage et au contrôle.**

Très robustes, testés à 10'000 déclenchements. Livrés avec certificat de contrôle. Couple de serrage de 5 à 55 mNm. Grande répétabilité ± 3 %. 6 déclenchements par tour. Le réglage du couple s'effectue à l'aide d'une clef spéciale. Dimensions: Ø 10 x 85 mm.

**Livrés avec:**

- 1 clef pour réglage du couple.
- 1 mode d'emploi.
- **sans bague.**
- **sans douille.**
- **sans mèche.**

Accessoires: voir au verso.

**Dynamométrische Schraubenzieher von grosser Präzision, mit Auskupplung**

**Typ TSE zum Zusammensetzen und für die Kontrolle bestimmt.**

Sehr robust, bei 10'000 Auslösungen geprüft. Wird mit Kontroll-Bescheinigung geliefert.

Drehmoment-Spannung von 5 bis 55 mNm. Bedeutende Wiederholmöglichkeit ± 3 %. 6 Auslösungen per Umdrehung. Die Regulierung des Drehmoments erfolgt mit Hilfe eines speziellen Schlüssels.

Abmessungen: Ø 10 x 85 mm.

**Geliefert mit:**

- 1 Schlüssel zur Spannungsregulierung.
- 1 Gebrauchsanweisung.
- **Ohne Klinge.**
- **Ohne Ring.**
- **Ohne Hülse.**

Zubehörteile: s. Rückseite.

**Dynamometric gearclutch screwdrivers of high precision**

**Type TSE for assembling and testing.**

Very sturdy, tested at 10'000 releases. Delivered with a test certificate.

Torque from 5 to 55 mNm. High performance of repeating ± 3 %. 6 releases per turn. Adjustment of the torque by a special key.

Dimensions: Ø 10 x 85 mm.

**Delivered with:**

- 1 key for torque adjusting.
- 1 direction for use.
- **Without blade.**
- **Without ring.**
- **Without sleeve.**

Accessories: see overleaf.

**Destornilladores dynamométricos desembragable de alta precisión**

**Tipo TSE destinado para el ensamblaje y el control.**

Muy robustos, sometidos a un test de 10'000 desenganches. Entregados con un certificado de verificación.

Par de sujeción de 5 a 55 mNm. Grande repetibilidad ± 3 %. 6 desenganches por vuelta. El ajuste del par se efectua con ayuda de una llave especiala. Dimensiones: Ø 10 x 85 mm.

**Entregados con:**

- 1 llave para ajustar el par.
- 1 modo de empleo.
- **Sin mecha.**
- **Sin anillo.**
- **Sin casquillo.**

Accesorios: ver al verso.

Sens de déclenchement  
Auslösungs-Richtung  
Release direction  
Sentido de desenganche

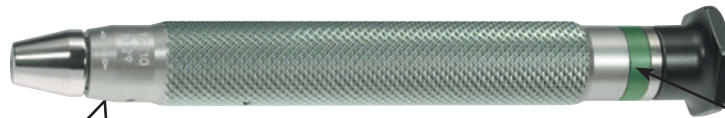

No de série  
Seriennummer  
Serial number  
No de serie

Type  
Typ  
Type  
Tipo



Petitpierre

Bague d'identification  
Identifizierungsring  
Identification ring  
Anillo de identificacion

Déclenchement Auslösung Release Desenganche	No	gr.	Pce Fr. / 10	Pce Fr.
	6895-TSE-10	85		
	6895-TSE-20	85		
	6895-TSE-30	85		

**Type TR destiné à la microtechnique.**

Mêmes caractéristiques que le TSE excepté le réglage qui se fait directement sur le tournevis par l'échelle graduée et le tambour.

**Livrés comme le TSE.**

**Typ TR für die Mikrotechnik bestimmt.**

Gleiche Eigenschaften wie der TSE, aber die Regulierung erfolgt direkt auf dem Schraubenzieher durch die abgestufte Skala und die Trommel.

**Werden wie der TSE geliefert.**

**Type TR, for microtechnic.**

Same characteristics as TSE but the adjustment is directly done on the screwdriver by using the graduated scale and the drum.

**Supplied like the TSE.**

**Tipo TR destinado para la micro-técnica.**

Mismas características que el TSE pero el ajuste se efectua directamente sobre el destornillador por medio de la escala graduada y el tambor.

**Entregados como el TSE.**

Sens de déclenchement  
Auslösungs-Richtung  
Release direction  
Sentido de desenganche

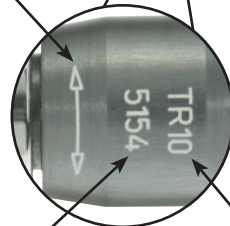

No de série  
Seriennummer  
Serial number  
No de serie

Type  
Typ  
Type  
Tipo

Valeur du couple  
Spannungswert  
Torque measurement  
Valor del par

Tambour  
Trommel  
Drum  
Tambor



Petitpierre

Bague d'identification  
Identifizierungsring  
Identification ring  
Anillo de identificacion

Déclenchement Auslösung Release Desenganche	No	gr.	Pce Fr. / 10	Pce Fr.
	6896-TR-10	75		
	6896-TR-20	75		
	6896-TR-30	75		

Tél. + 41 32 933 60 00  
Fax + 41 32 933 60 01

**B**  
**BERGEON**  
Depuis 1791

www.bergeon.ch  
info@bergeon.ch

### Tournevis dynamométriques

**Avec mèche à changement rapide.**

Réglage direct sur tambour gradué externe.

Destinés au montage et au contrôle dans l'horlogerie, la microtechnique, etc.

Tête à 6 pans, en option bombée.

**Couple de serrage élevé de 10 à 120 mNm.**

Grande répétabilité  $\pm 5\%$ .  
6 déclenchements par tour.  
Douille de réduction  $\varnothing 3$  mm.  
Dimensions:  $\varnothing 13 \times 110$  mm.

Avec bagues d'identification du  $\varnothing$  de la mèche.

**A la commande veuillez préciser: le  $\varnothing$  de la mèche.**

S'utilise avec les accessoires de notre gamme TBP20 / TSE / TR, à l'exception des bagues d'identifications, voir au verso.

### Dynamometrische Schraubenzieher

**Mit Schnellwechsler-Klinge.**

Direktregulierung auf Trommel mit Aussengraduierung.

Bestimmt für die Montage und Kontrolle im Uhrmacherbereich, Mikrotechnik, u.s.w.

Sechseckiger Knopf, zur Wahl auch gewölbt.

**Hohe Drehmoment-Spannung von 10 bis 120 mNm.**

Bedeutende Wiederhol-möglichkeit  $\pm 5\%$ .  
6 Auslösungen pro Runde.  
Redukterhülsen  $\varnothing 3$  mm.  
Abmessungen:  $\varnothing 13 \times 110$  mm.

Mit Identifizierungsring für  $\varnothing$  der Klinge.

**Bei Bestellung anzugeben: den  $\varnothing$  der Klinge.**

Anwensbare Zusatzteile, siehe unsere Serie TBP20 / TSE / TR, mit Ausnahme der Identifikationsringe, siehe Rückseite.

### Dynamometric screwdrivers

**Including blade for quick change.**

Direct adjustment on external graduated drum.

For assembling and checking watch-parts in watchmaking, microtechnology, etc.

Hexagonal head, domed head in option.

**High torque range from 10 to 120 mNm.**

High performance of repeating  $\pm 5\%$ .  
6 releases per turn.  
Reduction sleeves  $\varnothing 3$  mm.  
Dimensions:  $\varnothing 13 \times 110$  mm.

With identification rings for blade  $\varnothing$ .

**When ordering: Indicate the blade  $\varnothing$ .**

Used with our accessories range TBP20 / TSE / TR, except of the identification rings, see overleaf.

### Destornilladores dynamométricos

**Con mechas que se cambia rápidamente.**

Ajuste directo sobre tambor graduado externo.

Destinados para el montaje y para el control en relojería, microtécnica, etc.

Cabeza hexagonal, en opción abombada

**Par de sujeción elevado de 10 a 120 mNm.**

Grande repetabilidad  $\pm 5\%$ .  
6 desenganches por vuelta.  
Casquillos de reducción  $\varnothing 3$  mm.  
Dimensiones:  $\varnothing 13 \times 110$  mm.

Con anillo de identificación para el  $\varnothing$  de la mecha.

**Al pedir: indicar el  $\varnothing$  de la mecha.**

Se utiliza con los accesorios de nuestra gama TBP20 / TSE / TR, al excepción de los anillos de identificaciones, ver al verso.

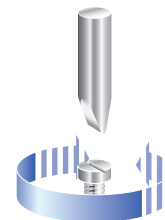
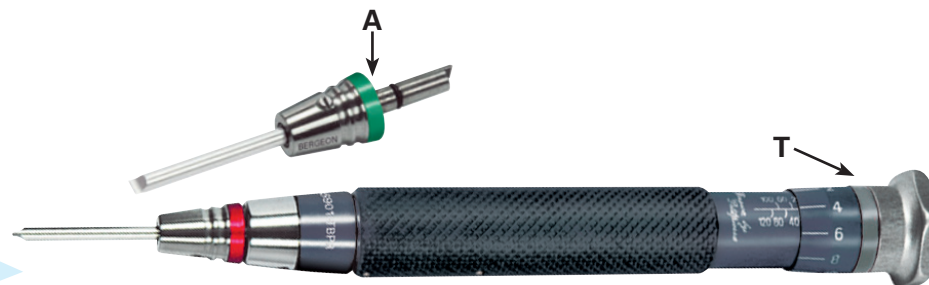
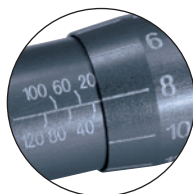
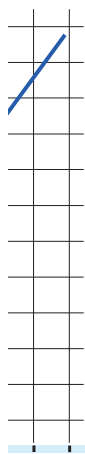

Déclenchement Auslösung Release Desenganche	T	No	gr.	Pce Fr./10	Pce Fr.
	●	6901-TBPR-110	90		
	●	6901-TBPR-120	90		

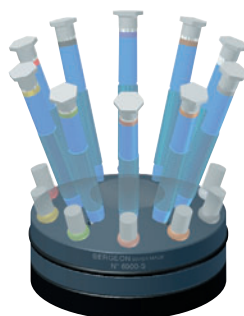

**Socle seul pour  
Sockel allein für  
Stand only for  
Zócalo solo para**

No 6900-TBP20, 6895-TSE et 6896-TR,  
 8017 / 8018 A.

No 6900-S	625 gr.	Pce Fr.
-----------	---------	---------

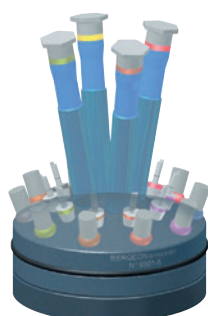

**Socle seul pour  
Sockel allein für  
Stand only for  
Zócalo solo para**

No 6901-TBPR, N-8018-C

No 6901-S	615 gr.	Pce Fr.
-----------	---------	---------



Tél. + 41 32 933 60 00  
Fax + 41 32 933 60 01

**B**  
**BERGEON**  
Depuis 1791

www.bergeon.ch  
info@bergeon.ch

### Couplemètre

Appareil permettant de contrôler ou de mesurer des couples dans le sens horaire ou anti horaire avec lecture analogique.

La fixation des outils s'effectue au moyen des douilles de réduction **No 6895-JD** Ø 0.50 à 2.50 mm, voir page 8018 de notre catalogue.

Utilisation: horlogerie, micromécanique, médical et spatial.

#### Caractéristiques techniques:

Division: 2 mNm  
Précision: 4 %  
Capacité: Ø 0.5 à 3 mm  
Dimensions: Longueur 114 mm  
Ø maxi 27mm  
Ø du corps 11 mm

#### Type d'applications:

- Mesure du couple de friction
- Contrôle du couple de sertissage
- Mesure du couple de dévissage.

### Drehmomentmeßgerät

Gerät zum Prüfen und Messen der Drehmomente im oder gegen den Uhrzeigersinn mit Analog-Meß-Skala. Die Befestigung der Werkzeuge erfolgt mit Hilfe von Verkleinerungsbuchsen **Nr. 6895-JD** Ø 0.50 bis 2.50 mm, siehe Seite 8018 aus unserem Katalog.

Anwendungsbereich: Uhrmacherei, Mikromechanik, Medizin und Raumwissenschaft

#### Technische Angaben:

Unterteilung: 2 mNm  
Präzision :4 %  
Messbereich: Ø 0.5 bis 3 mm  
Größen: Länge 114 mm  
Ø maxim. 27mm  
Ø des Schaftes 11 mm

#### Anwendungsbereich :

- Abmessen des Drehmomentes der Reibung
- Prüfen des Drehmomentes der Fassung
- Abmessen des Drehmomentes der Abschraubung.

### Torque-Tester

Apparatus to check or measure the torque clockwise and reverse with analogical reading. Fixing the tools with reduction sleeves **No 6895-JD** Ø 0.50 to 2.50 mm, see our catalogue's page 8018.

Application: Watchmaking, micro-mechanic, medical and space-research.

#### Technical characteristics:

Division: 2 mNm  
Precision: 4%  
Capacity: Ø 0.5 to 3 mm  
Dimensions: Length 114 mm  
Ø maxi 27 mm  
Ø of the shank 11 mm

#### Type of application:

- Measuring the friction torque
- Checking the setting torque
- Measuring the unscrewing torque.

### Controlor de pares

Aparato para controlar o medir pares en la dirección horario o anti horario con lectura analógica. La fijación de los útiles se realiza con casquillos de reducción **No 6895-JD** Ø 0.50 a 2.50 mm, ver página 8018 de nuestro catálogo.

Utilización: relojería, micromecánica, medicinal y espacial.

#### Características técnicas:

División: 2 mNm  
Precisión: 4%  
Capacidad: Ø 0.5 a 3 mm  
Dimensiones: Largura 114 mm -  
Ø maxi 27 mm -  
Ø del mango 11 mm

#### Tipo de aplicaciones:

- Medida del par de fricción
- Control del par de engastadura
- Medida del par de destornilla.

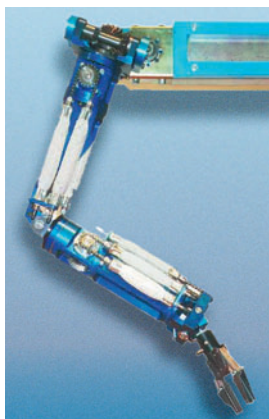
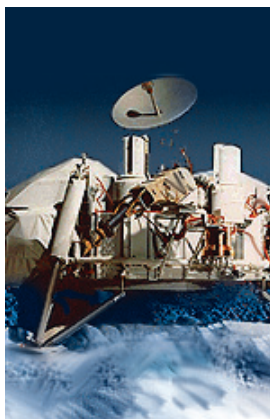

 SWISS MADE

**RP**  
Petitpierre

No	Couple Drehmoment Torque Par	 gr.	Pce Fr.
6960-CM50	0-50 mNm	45	
6960-CM100	0-100 mNm	45	

**B**  
BERGEON  
Technologies



**BERGEON**

Depuis 1791

www.bergeon.ch  
info@bergeon.ch

Tél. + 41 32 933 60 00  
Fax + 41 32 933 60 01

**Appareil à remonter les montres mécaniques et automatiques**

Dispositif d'entraînement de la couronne avec débrayage à la fin du remontage réglable.

Aucun risque de rupture du ressort.

**Geräte zum Aufziehen mechanische und automatische Uhren**

Kronen-Antriebsystem mit Regulierung Rutschkupplung am Ende der Aufziehung.

Ausschluss eines Federbruchs.

**Winding machine for mechanic and automatic watches**

Crown winding system. Clutch slips adjustment at the end of the winding.

No risk of breaking the spring.

**Aparato para dar cuerda a los relojes mecanicos y automaticos**

Dispositivo arrastrador de la corona con desembrague ajustable.

Ningún riesgo de ruptura del muelle



**Caractéristiques techniques**

Entrainement sans à-coup.  
Motorisation DC de grande qualité.

**Technische Angaben**

Antrieb ohne Ruck.  
Motorisierung DC grosser Qualität.

**Technical characteristics**

Drive without jolt.  
DC motorization of great quality.

**Características técnicas**

Arrastre sin interrupción  
Motorización DC de alta calidad

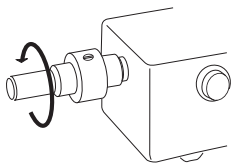

200 Rpm

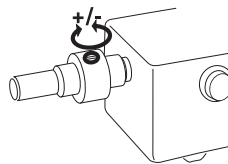

Réglage du débrayage  
Einstellung der Auskupplung  
Adjustment of disengaging  
Arreglo del desembrague

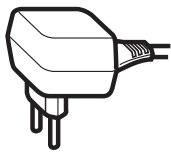

100 - 240 V / 50-60 Hz

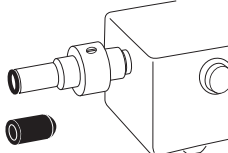

Bague élastomère  
Ring Elastomer  
Ring elastomer  
Anillo elastómero  
**No 4137**

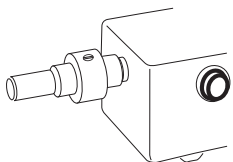

Marche/arrêt à impulsion  
Impuls Ein/Aus  
On/off on impulse  
conectar/desconectar a impulso



<b>No 7047-PRO</b>	1.450 Kg	Pce Fr.
--------------------	----------	---------

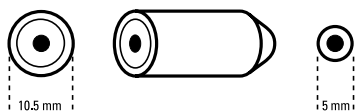

**Tasseaux de rechange - Gummieinsatz - Rubber chuck only - Tás de recambio**

No	gr.	100 pces Fr.	10 pces Fr.	Pce Fr.
4137	2			



# BERGEON

Depuis 1791

Tél. + 41 32 933 60 00  
Fax + 41 32 933 60 01

www.bergeon.ch  
info@bergeon.ch

## Outil pour déchasser et chasser les goupilles de bracelets

L'outil permet de maintenir en bonne position les montres munies de bracelets métalliques afin de chasser et déchasser les goupilles de bracelet.

L'outil comporte divers ajustements permettant de centrer la goupille dans l'axe de la broche et est muni de dégagements pour l'évacuation des goupilles.

Protection caoutchouc sur la surface de travail.

Dimensions: 160 x 120 x 100 mm.

## Werkzeug zum Einpressen und Ausstossen der Armbandstifte

Das Werkzeug ermöglicht das Halten von Uhren mit Metallarmbändern in der gewünschten Stellung, um die Bandstifte einzupressen oder auszustossen.

Ausgestattet mit Auffangspalten für die Stifte weist das Werkzeug diverse Einstellmöglichkeiten auf, um die Bandstifte genau kozentrisch zum Ausstossstift anzuordnen.

Mit Gummischutz auf der Arbeitsfläche.

Masse: 160 x 120 x 100 mm.

## Tool to drive bracelet pins in and out

The tool is designed to maintain watches with metal bracelet in exact position to drive the pins in or out.

Equipped with enough space to enable the ejection of the pins, the pin's position can be adjusted in order to exactly align with the axis of the pin holder.

Rubber protection on top of working surface.

Dimensions: 160 x 120 x 100 mm.

## Útil para sacar y poner las clavijas de pulseras

Útil permite mantener en buena posición los relojes con pulseras metálicas para sacar y poner las clavijas de pulseras.

Con espacio suficiente para evacuar las clavijas, el soporte tiene diversos ajustamientos que permiten centrar todas las ranuras en el eje del porta clavijas.

Protección de caucho en la superficie de trabajo.

Medidas: 160 x 120 x 100 mm.

## MBA Swiss tool

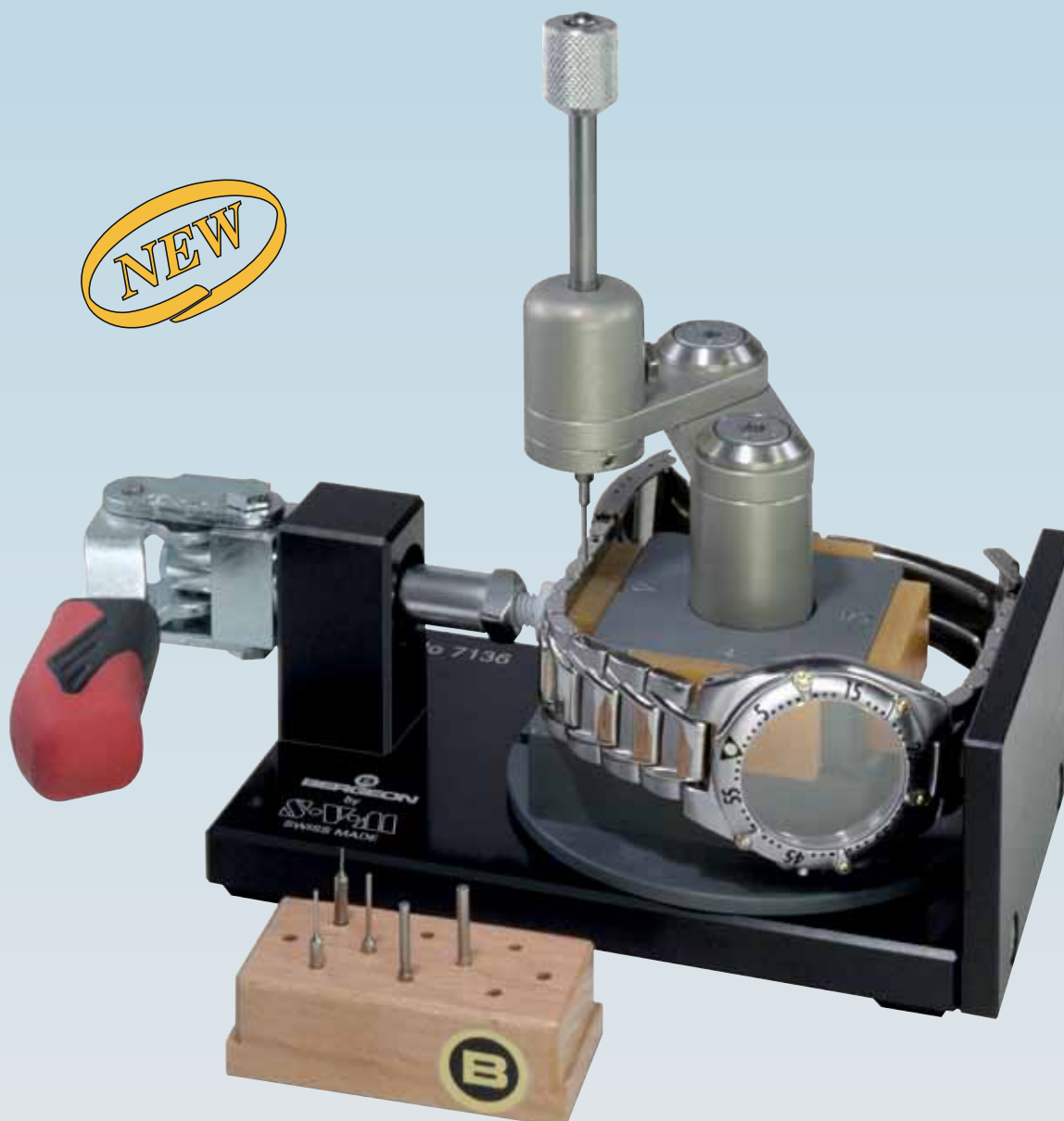

No 7136

500 gr.

Pce Fr.



# BERGEON

Depuis 1791

Tél. + 41 32 933 60 00  
Fax + 41 32 933 60 01

www.bergeon.ch  
info@bergeon.ch

## Dispositif pour perforer les bracelets

Réalisé pour un travail efficace et pratique.

Structure en aluminium.

Forme ergonomique et très maniable.

Permet d'effectuer des trous de toutes formes dans des bracelets en cuir, tissu ou caoutchouc.

Épaisseur: 4.5 mm max.

Largeur: 26 mm max.

Se compose de poinçons, matrices et pions de centrage.

Réglage simple de l'intervalle des trous.

Ø des trous ronds:

1.00, 1.50, 2.00, 2.50 et 3.00 mm

D'autres formes sur demande.

## Armbänderlochapparat

Speziell entwickelt um praktisch und effizient zu Arbeiten.

Struktur aus Aluminium.

In ergonomischer und handlicher Form.

Um Löcher mit verschiedenen Formen in Leder-, Stoff- oder Kautschukarmbänder zu machen.

Dicke: max. 4.5 mm.

Breite: max. 26 mm.

Geliefert mit Punzen, Matrize und Sperrstiften.

Einfache Einstellung vom Abstand den Löchern

Ø von runden Löchern:

1.00, 1.50, 2.00, 2.50 und 3.00 mm.

Andere Formen: auf Anfrage.

## Watch-strap punching device

Designed for a very efficient and practical work.

Aluminium frame.

Ergonomic and easy to use.

Enable to make holes of various shapes in leather, cloth or rubber straps.

Thickness: 4.5 mm max.

Width: 26 mm max.

Contains punches, dies and centring pins.

Easy setting of punching intervals.

Ø of round holes:

1.00, 1.50, 2.00, 2.50 and 3.00 mm.

Other shapes: on demand.

## Dispositivo para perforar las pulseras

Realizado para trabajar de modo eficaz y práctico.

Estructura en aluminio.

Forma ergonómica y de fácil manejo.

Permite efectuar agujeros de todas las formas en pulseras de cuero, tejido o caucho.

Espesor: 4.5 mm max.

Largura: 26 mm max.

Se compone de punzones, matrices y peones de centrado.

Regulación simple del intervalo de los agujeros.

Ø de agujeros redondos:

1.00, 1.50, 2.00, 2.50 y 3.00 mm.

De otras formas bajo petición.



Ecartement réglable - Einstellbare Pitch  
Adjustable Pitch - Ajustable de tono



No 30228

320 gr.

Pce Fr.

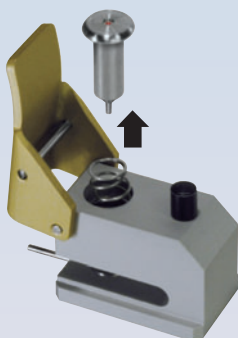

Changement rapide des poinçons et matrices.

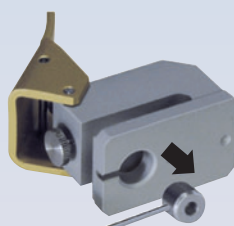

Schnelle änderung der Meißel und Matrizen.

Fast change of the punches and dies.



Cambio rápido de los punzones y matrices.



# BERGEON

Depuis 1791

Tél. + 41 32 933 60 00  
Fax + 41 32 933 60 01

www.bergeon.ch  
info@bergeon.ch

## Extracteur de lunettes

Nouveau concept ergonomique permettant d'extraire plus aisément tous types de lunettes, allant de  $\varnothing$  20 à 58 mm.

Le dispositif offre la possibilité d'intégrer différentes pinces et mors de serrage adaptés à la majorité des formes de lunettes.

### Descriptif:

- Manche en aluminium anodisé.
- Pince universelle en matière synthétique avec 3 jeux de mors amovibles (7820-M01 = 15° - 7820-M02 = 30° - 7820-M03 = 40°).
- 3 pièces d'appui centrales différentes.

## Abheber für Lünetten

Neues ergonomisches Konzept für einfache Entfernung von alle Sorten von Lünetten mit Durchmesser von  $\varnothing$  20 bis 58 mm.

Das Gerät kann mit verschiedene Zangen und Backen ausgerüstet werden für unterschiedliche Lünetten Formen.

### Beschreibung:

- Griff aus Eloxiertem Aluminium.
- Standard Zange aus Kunststoff mit 3 auswechselbare Backensätze (7820-M01 = 15° - 7820-M02 = 30° - 7820-M03 = 40°).
- 3 verschiedene Unterstützung scheiben.

## Extractor for Bezels

New ergonomic concept allowing to extract more easily every kind of bezels, from  $\varnothing$  20 to 58 mm.

The device offers the possibility of integrating various chucks and tightening jaws, adapted to the majority of bezel shapes.

### Description:

- Handle in anodized aluminium.
- Universal chuck in synthetic material with 3 sets of removable jaws (7820-M01 = 15° - 7820-M02 = 30° - 7820-M03 = 40°).
- 3 different central support pieces.

## Extractor de lunetas

Nuevo diseño ergonómico para facilitar la extracción de todo tipo de lunetas entre  $\varnothing$  20 y 58 mm.

El dispositivo ofrece la posibilidad de integrar diferentes pinzas y mordazas de sujeción adaptado a la mayoría de las formas de lunetas.

### Descripción:

- Mango de aluminio anodizado.
- Mordazas sintéticas de plástico con 3 juegos de mordazas desmontables (7820-M01 = 15° - 7820-M02 = 30° - 7820-M03 = 40°).
- 3 piezas centrales de apoyo.



No 7820-10

662 gr.

Pce Fr.

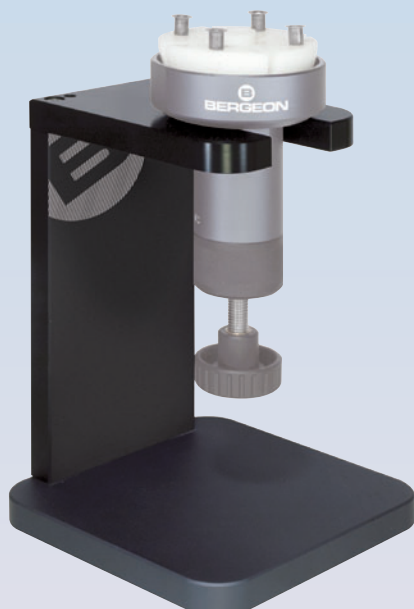

### Support

Apporte une meilleure stabilité à vos opérations d'extraction.

### Halter

Bietet bessere Stabilität beim Lünetten-entfernung.

### Support

Brings a better stability during operations of extraction.

### Soporto

Proporciona una mejor estabilidad para la extracción.

No 7820-001

1.660 kg

Pce Fr.



# BERGEON

Depuis 1791

www.bergeon.ch  
info@bergeon.ch

Tél. + 41 32 933 60 00  
Fax + 41 32 933 60 01



**Extracteur seul**  
**Abheber nur**  
**Extractor only**  
**Extractor sólo**

No 7820-E	517 gr.	Pce Fr.
-----------	---------	---------

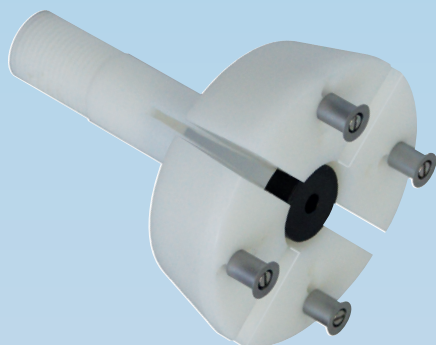

**Pince universelle en matière synthétique**

Avec 3 jeux de mors amovibles  
(7820-M01 = 15° - 7820-M02 = 30° - 7820-M03 = 40°).

**Standard Zange aus Kunststoff**

Mit 3 auswechselbare Backensätze  
(7820-M01 = 15° - 7820-M02 = 30° - 7820-M03 = 40°).

**Universal chuck in synthetic material**

With 3 sets of removable jaws  
(7820-M01 = 15° - 7820-M02 = 30° - 7820-M03 = 40°).

**Mordazas sintéticas de plástico**

Con 3 juegos de mordazas desmontables  
(7820-M01 = 15° - 7820-M02 = 30° - 7820-M03 = 40°).

No 7820-PU	145 gr.	Pce Fr.
------------	---------	---------



**Pince ébauche**  
**Rohwerkzange**  
**Blank chuck**  
**Pinza "ébauches"**

No 7820-PE	150 gr.	Pce Fr.
------------	---------	---------



**Sur demande:** pinces spécifiques.  
**Auf Anfrage:** Kunde spezifische Zange.  
**On request:** blank chuck.  
**Suplemento:** pinzas especiales.



# BERGEON

Depuis 1791

Tél. + 41 32 933 60 00  
Fax + 41 32 933 60 01

www.bergeon.ch  
info@bergeon.ch

## Extracteurs HH pour lunettes tournantes

Poignée ergonomique en alu anodisé avec vis de réglage fin de butée pour éviter d'écraser la lunette.

Nouvelle bague en matière synthétique permettant l'extraction de tous types de lunettes tournantes sans griffer.

### Assortiment de 6 pièces.

Ø intérieur de bague: 30 - 34 - 38 - 42 - 46 - 50 mm.

Ø extérieur de la poignée: 80 mm.

## HH Abheber für drehende Lünetten

Ergonomischer Griff in anodisiertem Aluminium mit Schraube zur Regulierung des Anschlages und Verhinderung dass die Lünette zerdrückt wird.

Neuer Ring in synthetischem Material zur Abhebung aller Arten von drehenden Lünetten ohne sie zu zerkratzen.

### Sortiment von 6 Stück.

Ø inner Rings: 30 - 34 - 38 - 42 - 46 - 50 mm.

Ø äusserlich des Griffs: 80 mm.

## HH extractors for rotating Bezels

Ergonomic handle in anodized aluminum with adjustable screw in end of banking to avoid crushing the Bezel.

New ring in synthetic material allowing the extraction of all kinds of rotating Bezels without scratching.

### Assortment of 6 pieces.

Interior Ø of ring: 30 - 34 - 38 - 42 - 46 - 50 mm.

Ø external of the handle: 80 mm.

## Extractores HH de lunetas

Mango ergonómico en aluminio anodizado con tornillo de regulación para no atropellar la luneta.

Nueva anilla sintética para extracción sin rasguños de todo tipo de lunetas giratorias.

### Surtidos de 6 piezas.

Ø interior de anillo: 30 - 34 - 38 - 42 - 46 - 50 mm.

Ø exterior del punado: 80 mm.



**B**  
**BERGEON**  
Technologies

No 7052

530 gr.

Pce Fr.



Autres dimensions sur demande.  
Andere Dimensionen auf Antrag.  
Other dimensions on request.  
Otras dimensiones sobre demanda.

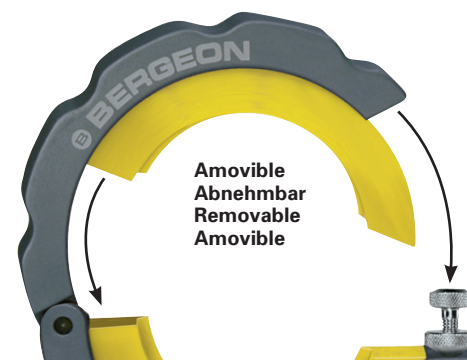
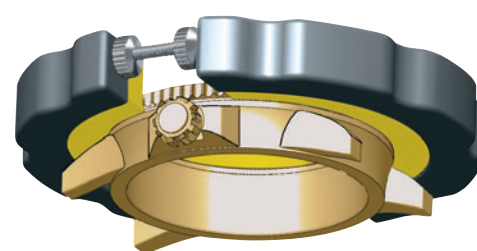

Extracteurs seuls.  
Abheber allein.  
Only extractors.  
Extractores solo.

No 7052-...

Pce Fr.



# BERGEON

Depuis 1791

Tél. + 41 32 933 60 00  
Fax + 41 32 933 60 01

www.bergeon.ch  
info@bergeon.ch

## Paniers de lavage

En aluminium revêtu de TEFLON. Haut niveau de finition des séparations, garantit une bonne circulation des solutions de lavage.

La légèreté des matériaux utilisés favorise un essorage parfait.

Le revêtement préserve les pièces des rayures.

Convient à des installations de lavage.

**Jeu complet:** 1 support, 7 paniers et 1 couvercle.

Eviter l'usage de fluor, de diméthylformamide ainsi que de bases concentrées.

## Waschkörbe

In Aluminium, mit TEFLON Beschichtung.

Hohes Fertigstellungsniveau der Fächer garantiert einen guten Kreislauf der Reinigungslösungen.

Die Leichtigkeit von die verwendete Materialien ergibt ein perfektes Schleudern.

Die Beschichtung schützt die Teile vor Kratzer.

Passt zu Reinigungseinrichtungen.

**Komplett Satz:** 1 Halter, 7 Körbe, 1 Deckel.

Gebrauch von Fluor und Dimethylformamid vermeiden, sowie konzentrierten Lösungen.

## Cleaning baskets

In aluminum with TEFLON coating. High finition level of the separations guarantees a good circulation of the cleaning solutions.

The lightness of the used materials favors a perfect wringing.

The coating protects the parts from scratches.

Suits to cleaning machines.

**Complete set:** 1 support, 7 baskets and 1 lid.

Avoid the use of fluorine, dimethylformamide as well as concentrated bases.

## Cestas de lavado

De aluminio recobrido de TEFLÓN. El alto nivel de acabado de las separaciones garantiza una buena circulación de las soluciones de lavado.

La ligereza de los materiales utilizados favorece un escurrido perfecto.

El recobrido preserva las piezas de los rasguños.

Conviene instalaciones de lavado.

**Juego completo:** 1 soporte, 7 cestas y 1 tapa.

Evitar el uso de flúor, de dimethylformamide así como de bases concentradas.



No 7043

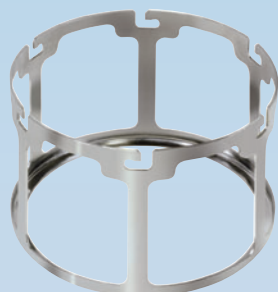

7043-10

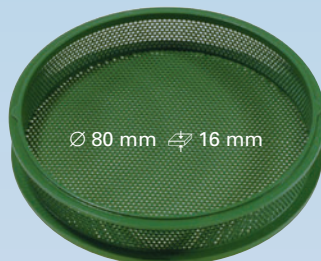

7043-06

7043-02

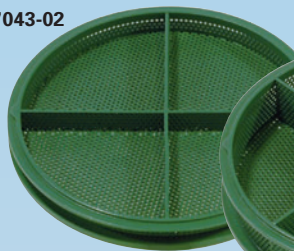

7043-07

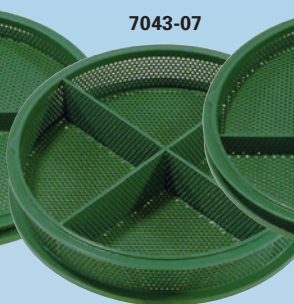

7043-01

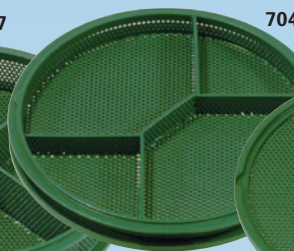

7043-11

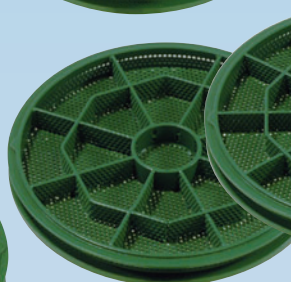

7043-04

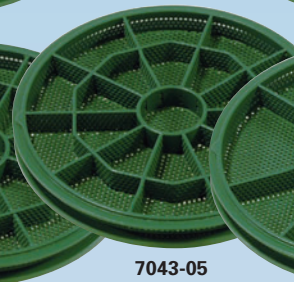

7043-05

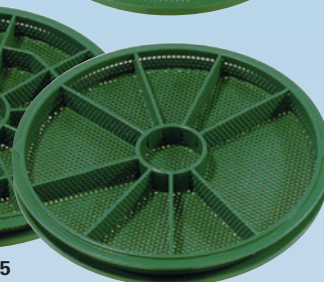

7043-03



No	gr.	Pce Fr. / 100	Pce Fr. / 10	Pce Fr.
7043	197			

## Contenu

No	gr.	Pce Fr. / 100	Pce Fr. / 10	Pce Fr.
7043-01	17.2			
7043-02	17.5			
7043-03	19.5			
7043-04	20.5			
7043-05	20.7			

## Inhalt

## Contents

No	gr.	Pce Fr. / 100	Pce Fr. / 10	Pce Fr.
7043-06	18			
7043-07	21			
7043-10	31.5			
7043-11	13			

## Contenido

## Hors assortiment

Ø 24 mm  $\varnothing$  14 mm

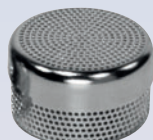

7043-09

## Nicht im Sortiment

Ø 18 mm  $\varnothing$  13 mm

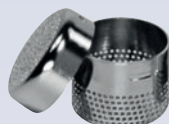

7043-08

## Not in assortment

Petits paniers à baïonnette en acier inox.

Kleine Verschlusskörbe aus Edelstahl.

Small stainless steel baskets with bayonet closing.

Pequeñas cestas en "baïonnette" de acero inoxidable.

## No en el surtido

No	gr.	Pce Fr. / 100	Pce Fr. / 10	Pce Fr.
7043-08	3.65			
7043-09	5.95			





**Paniers de lavage**

En acier inox.  
Haut niveau de finition des séparations, garantit une bonne circulation des solutions de lavage.  
La légèreté des matériaux utilisés favorise un essorage parfait.  
Convient à des installations de lavage.  
**Jeu complet:** 1 support, 7 paniers et 1 couvercle.  
Eviter l'usage de fluor, de diméthylformamide ainsi que de bases concentrées.

**Waschkörbe**

In Edelstahl.  
Hohes Fertigstellungsniveau der Fächer garantiert einen guten Kreislauf der Reinigungslösungen.  
Die Leichtigkeit von die verwendete Materialien ergibt ein perfektes Schleudern.  
Passt zu Reinigungseinrichtungen.  
**Komplett Satz:** 1 Halter, 7 Körbe, 1 Deckel.  
Gebrauch von Fluor und Dimethylformamid vermeiden, sowie konzentrierten Lösungen.

**Cleaning baskets**

In stainless steel.  
High finition level of the separations guarantees a good circulation of the cleaning solutions.  
The lightness of the used materials favors a perfect wringing.  
Suits to cleaning machines.  
**Complete set:** 1 support, 7 baskets and 1 lid.  
Avoid the use of fluorine, dimethylformamide as well as concentrated bases.

**Cestas de lavado**

De acero inoxidable.  
El alto nivel de acabado de las separaciones garantiza una buena circulación de las soluciones de lavado.  
La ligereza de los materiales utilizados favorece un escurrido perfecto.  
Convienen instalaciones de lavado.  
**Juego completo:** 1 soporte, 7 cestas y 1 tapa.  
Evitar el uso de flúor, de dimetilformamida así como de bases concentradas.



No 7043-I



7043-I-02



7043-I-07

7043-I-01



7043-I-11



7043-I-06



7043-I-04



7043-I-05



7043-I-03

No	gr.	Pce Fr. / 100	Pce Fr. / 10	Pce Fr.
7043-I	197			



**Contenu**

**Inhalt**

No	gr.	Pce Fr. / 100	Pce Fr. / 10	Pce Fr.
7043-I-01	17.2			
7043-I-02	17.5			
7043-I-03	19.5			
7043-I-04	20.5			
7043-I-05	20.7			

**Contents**

**Contenido**

No	gr.	Pce Fr. / 100	Pce Fr. / 10	Pce Fr.
7043-I-06	18			
7043-I-07	21			
7043-I-10	31.5			
7043-I-11	13			

**Hors assortiment**

**Nicht im Sortiment**

Ø 24 mm x 14 mm

Ø 18 mm x 13 mm

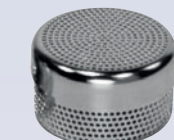

7043-09

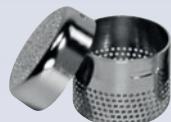

7043-08

**Not in assortment**

**No en el surtido**

Petits paniers à baïonnette en acier inox.  
Kleine Verschlusskörbe aus Edelstahl.  
Small stainless steel baskets with bayonet closing.  
Pequeñas cestas en "baïonnette" de acero inoxidable.

No	gr.	Pce Fr. / 100	Pce Fr. / 10	Pce Fr.
7043-08	3.65			
7043-09	5.95			



# BERGEON

Depuis 1791

Tél. + 41 32 933 60 00  
Fax + 41 32 933 60 01

www.bergeon.ch  
info@bergeon.ch

## Machine pour le remontage des montres automatiques

### Duotest

Nouvelle machine conçue spécialement pour le SAV.

La Duotest fonctionne en mode programmable hebdomadaire, en mode minuterie et en marche continue.

#### Caractéristiques techniques:

- Capacité: 48 têtes de montre ou 48 montres avec bracelet.
- Fréquence de rotation: 1 ou 4 cycles/min.
- Porte-boîtes pour conditionnement avec couvercle 130 x 130 mm avec 4 compartiments.
- Encombrement: 56 x 60 x 33 cm.
- Alimentation: 230 ou 115 V (tableau de commande: 24 V).

## Maschine zum Aufziehen der automatischen Uhren

### Duotest

Neue Maschine eignet sich hervorragend für das Service-werkstätte.

DUOTEST funktioniert in wöchentlichen programmier-bar Modus, Timer Modus und andauernden Lauf Modus.

#### Technische Daten:

- Kapazität: 48 Uhren mit oder ohne Band.
- Drehfrequenz: 1 oder 4 Zyklen/Min.
- Schachteln Halter mit Deckel: 130 x 130 mm mit 4 Fächern
- Abmessungen: 56 x 60 x 33 cm.
- Strom: 230 oder 115 V (Bedienerfeld: 24V).

## Machine for winding automatic watches

### Duotest

New machine designed specifically for the After Sales Service.

DUOTEST operates in program-mable weekly mode timer and continues mode.

#### Technical data:

- Capacity: 48 watch cases only or 48 watches with strap.
- Rotation frequency: 1 or 4 cycles/min.
- Carrier boxes for packing with lid 130 x 130 mm with 4 compartments.
- Size: 56 x 60 x 33 cm.
- Power: 230 or 115 V (control panel: 24 V).

## Máquina para el remontaje de los relojes automáticos

### Duotest

Nueva máquina diseñada específicamente para el servicio técnico.

DUOTEST opera en el modo de temporizador semanal programa-ble y continúa la operación.

#### Características técnicas:

- Capacidad: 48 cajas de reloj o 48 relojes con correa.
- Frecuencia de rotación: 1 o 4 ciclos/min.
- Puerta de cajas para el embalaje con tapa 130 x 130 mm con 4 compartimentos.
- Dimensiones: 56 x 60 x 33 cm.
- Potencia: 230 o 115 V (panel de control: 24 V).

# ASTUTO

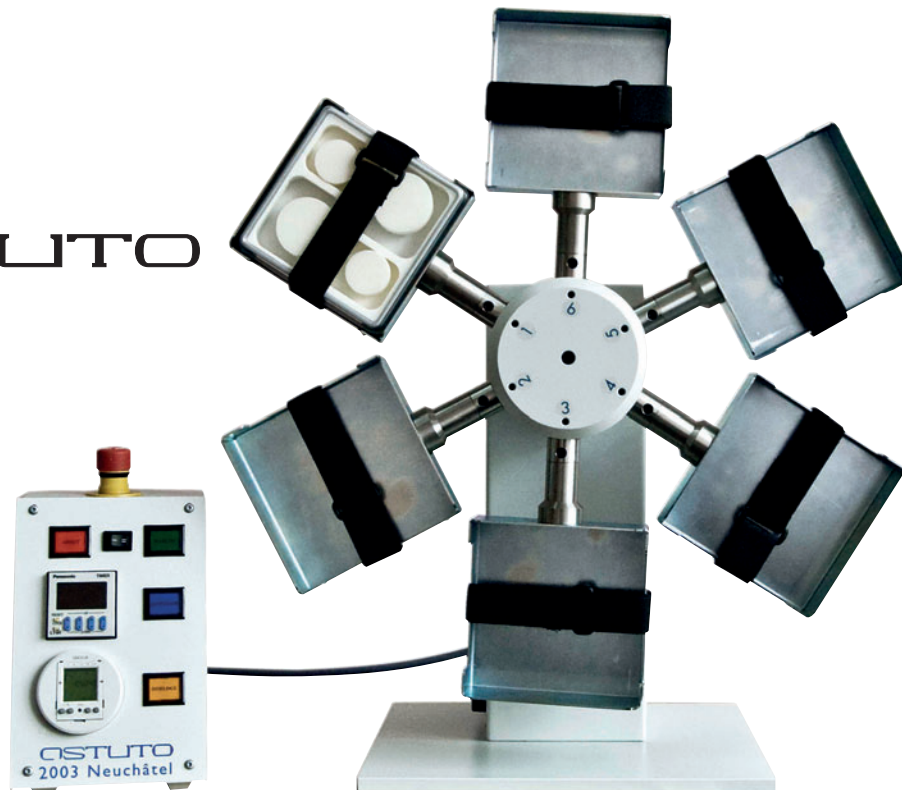

No 7163-115	37 Kg	Pce Fr.
No 7163-230	37 Kg	Pce Fr.

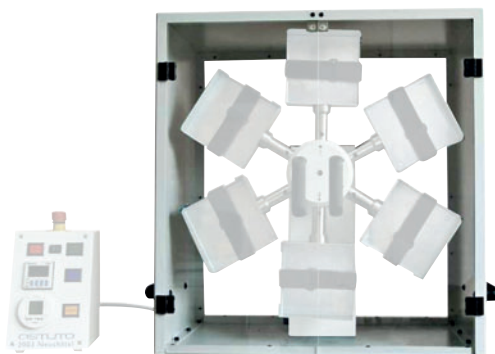

Caisson de protection  
Schutzkasten mit Glastüren  
Protective box with glass doors  
Caja de protección con puertas de cristal

No 7163-48	18 Kg	Pce Fr.
------------	-------	---------



Tél. + 41 32 933 60 00  
Fax + 41 32 933 60 01

# BERGEON

Depuis 1791

www.bergeon.ch  
info@bergeon.ch

## Nouvel appareil à contrôler l'étanchéité des boîtes de montres

A pression d'air.

Cylindre amovible pour vidanger. Raccord pour compresseur ou pompe. Mise en pression manuelle de 0 à 10 atm.

Crochet pour montre en matière synthétique.

**Capacité de contrôle: 0-11 atm. (sécurité à 11 atm.).**

Bâti en fonte d'aluminium.

Robuste, très stable.

Cylindre Ø int.: 70 mm.

Capacité de contenance: 2 montres.

Dimensions: 275 x 167.5 x 390 mm.

## Neu Apparat zur Kontrolle der Wasserdichtigkeit von Uhrgehäusen

Mit Luftdruck.

Zylinder abnehmbar zur Entleerung. Anschluss für Kompressor oder Pumpe. Druckregulierung von 0-10 Atü.

Haken für Uhr aus synthetischem Material.

**Kontrollkapazität 0-11 Atü (Sicherheit bei 11 Atü).**

Gestell aus Aluminiumguss.

Robust und sehr stabil.

Zylinder Innen Ø: 70 mm.

Kapazität: 2 Uhren.

Dimensionen: 275 x 167.5 x 390 mm.

## New apparatus for testing the water resistance of watch cases

Air pressure system.

Removable cylinder for draining. Connector for compressor or pump.

Manual pressure from 0 to 10 atm.

Hook for synthetic matter watch.

**Control Capacity : 0-11 atm. (security at 11 atm).**

Built in aluminium cast iron.

Strong, very stable.

Cylinder Ø: 70mm.

Volume capacity: 2 watches.

Dimensions: 275 x 167.5 x 390 mm.

## Nuevo aparato para controlar la impermeabilidad de las cajas de relojes

Con presión de aire.

Cilindro amovible para desaguar. Conectado para compresor o bomba. Puesta en presión manual de 0 a 10 atm.

Gancho para reloj en materia sintética.

**Capacidad de control: 0-11atm. Seguridad a 11 atm.**

Bastidor de fundición de aluminio.

Robusto, muy estable.

Cilindro Ø int.: 70mm.

Capacidad: 2 relojes.

Dimensiones: 275 x 167.5 x 390 mm.

## BERGEON No 5555/10

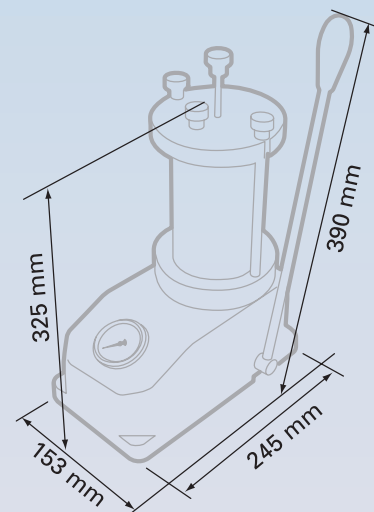

No 5555/10

7.100 kg

Pce Fr.



**Cylindre amovible pour vidanger**  
**Zylinder abnehmbar zur Entleerung**  
**Removable cylinder for draining**  
**Cilindro amovible para desaguar**



No 5555/10-TP

545 gr.

Pce Fr.

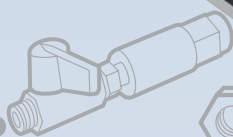
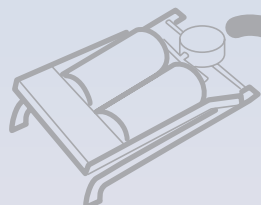
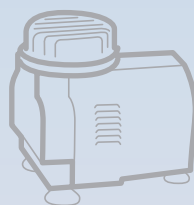
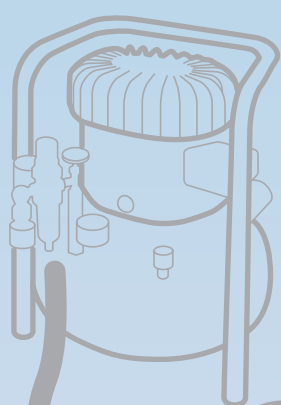

G 1/4





**BERGEON**

Depuis 1791

Tél. + 41 32 933 60 00  
Fax + 41 32 933 60 01

www.bergeon.ch  
info@bergeon.ch

# DUNE



Swiss made

by Bergeon

No 7870-D	127 Kg	Pce Fr.
-----------	--------	---------

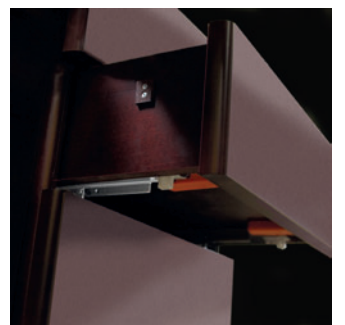



## WAVE



by Bergeon

No 7870-W

120 Kg

Pce Fr.





# BERGEON

Depuis 1791

Tél. + 41 32 933 60 00  
Fax + 41 32 933 60 01

www.bergeon.ch  
info@bergeon.ch

## Nouvelle génération d'établi pour horloger

Ergonomique, de conception nouvelle.

Il place l'horloger dans son environnement de travail en prenant en compte des exigences ergonomiques et esthétiques. Ce résultat est le fruit d'une intense collaboration avec un large panel d'horlogers, de manufactures et d'écoles. Son plateau à deux niveaux qui fait l'objet d'un dépôt de modèle.

Aux normes de sécurité SUVA.

## Neue Werkbankgeneration für Uhrmacher

Ein neues Konzept von ergonomischen Uhrmacherwerkstisch.

Das Ergebnis entstand Dank der intensiven Zusammenarbeit mit unseren Partnern und andererseits Dank Umfragen bei Uhrmachern, Manufakturen sowie Schulen. Dies aufgrund der Gestaltung der Arbeitsfläche die aus zwei Ebenen besteht. Die Patentierung dafür wurde bereits angemeldet.

SUVA-Sicherheitsnormen.

## New generation of work bench for watchmaker

Ergonomic, of new design.

He places the clock and watch maker in his work environment by taking into account ergonomic and esthetic requirements. This result is the fruit of an intense collaboration with a broad panel of clock and watch makers, manufactures and schools. Its plate on two levels which is the object of a deposit of model.

Safety standards SUVA.

## Nueva generación de banco para relojero

Ergonomico de nueva concepción.

Este ultimo situa al relojero en su ambiente de trabajo teniendo en cuenta de las exigencias ergonomicas y esteticas. Este resultado es el fruto de una intensa colaboración tras haber sido previamente sensibilizados por muchos relojeros, manufacturas y escuelas. Su sobremesa a dos niveles que es objeto de un depósito de modelo.

A normas de seguridad SUVA.

## DUNE

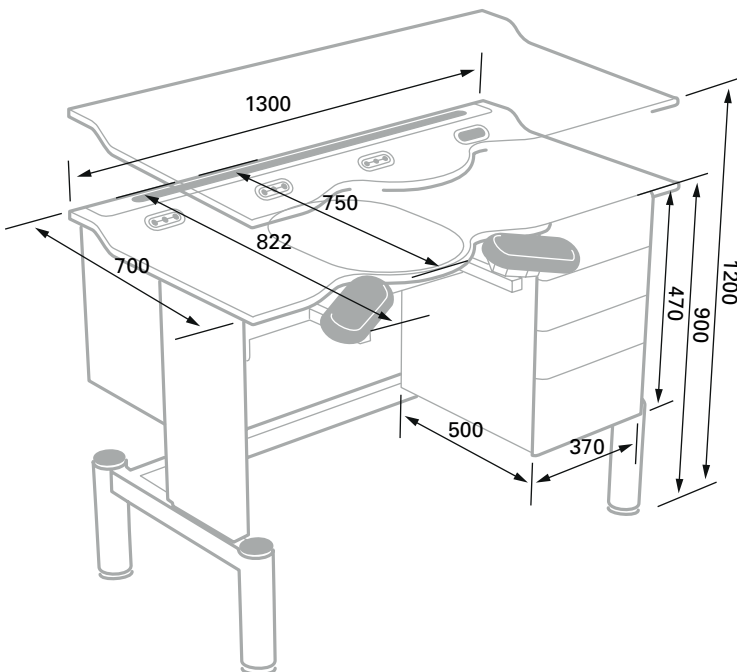

## WAVE

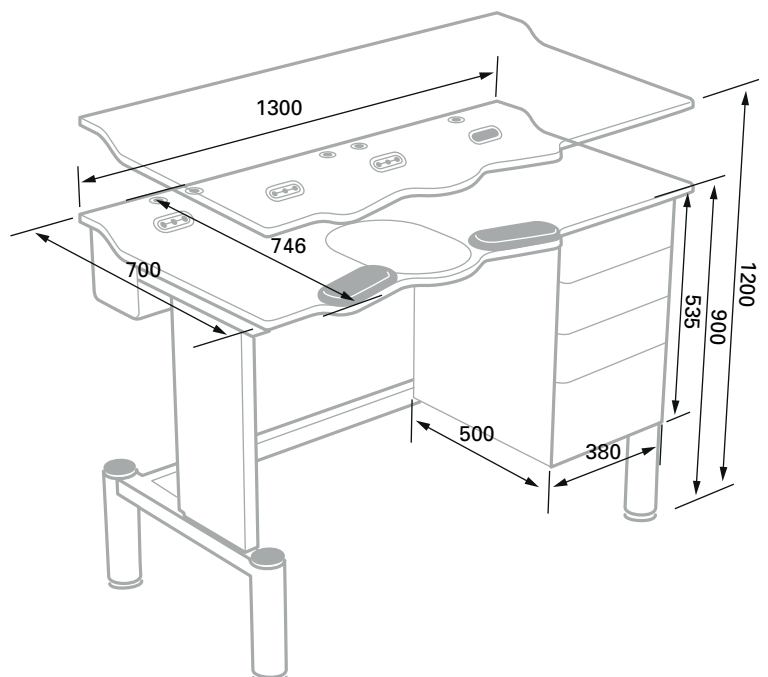



# BERGEON

Depuis 1791

Tél. + 41 32 933 60 00  
Fax + 41 32 933 60 01

www.bergeon.ch  
info@bergeon.ch

## Etabli d'horloger modulaire

Etabli très stable donnant un confort de travail inégalable qu'elle que soit la grandeur de la personne. Puissance d'élevation 250 kg. Surface du plateau: 140 x 70 cm.

## Modulierbarer Werkstisch für Uhrmacher

Dieser sehr stabile Werkstisch bietet ein komfortables Arbeiten unabhängig der Grösse der Person. Hebeleistung 250 kg. Dimensionen Arbeitsfläche: 140 x 70 cm.

## Flexible work bench for watchmakers

High stability work bench allowing comfortable working whatever the size of the operator. 250 kg lifting power. Bench top surface 140 x 70 cm.

## Mesa de trabajo modulaire para relojeros

Mesa de trabajo muy estable garantizando un ambiente de trabajo agradable independientemente del tamaño de la persona. Potencia de elevación 250 kg. Superficie de trabajo 140 x 70 cm.



 SWISS MADE

Pied électrique réglable  
Tischbein elektrisch verstellbar  
Electric adjustable table leg  
Pata de mesa ajustable eléctricamente

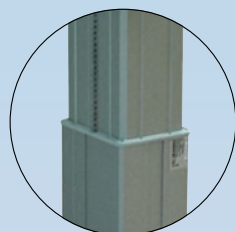

Plateau en stratifié vert avec accoudoirs en hêtre  
Arbeitsplatte in grünes Laminat mit Armlehnen in Buche  
Bench top in beech laminated green with armrests in beech wood  
Superficie de trabajo en laminada verde con apoyabrazos en madera de haya

No 7219-S	115 Kg	Pce Fr.
-----------	--------	---------

Plateau en stratifié vert avec accoudoirs en simili cuir  
Arbeitsplatte in grünes Laminat mit Armlehnen in Kunstleder  
Bench top in beech laminated green with armrests in leatherette  
Superficie de trabajo en laminada verde con apoyabrazos en cuero artificial

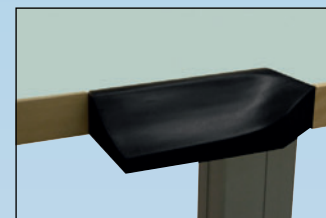

No 7219-S-SC	115 Kg	Pce Fr.
--------------	--------	---------

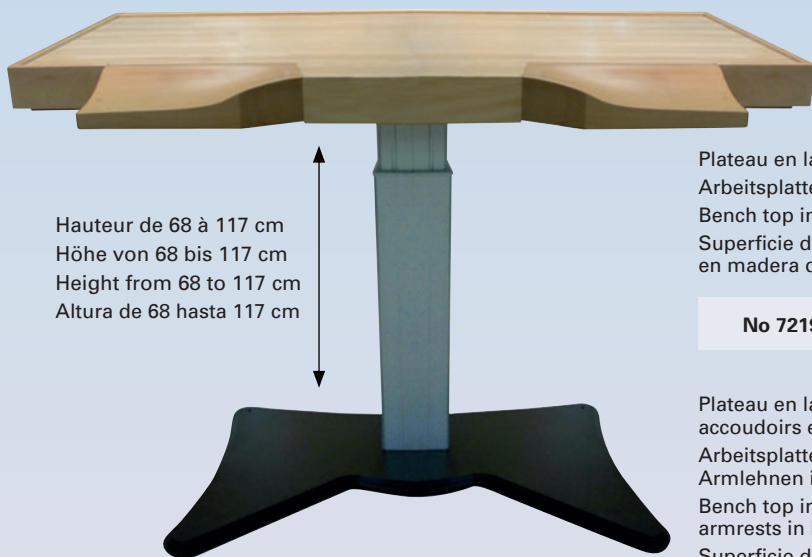

Hauteur de 68 à 117 cm  
Höhe von 68 bis 117 cm  
Height from 68 to 117 cm  
Altura de 68 hasta 117 cm

Plateau en lamellé-collé avec accoudoirs en hêtre  
Arbeitsplatte in Buche mit Armlehnen in Buche  
Bench top in beech wood with armrests in beech wood  
Superficie de trabajo en madera de haya con apoyabrazos en madera de haya

No 7219-H	125 Kg	Pce Fr.
-----------	--------	---------

Plateau en lamellé-collé avec accoudoirs en simili cuir  
Arbeitsplatte in Buche mit Armlehnen in Kunstleder  
Bench top in beech wood with armrests in leatherette  
Superficie de trabajo en madera de haya con apoyabrazos en cuero artificial



No 7219-H-SC	125 Kg	Pce Fr.
--------------	--------	---------







# BERGEON

Depuis 1791

Tél. + 41 32 933 60 00  
Fax + 41 32 933 60 01

www.bergeon.ch  
info@bergeon.ch

## Flux laminaire vertical

Classe ISO 5 pour pose sur établi ou plan de travail

comprenant :

Eclairage fluorescent incorporé

Filtre primaire G3

Filtre absolu H14

Régulation automatique du flux à débit constant contrôlé par micro-processeur

Tableau de commandes incluant :  
3 niveaux de débit réglable  
Commande éclairage

Ecran LCD avec indication de la vitesse du flux, le débit, la pression, voyant alarme ventilateur et alarme colmatage filtre H14

Caisson en aluminium peint (couleur gris) posé sur des parois en verre Securit

Niveau sonore : 55dba

Puissance absorbée 1 kW

Livré avec le certificat de conformité à la norme ISO 14644 et certificat de garantie.

## Vertikale Laminare Luftströmung

Klasse ISO 5 zum aufstellen auf einem Werkstisch oder Arbeitsplatz

Eingebaute Beleuchtung

Primärfilter: G3

Hauptfilter: H14

Automatische Regulierung und uniformen Luftstrom, Mikroprozessor gesteuert.

Bedienungsfeld mit LCD  
Anzeige von Luftgeschwindigkeit und Downflow rate

Lichtsteuerung

3 Luftstrom Stufen

Kontrollanzeige Ventilator und Filter

Aluminiumgehäuse (Farbe grau) und Securit Glaswände

Lärmpegel : max. 55db

Leistungsaufnahme 1 kW

Geliefert mit Zertifikat ISO 14644 und Garantiezertifikat.

## Vertical Laminar Flow

Class ISO 5 to be put on a workbench or workplace

Built-in lightning

Primary filter G3

Main Filter H14

Very regular flow, automatic controlled by Microprocessor

Control panel with LCD

Indication of flow speed and downflow rate

3 flowrates

lightning control

Control leds for ventilator and filter

Aluminum housing (gray color) and Securit glass walls

Noise level: max 55db

Power absorbed 1kW

Delivered with SIO certificate 14644 and certificate of guarantee.

## Cabinas de flujo laminar vertical

Clase ISO 5 para sobremesa incluido :

Iluminación interna fluorescente

Filtro primario G3

Filtro absoluto H14

Regulación automática del flujo y regulación constante del aire mediante microprocesador

Panel de monitorización :

3 regimenes de trabajo de la cabina Interruptor iluminación

Control digital con pantalla LCD indicación de la velocidad del flujo, caudal, presión, alarma ventilador y saturación filtro H14

Mueble en aluminio lacado (color gris) puesto sobre paredes en vidrio Securit

Nivel de ruido : 55 dB

Potencia 1 kW

Suministrado con certificación de conformidad de la norma ISO 14644 y certificado de garantía.



Tableau de commande  
Bedienungsfeld  
Control panel  
Panel de monitorización



No 7862-F      260 g      Pce Fr.

Filtre primaire (G3)  
Primärfilter  
Primary filter  
Filtro primario

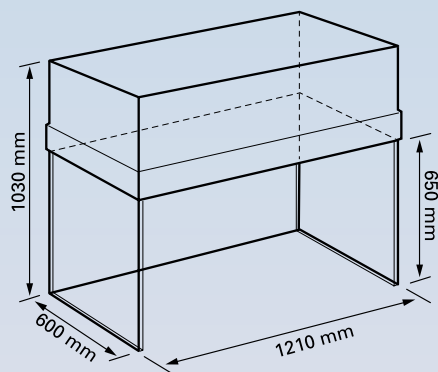
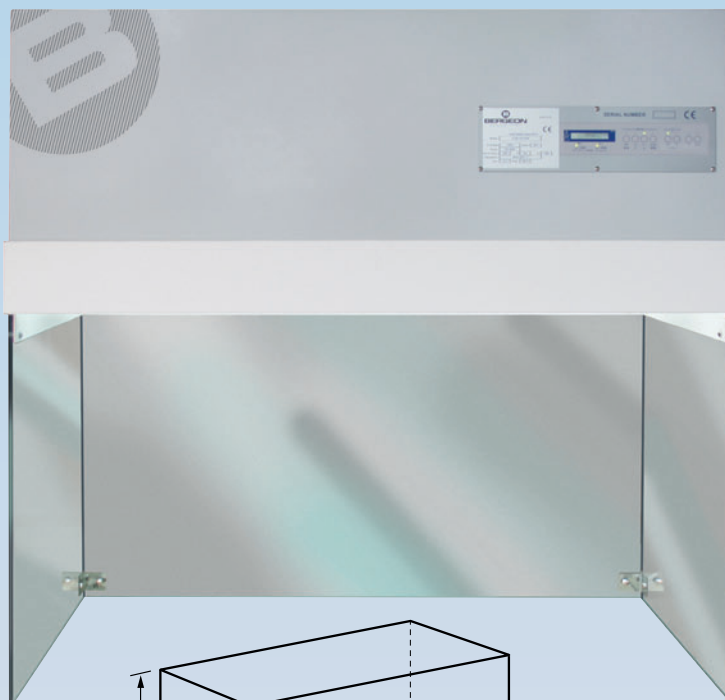
No 7862-FL612-230      80 Kg      Pce Fr.

No 7862-FL609-230      60 Kg      Pce Fr.

Autre dimension  
Andere Dimension  
Other sizes  
Otra dimensión

925 x 600 mm

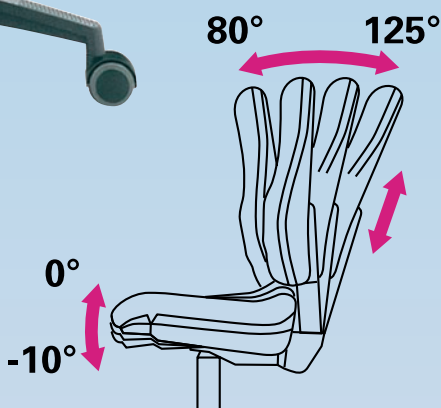

### Chaise ergonomique d'horloger

Siège et dossier pivotants en bois, rembourrage en tissu.  
**Piètement à 5 branches en polyamide noire avec roulettes doubles autobloquantes pour sol dur.**  
 Hauteur, réglable de 43 à 59 cm par système à gaz au moyen d'un levier. Dossier réglable séparément.

### Ergonomischem Stuhl für Uhrmacher

Drehbarer Sitz und Rückenlehne aus Holz, Polsterung aus Stoff.  
**Mit 5 armigen Füßen aus Schwarzem Polyamid mit doppel Rollen selbst-blozierend für harte Böden.**  
 Regulierbare Höhe von 43 bis 59 cm durch einem Gas-System mit einem Hebel. Rückenlehne separat regulierbar.

### Ergonomic chair to watchmaker

Rotative seat and back made of wood, upholstery cloth.  
**On 5 branch pedestal in black synthetic material with self-tightening double wheels for hard floor.**  
 Height adjustable from 43 to 59 cm by gas system with the help of a lever. Back adjustable separately.

### Silla ergonómica de relojero

Asiento giratorio y respaldo de madera y tela.  
**Base con 5 ramas en materia sintética negra con doble ruedas autoblocantes para suelo duro.**  
 Altura regulable de 43 a 59 cm por sistema de gas, con palanca. Respaldo ajustable separadamente.

No 7172

12 kg

Pce Fr./10

Pce Fr.

### Chaise ergonomique de bijoutier

Coque extérieure en polyamide noir. Garniture en matière synthétique (polyuréthane). **Piètement à 5 branches en polyamide noire.**  
 Hauteur, réglable de 40 à 56 cm par système à gaz au moyen d'un levier. Dossier réglable séparément. Siège et dossier pivotants, rembourrés.  
**Modèle antistatique sur demande.**

### Ergonomischem Stuhl für Juwelier

Beschichtung aus Schwarzem Polyamid. Verzierung aus Synthetischem Material (Polyurethan).  
**Mit 5 armigen Füßen aus Schwarzem Polyamid.**  
 Regulierbare Höhe von 40 bis 56 cm durch einem Gas-System mit einem Hebel. Rückenlehne separat regulierbar. Drehbarer Sitz und Rückenlehne, gepolstert. **Antistatisches Modell auf Anfrage.**

### Ergonomic chair to jeweler

Black polyamid outer shell. Plastic trim (polyurethane).  
**On 5 branch pedestal in black synthetic material.**  
 Height adjustable from 40 to 56 cm by gas system with the help of a lever. Back adjustable separately. rotative seat and back.  
**Anti-static model on request.**

### Silla ergonómica de joyero

Cubierta exterior negra poliamido. Asiento y respaldo de poliuretano.  
**Base con 5 ramas en materia sintética negra.**  
 Altura regulable de 40 a 56 cm por sistema de gas, con palanca. Respaldo ajustable separadamente. Asiento y respaldo rellenos.  
**Modelo estático sobre pedido.**



No 7173

14.7 Kg

Pce Fr./10

Pce Fr.



# BERGEON

Depuis 1791

Tél. + 41 32 933 60 00  
Fax + 41 32 933 60 01

www.bergeon.ch  
info@bergeon.ch

## Polisseuse nouvelle génération Vario

Pour utilisation droitier et gaucher.

### 1 poste de travail.

Fabrication suisse.  
Complètement carénée en tôle d'acier, recouverte de vernis plastifié très résistant.  
Nombre de tours réglable par **variateur électronique**.  
Aspiration et d'éclairage incorporé indépendant.  
Protection pivotante en plexi.  
Volet latéral mobile.  
Bac de récupération en acier inox.  
Fixation des accessoires **sur axe conique**.

### Livrée avec:

- 1 porte meule conique No 6880-HD
- 1 filtre jetable No 6699-D
- 1 tube néon No 6666-E
- 1 clef à fourche (17 mm)

### Caractéristiques techniques:

Moteur **couple constant** de 0.5 CV  
Courant: 1.7 A  
Conforme aux **normes CE**.  
Ø de meules **maxi 200 mm**.  
Accessoires: ☎ 5071 C.

## Vario Poliergeräte neue Generation

Für Benutzung rechtshändig und Linkshänder.

### 1 Arbeitsplatz.

Schweizer Fabrikat.  
Komplett mit Stahlblech verkleidet, Anstrich mit hoch widerstandsfähigem plastifiziertem Schutzlack.  
Anzahl der Umdrehungen kann über **elektronischen Drehzahlregler** gesteuert werden. Getrennt eingebauter Absauger und Beleuchtung.  
Drehbare Schutzvorrichtung aus Plexiglas. Seitlicher beweglicher Staubabfänger. Auffangwanne aus nichtrostendem Stahl. Befestigung der Zusatzteile auf **konischer Achse**.

### Lieferung mit:

- 1 konischen Verlängerungsstück Nr. 6880-HD
- 1 Wegwerffilter Nr. 6699-D
- 1 Neon-Röhre Nr. 6666-E
- 1 Gabelschlüssel

### Technische Eigenschaften:

Motor mit **konstantem Drehmoment** von 0,5 CV  
Strom: 1.7 A  
Gemäß **CE-Richtlinie**.  
**Scheiben Ø max. 200 mm**.  
Zubehörteile: ☎ 5071 C.

## New generation compact polishing unit Vario

For use right- and left-handed person

### 1 work place.

Made in Switzerland.  
Completely housed in steel plate, with very resistant plasticized coating.  
Machine speed in rpm is controlled by an **electronic variator**.  
Independent dust collection and incorporated lighting.  
Plexiglass pivot-mounted guard.  
Sliding side plate.  
Stainless steel collection case.  
Accessories attached on **conical arbor**.

### Supplied with:

- 1 conical arbor No 6880-HD
- 1 disposable dust filter No 6699-D
- 1 neon tube No 6666-E
- 1 open-end wrench (17 mm)

### Technical characteristics:

**Constant torque** motor, 0.5 hp  
Current: 1.7 A  
Complies with **CE standard**.  
**Max. arbor Ø: 200 mm**.  
Accessories: ☎ 5071 C.

## Pulidora nueva generación Vario

Para utilización diestro y zurdo.

### 1 puesto de trabajo.

Fabricación suiza.  
Completamente carenada en chapa de acero, recubierta de barniz plastificado muy resistente.  
Número de vueltas regulable por **variador electrónico**.  
Aspiración y luz incorporada independiente.  
Protección pivotante de plexiglás.  
Postigo lateral móvil. Bandeja de recuperación de acero inoxidable.  
Fijación de los accesorios en un **eje cónico**.

### Se entrega con:

- 1 porta-muela cónico No 6880-HD
- 1 filtro desechable No 6699-D
- 1 tubo de neón No 6666-E
- 1 llave de horquilla (17 mm)

### Características técnicas:

Motor par **constante** de 0,5 CV  
Corriente: 1.7 A  
Conforme a la **norma CE**.  
Ø de muelas **máximo 200 mm**.  
Accesorios: ☎ 5071 C.



6890-G-220







 SWISS MADE



6890-D-220

Combinaison pour 2 postes - Kombination für 2 Posten  
Combination for 2 stations - Combinación para 2 puestos.

No	 Kg	rpm			L/P/H mm.		
6890-G-220	26	0 / 3600	410 m <sup>3</sup> /h	4W	500 x 430 x 390	220 V - 50 Hz - 0,2/0,3 kW	Pce Fr.
6890-D-220	26	0 / 3600	410 m <sup>3</sup> /h	4W	500 x 430 x 390	220 V - 50 Hz - 0,2/0,3 kW	Pce Fr.

Tél. + 41 32 933 60 00  
Fax + 41 32 933 60 01

**B**  
**BERGEON**  
D e p u i s 1 7 9 1

www.bergeon.ch  
info@bergeon.ch

## E-max Evolution

### Micromoteurs à grande vitesse de rotation.

1'000/40'000 t/min. **Sans charbon.**

Excellent rapport compacité / puissance de la pièce à main. Idéal pour travaux de précisions tels que polissage, gravure, sertissage etc.

Grands nombre d'accessoires. Possibilité de commander alternativement 2 pièces à main. Changement rapide de l'outil. Qualité de finition et longévité exceptionnelle.

**Accessoires:** nous consulter pour une documentation complète.

### Mikromotor mit hoher Dreh-Geschwindigkeit.

1'000/40'000 U/m. **Ohne Kohl.**

Vorzügliche Kompaktheit / Leistung des Handstücks.

Ideal für die Präzisions Arbeit wie Polieren, Gravieren, Einfassen, u.s.w. Grosse Zubehör Auswahl.

Wechselweise 2 Handstücke bestellbar.

Rascher Wechsel des Werkzeugs. Feinbearbeitung und Langleistung einmalig.

**Zubehör:** Für eine komplette Dokumentation, wenden Sie sich bitte an uns.

### Micromotor with high speed rotation.

1'000/40'000 r.p.m. **Brushless.**

Excellent compactness/ hand-piece power ratio.

It's an ideal machine for any precision works such as polishing, engraving, stone-setting, etc.

Wide selection of accessories.

Option to operate two hand-pieces alternatively.

Quick change of tools.

Exceptional quality of finishing and longevity.

**Accessories:** For a complete documentation, please contact us.

### Micromotor con alta velocidad de rotación.

1'000/40'000 r.p.m. **Sin carbón.**

Excelente relación compacidad / potencia de la pieza de mano.

Ideal para trabajos de precisión como el pulimento, grabado y engaste, etc.

Gran surtido de accesorios.

Possibilidad de pilotar alternativamente 2 piezas de mano.

Cambio rápido de herramienta. Calidad excepcional.

**Accesorios:** consultarnos para recibir una documentación completa.



1'000 ~ 40'000 t/min  
4.3 cN·m

### Caractéristiques techniques

#### Boîtier de commande - Steuergerät - Controller - Mando de control

Régulation de la vitesse - Drehzahlregulierung - Speed regulation - Regulación de la velocidad

Alimentation - Netzanschluss - Main supply - Voltage

Poids - Gewicht - Weight - Peso

#### Moteur - Motor -

Pince de serrage - Spannzange - Collet - Pinza de sujeción

Poids total - Total Gewicht - Total weight - Peso totale

Puissance continue - Dauerleistung - Permanent output - Potencia continua

### Technical data

1.000 - 40.000 rpm

120 ou - oder - or 230 VAC, 50/60 Hz

2.3 kg

Ø 2.35 ou - oder - or Ø 3 mm

302 g

73 W

### Características técnicas

No 7162-115	2.6 kg	Pce Fr./10	Pce Fr.
-------------	--------	------------	---------

No 7162-230	2.6 kg	Pce Fr./10	Pce Fr.
-------------	--------	------------	---------

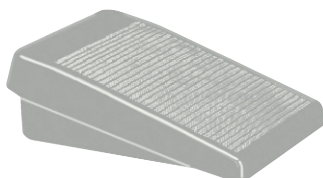

**Pédale de contrôle.** Variation continue de la vitesse de rotation.

**Kontrollpedal.** Fortlaufende Variation der Drehgeschwindigkeit.

**Foot switch.** Continuous variation of rotation speed.

**Pedal de control.** Variación continua de la velocidad de rotación.

No 7162-8106	746 gr.	Pce Fr.
--------------	---------	---------

Tél. + 41 32 933 60 00  
Fax + 41 32 933 60 01

**B**  
**BERGEON**  
D e p u i s 1 7 9 1

www.bergeon.ch  
info@bergeon.ch



### Porte-pièce extensible et réversible

Pour calibres 3 3/4''' - 11''' . Nickelé et sablé.

### Dehn- und umkehrbarer Werkhalter

Für Kaliber 3 3/4''' - 11''' . Vernickelt und sandgestrahlt.

### Extensible and reversible movement holder

For calibres 3 3/4''' - 11''' . Nickelled and sanded.

### Porta-máquina extensible y reversible

Para calibres 3 3/4''' - 11''' . Niquelado y arenado.

 No 4039	32 gr.	Pce Fr.
---	--------	---------

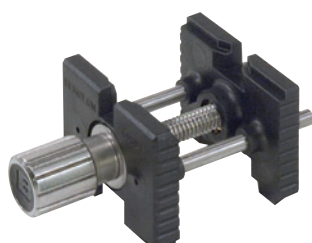

### Porte-pièce extensible et réversible synthétique

Pour calibres 3 3/4''' - 11''' . Serrage sur Ø extérieur de 12 à 30 mm.

### Dehn- und umkehrbarer synthetischer Werkhalter

Für Kaliber 3 3/4''' - 11''' . Festklemmen auf Ø äußerlich von 12 bis 30 mm.

### Extensible and reversible synthetic movement holder

For calibres 3 3/4''' - 11''' . Tightening on Ø external from 12 to 30 mm.

### Porta-máquina extensible y reversible sintético

Para calibres 3 3/4''' - 11''' . Sujeción sobre Ø exterior de 12 a 30 mm.

 No 4039-P	13 gr.	Pce Fr.
---	--------	---------

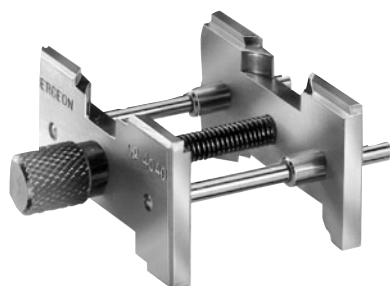

### Porte-pièce extensible et réversible

Pour calibres 8 3/4''' - 19''' . Nickelé et sablé.

### Dehn- und umkehrbarer Werkhalter

Für Kaliber 8 3/4''' - 19''' . Vernickelt und sandgestrahlt.

### Extensible and reversible movement holder

For calibres 8 3/4''' - 19''' . Nickelled and sanded.

### Porta-máquina extensible y reversible

Para calibres 8 3/4''' - 19''' . Niquelado y arenado.

 No 4040	40 gr.	Pce Fr.
---	--------	---------

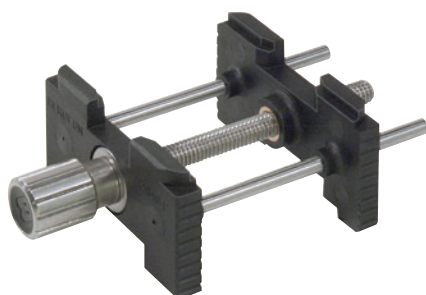

### Porte-pièce extensible et réversible synthétique

Pour calibres 8 3/4''' - 19''' . Serrage sur Ø extérieur de 30 à 48 mm.

### Dehn- und umkehrbarer synthetischer Werkhalter

Für Kaliber 8 3/4''' - 19''' . Festklemmen auf Ø äußerlich von 30 bis 48 mm.

### Extensible and reversible synthetic movement holder

For calibres 8 3/4''' - 19''' . Tightening on Ø external from 30 to 48 mm.

### Porta-máquina extensible y reversible sintético

Para calibres 8 3/4''' - 19''' . Sujeción sobre Ø exterior de 30 a 48 mm.

 No 4040-P	15 gr.	Pce Fr.
---	--------	---------

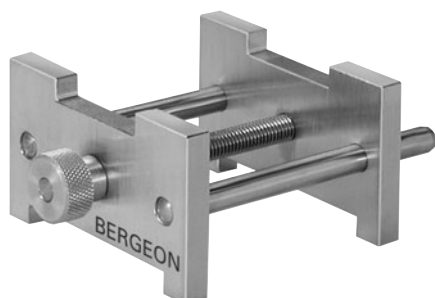

### Porte-pièce extensible et réversible

Pour montres de poche . Nickelé . Serrage sur Ø extérieur de 25 à 62 mm.

### Dehn- und umkehrbarer Werkhalter

Für Taschenuhren . Vernickelt . Festklemmen auf Ø äußerlich von 25 bis 62 mm.

### Extensible and reversible movement holder

For pocket watches . Nickelled . Tightening on Ø external from 25 to 62 mm.

### Porta-máquina extensible y reversible

Para relojes de bolsillo . Niquelado . Sujeción sobre Ø exterior de 25 a 62 mm.

 No 3021	145 gr.	Pce Fr.
---	---------	---------



# BERGEON

Depuis 1791

Tél. + 41 32 933 60 00  
Fax + 41 32 933 60 01

www.bergeon.ch  
info@bergeon.ch

## Porte-pièce réversible avec bouton

Forme ronde.  
Autres formes sur demande.  
Préciser le calibre.

## Umkehrbarer Werkhalter mit Knopf

Runde Form.  
Andere Formen auf Anfrage.  
Kaliber angeben.

## Reversible movement holders with knob

Round shape.  
Other shapes on request.  
Indicate the calibre.

## Porta-máquina reversibles con botón

Forma redonda.  
Otras formas sobre demanda.  
Indicar el calibre.



No 5914...







No 5914-P...





En laiton nickelé.  
Aus vernickeltes Messing.  
In nickelled brass.  
En latón niquelado.

En matière synthétique (PMMA).  
Aus synthetisches Material (PMMA).  
In synthetic matter (PMMA).  
En materia sintética.

	 gr.	Pce Fr.
4 1/4'''	9	
5'''	9	
5 1/4'''	9	
5 1/2'''	10	
5 3/4'''	10	
6'''	10	
6 1/2'''	10	
6 3/4'''	10	
7'''	10	
7 1/4'''	10	
7 1/2'''	10	
7 3/4'''	10	
8'''	10	
8 1/4'''	10	
8 3/4'''	10	

	 gr.	Pce Fr.
9'''	13	
9 1/4'''	13	
9 1/2'''	13	
9 3/4'''	13	
10 1/2'''	13	
10 3/4'''	13	
11'''	18	
11 1/4'''	18	
11 1/2'''	18	
11 3/4'''	18	
12'''	20	
12 1/4'''	20	
12 1/2'''	20	
12 3/4'''	20	
13'''	24	

	 gr.	Pce Fr.
13 1/4'''	13	
13 1/2'''	13	
13 3/4'''	13	
14'''	13	
14 1/2'''	13	
16'''	18	
16 1/2'''	18	
17'''	18	
18'''	18	
18 1/2'''	20	
19'''	20	
19 1/2'''	20	
22'''	20	

## Porte-pièces

Laiton nickelé. Forme ronde.  
Dimension: Ø de base 31.0 mm.  
Autres modèles sur demande.

## Werkhalter

Messing vernickelt. Runde Form.  
Masse: Ø der Basis 31.0 mm.  
Andere Modelle auf Anfrage.

## Movements holder

Nickel-plated brass. Round shape.  
Dimension: base Ø 31.0 mm.  
Other models on request.

## Porta-máquinas

Latón niquelado. Forma redonda.  
Dimensión: Ø del base 31.0 mm.  
Otras modelos sobre demanda.



### Valjoux No 7750 13 1/4'''

Modèle réversible, percé, avec bouton et 2 poussoirs 2 h. et 4 h.

Reversible Modell, gebohrt, mit Druckknopf bei 2 und 4 Uhr

Reversible model, drilled, with push button and 2 pushers at 2 and 4 o'clock.

Modelo reversible, perforados, con botón y 2 pulsadores 2 h. y 4 h.

No 5914-7750

90 gr.

Pce Fr.



# BERGEON

Depuis 1791

Tél. + 41 32 933 60 00  
Fax + 41 32 933 60 01

www.bergeon.ch  
info@bergeon.ch

## Brucelles recouvertes de Teflon

En acier. Pour l'électronique, l'horlogerie, etc.  
Grande précision et finesse.  
Pour la manutention des pièces microscopiques. Teinte verte.  
Antimagnétiques. Inoxydables.

## Kornzangen mit Teflon bedeckt

Aus Stahl. Für Elektronik, Uhrenindustrie, usw.  
Grosse Präzision und Feinheit.  
Zur Handhabung von mikroskopischen Teilen. Grün.  
Antimagnetisch. Rostfrei.

## Tweezers covered in Teflon

In steel. For electronics, watchmaking, etc.  
High precision and fine tips for handling of microscopic pieces.  
Green coloured.  
Anti-magnetic. Stainless.

## Pinzas recubiertas de Teflon

En acero. Para electrónica, o relojería, etc.  
Muy precisas y finas.  
Para manipular piezas microscópicas. Color verde.  
Antimagnéticas. Inoxidables.

Fines, soignées pour spiraux - Sehr fein für Spiralen  
Fine, excellent for hairsprings - Finas, para espirales



No 7029-3T	14 gr.	10 pces Fr.	Pce Fr.
------------	--------	-------------	---------

A mettre plat les aiguilles - Zum Flachrichten der Zeiger  
For flattening hands - Para aplanar minutos



No 7029-FT	15 gr.	10 pces Fr.	Pce Fr.
------------	--------	-------------	---------

## Brucelles aux verres

Nouvelle forme de brucelles, conçues spécialement pour saisir tous types de verres avec aisance.  
En acier inoxydable.  
Embouts de rechange en matière synthétique.  
Longueur: 120 mm.

## Kornzangen für Gläser

Neue Form der Kornzangen, speziell entwickelt, um alle Arten von Gläser mit Leichtigkeit zu erfassen.  
Aus Edelstahl.  
Ersatzspitzen aus synthetischem Material.  
Länge: 120 mm.

## Tweezers for glasses

New form of tweezers, specially designed to handle all types of glasses very easily.  
Stainless steel.  
Replacement tips of synthetic material.  
Length: 120 mm.

## Pinzas para lentes

Nueva forma de pinzas, especialmente diseñadas para manipular todo tipo de lentes con facilidad.  
En acero inoxidable.  
Puntas de recambio en materia sintética.  
Longitud: 120 mm.

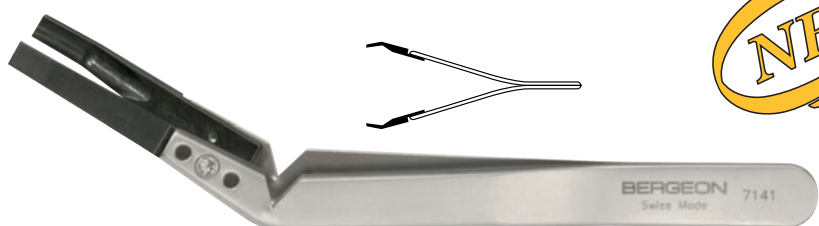

No 7141	16 gr.	Pce Fr.
---------	--------	---------



**Brucelles négatives.** Longueur: 120 mm.  
**Negative Kornzange.** Länge: 120 mm.  
**Negative tweezers.** Length: 120 mm.  
**Pinzas negativas.** Largo: 120 mm.

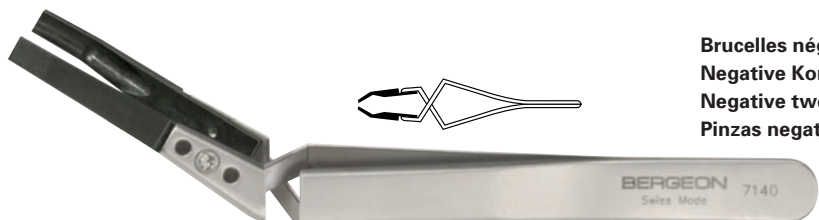

No 7140	16 gr.	Pce Fr.
---------	--------	---------

**Embouts de rechange en matière synthétique.** 1 paire.  
**Ersatzspitzen aus synthetischem Material.** 1 Paar.  
**Replacement tips of synthetic material.** 1 pair.  
**Puntas de replazo en materia sintética.** 1 par.



No 7140-BR	2.5 gr.	Pce Fr.
------------	---------	---------



# BERGEON

Depuis 1791

Tél. + 41 32 933 60 00  
Fax + 41 32 933 60 01

www.bergeon.ch  
info@bergeon.ch

**Assortiments de  
8 brucelles d'horlogerie**

**Sätze von 8 Kornzangen  
für die Uhrenindustrie**

**Sets of 8 tweezers  
for watch industry**

**Surtidos de  
8 pinzas de relojería**

 SWISS MADE

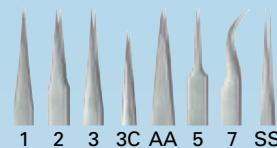

### Antimagnétiques

Très bonne résistance à la corrosion, aux produits acides et alcalins.

### Antimagnetisch

Sehr guter Widerstand auf Korrosion, Säuren und Alkali.

### Antimagnetics

Very good resistance to corrosion, acids and alkaline products.

### Antimagnéticos

Muy buena resistencia a la corrosión, a los productos ácidos y alcalinos.



No 7026

293 gr.

Pce Fr.



### Acier inoxydable

Magnétiques. Endurcies par traitement thermique, d'où des pointes très dures et fortes. Utilisées si une haute résistance à la corrosion n'est pas demandée.

### Edelstahl

Magnetisch. Gehärtet durch thermische Behandlung, daher sehr harte und starke Spitzen. Zu verwenden, wenn ein Korrosionswiderstand nicht gefragt ist.

### Stainless steel

Magnetics. Hardened by thermic treatment, therefore very hard and strong tips. Used if a high resistance to corrosion is not needed.

### Acero inoxidable

Magnéticos. Endurecidas por tratamiento térmico, de donde las puntas muy duras y fuertes. Utilizadas si una alta resistencia al corrosión non se pide.



No 7027

278 gr.

Pce Fr.



### Superalloy (Ni-Cr-Mo)

Très haute résistance thermique jusqu'à 800° C et six fois plus dure que l'acier inoxydable. 100% non-magnétique. Résistance à la corrosion, aux produits acides et alcalins.

### Superalloy (Ni-Cr-Mo)

Sehr hoher Temperaturwiderstand bis zu 800 Grad Celcius und sechsmal härter als Edelstahl. 100 % nicht magnetisch. Widerstand auf Korrosion, Säuren und Alkali.

### Superalloy (Ni-Cr-Mo)

Very high thermic resistance, up to 800°C and six times harder than stainless steel. 100% antimagnetic. Resistance to corrosion, acids and alkaline product.

### Superalloy (Ni-Cr-Mo)

Muy alta resistencia térmica asta 800° C y seis veces más duro que el acero inoxidable. 100% non magnético. Resistencia a la corrosión, a los productos ácidos y alcalinos.



No 7028

295 gr.

Pce Fr.





**Brucelles d'horlogerie**

**Uhrmacherkornzangen**



**Tweezers for watch industry**

**Pinzas de relojería**

 **SWISS MADE**



120 mm



	Antimagnetic	<b>No 7026-1</b>	15 gr.	Pce Fr.
	Inox	<b>No 7027-1</b>	14 gr.	Pce Fr.
	Superalloy	<b>No 7028-1</b>	26 gr.	Pce Fr.



120 mm



	Antimagnetic	<b>No 7026-2</b>	16 gr.	Pce Fr.
	Inox	<b>No 7027-2</b>	15 gr.	Pce Fr.
	Superalloy	<b>No 7028-2</b>	28 gr.	Pce Fr.



120 mm



	Antimagnetic	<b>No 7026-3</b>	15 gr.	Pce Fr.
	Inox	<b>No 7027-3</b>	14 gr.	Pce Fr.
	Superalloy	<b>No 7028-3</b>	27 gr.	Pce Fr.



110 mm



	Antimagnetic	<b>No 7026-3C</b>	13 gr.	Pce Fr.
	Inox	<b>No 7027-3C</b>	12 gr.	Pce Fr.
	Superalloy	<b>No 7028-3C</b>	24 gr.	Pce Fr.



110 mm



	Antimagnetic	<b>No 7026-5</b>	14 gr.	Pce Fr.
	Inox	<b>No 7027-5</b>	13 gr.	Pce Fr.
	Superalloy	<b>No 7028-5</b>	25 gr.	Pce Fr.



115 mm



	Antimagnetic	<b>No 7026-7</b>	15 gr.	Pce Fr.
	Inox	<b>No 7027-7</b>	14 gr.	Pce Fr.
	Superalloy	<b>No 7028-7</b>	27 gr.	Pce Fr.



130 mm



	Antimagnetic	<b>No 7026-AA</b>	18 gr.	Pce Fr.
	Inox	<b>No 7027-AA</b>	17 gr.	Pce Fr.
	Superalloy	<b>No 7028-AA</b>	30 gr.	Pce Fr.

140 mm



	Antimagnetic	<b>No 7026-SS</b>	14 gr.	Pce Fr.
	Inox	<b>No 7027-SS</b>	13 gr.	Pce Fr.
	Superalloy	<b>No 7028-SS</b>	25 gr.	Pce Fr.

**Hors assortiment**



**Nicht im Sortiment**

**Not in assortment**

**No en el surtido**



120 mm



	Antimagnetic	<b>No 7026-00</b>	14 gr.	Pce Fr.
	Inox	<b>No 7027-00</b>	13 gr.	Pce Fr.
	Superalloy	<b>No 7028-00</b>	25 gr.	Pce Fr.

110 mm



	Antimagnetic	<b>No 7026-4</b>	14 gr.	Pce Fr.
	Inox	<b>No 7027-4</b>	13 gr.	Pce Fr.
	Superalloy	<b>No 7028-4</b>	25 gr.	Pce Fr.





www.bergeon.ch  
info@bergeon.ch

# BERGEON

Depuis 1791

Tél. + 41 32 933 60 00  
Fax + 41 32 933 60 01

Emploi Verwendung Application Usos	Observations Bemerkungen Observations Observaciones	 cm <sup>3</sup>	 gr.	No	Pce Fr.
<b>8513</b> Graisse silicone d'étanchéité, qualité normale. Silikon-Dichtungsfett. Normalqualität. Silicone insulation grease. Normal grade. Grasa silicona de hermeticidad, calidad normal.		10	15	<b>8513-10</b>	
		50	70	<b>8513-50</b>	
		100	145	<b>8513-100</b>	
		200	320	<b>8513-200</b>	
		1000	1450	<b>8513-1000</b>	
<b>8516</b> Graisse silicone d'étanchéité, qualité molle. Silikon-Dichtungsfett. Weiche Qualität. Silicone insulation grease. Soft grade. Grasa silicona de hermeticidad, calidad blanda.		10	15	<b>8516-10</b>	
		50	72	<b>8516-50</b>	
		200	550	<b>8516-200</b>	



Emploi Verwendung Application Usos	Observations Bemerkungen Observations Observaciones	 cm <sup>3</sup>	 gr.	No	Pce Fr.
<b>8950 FIXODROP FK/K</b> <b>Solution concentrée.</b> Pour le traitement du plastique. <b>Konzentrierte Lösung.</b> Für die Behandlung von Plastik. <b>Concentrated solution.</b> For the treatment of plastics. <b>Solución concentrada.</b> Para el tratamiento del plástico.		100	320	<b>8950-100</b>	
		1000	2360	<b>8950-1000</b>	
<b>8951 FIXODROP FK/K10</b> <b>Solution prête à l'emploi.</b> Pour le traitement du plastique. <b>Gebrauchsfertige Lösung.</b> Für die Behandlung von Plastik. <b>Ready-to-use solution.</b> For the treatment of plastics. <b>Solución dispuesta para el uso.</b> Para el tratamiento del plástico.		100	320	<b>8951-100</b>	
		250	800	<b>8951-250</b>	
		1000	2360	<b>8951-1000</b>	
<b>8940 FIXODROP FK/BS</b> <b>Solution concentrée.</b> Contient 10 x plus de produit actif que le No 8941 FK/BS10. Diluer uniquement avec le produit: TETRADECAFLUOROHEXANE. Pour le traitement des rubis ainsi que pour l'acier, le laiton et autres métaux. <b>Konzentrierte Lösung.</b> Enthält 10 Mal mehr des aktiven Produktes als die Nr. 8941 FK/BS10. Ist nur mit dem Produkt: TETRADECAFLUOROHEXANE zu verdünnen. Zur Behandlung von Rubin, sowie für Stahl, Messing und andere Metalle. <b>Concentrated solution.</b> Contains 10 times more of active product than No Nr. 8941 FK/BS10. Dilute only with: TETRADECAFLUOROHEXANE. For the treatment of ruby as well as steel, brass and other metals. <b>Solución concentrada.</b> Contiene 10 veces más producto activo que el No 8941 FK/BS10. Diluir únicamente con el producto: TETRADECAFLUOROHEXANE. Para el tratamiento de los rubis, así como el acero, el latón y otros metales.		100	320	<b>8940-100</b>	
		1000	2360	<b>8940-1000</b>	
<b>8941 FIXODROP FK/BS10</b> <b>Solution prête à l'emploi.</b> Pour le traitement des rubis ainsi que pour l'acier, le laiton et autres métaux. <b>Gebrauchsfertige Lösung.</b> Zur Behandlung von Rubin, sowie für Stahl, Messing und andere Metalle. <b>Ready-to-use solution.</b> For the treatment of ruby as well as steel, brass and other metals. <b>Solución dispuesta para el uso.</b> Para el tratamiento de los rubis, así como el acero, el latón y otros metales.		100	320	<b>8941-100</b>	
		250	800	<b>8941-250</b>	
		1000	2360	<b>8941-1000</b>	

**MOEBIUS**  
member of  
**SWATCH GROUP**

### Epilame

Destiné aux traitements de surfaces pour éviter l'étalement de certaines huiles.

### Epilame

Für die Vorbehandlung von Oberflächen zur Verhinderung des Breitleaufens von Öl.

### Epilame

For the use in surface treatment to prevent the spreading of oil.

### Epilame

Destinado a tratamiento de superficies para evitar el esparcimiento de ciertos aceites.





# BERGEON

Depuis 1791

Tél. + 41 32 933 60 00  
Fax + 41 32 933 60 01

www.bergeon.ch  
info@bergeon.ch



### Flacon pour épilame

En verre. Pour utilisation des produits Moebius-Fixodrop No 8940, 8941, 8950, 8951, planche 9186.

### Fläschchen für Epilame

Aus Glas. Für Benutzung der Produkte Moebius-Fixodrop Nr. 8940, 8941, 8950, 8951, Seite 9186.

### Bottle for epilame

In glass. For use of the products Moebius-Fixodrop No 8940, 8941, 8950, 8951, page 9186.

### Frasco para epilame

En vidrio. Para utilización los productos Moebius-Fixodrop No 8940, 8941, 8950, 8951, página 9186.

No 7066	191 gr.	Pce Fr.
---------	---------	---------



### Flacon seul Nur Fläschchen Only bottle Solo frasco

No 7066-F	157 gr.	Pce Fr.
-----------	---------	---------

### Panier seul Nur Korb Only basket Sola cesta

No 7066-P	34 gr.	Pce Fr.
-----------	--------	---------



### Huile pour montres à quartz

Lubrifiant synthétique à champ d'application universel pour montres à quartz analogiques. Compatible avec les plastiques.

Température d'emploi: -36° C. à + 80° C. Très bonne adhérence. Ne s'étale pas. S'utilise avec le pique-huile ou le huileur automatique. Contenu: 2 cm<sup>3</sup>.

### Oel für Quarzuhren

Synthetisches Schmiermittel, universelle Anwendung, für Analog-Quarzuhren. Verträglich mit Kunststoffen.

Anwendungstemperatur: von: -36° C. bis + 80° C. Sehr gute Haftung. Kein Breitlaufen. Wird gebraucht mit Oelgeber oder automatischem Oeler. Inhalt: 2 cm<sup>3</sup>.

### Oil for quartz watches

Synthetic lubricant with a wide range of applications for analog quartz watches. Excellent compatibility with plastics.

Working temperature: -36° C. à + 80° C. Very good adherence. Does not spread. To be applied by standard or automatic oilers. Contents: 2 cm<sup>3</sup>

### Aceite para relojes de cuarzo

Lubricante sintético con un campo de aplicación universal para relojes de cuarzo analógicos. Compatible con los plásticos.

Temperatura de empleo: -36° C. à + 80° C. Muy buena adherencia. No se desparrama. Se utiliza con un pica aceite o un aceitador automático. Contenido: 2 cm<sup>3</sup>.

No 9000	10 gr.	Dz Fr.	Pce Fr.
---------	--------	--------	---------



www.bergeon.ch  
info@bergeon.ch

# BERGEON

Depuis 1791

Tél. + 41 32 933 60 00  
Fax + 41 32 933 60 01

## Tissus 100% microfibre

Recommandé spécialement pour l'essuyage des pièces ou composants en or très sensibles aux rayures ainsi que verres de montres avec anti-reflet.

### Propriétés:

- lavable à 40° C.
- non-contaminant
- ne relargue pas de fibres.

**Conditionnement:** livré par paquet de 100 pièce

## Gewebe 100% Mikrofaser

Besonders zum Abtrocknen von Gold Stücken kratzempfindlichen, sowie Antireflex Uhrgläsern.

### Eigenschaften:

- Bei 40°C waschbar
- Fuselfrei
- Nicht ansteckend.

**Verpackung:** Pakete zu 100 Stück

## Wipers 100% Microfibre

Especially recommended for the wiping of gold item or component highly sensitive to scratches as well as anti-reflecting watch glasses.

### Properties:

- Washable at 40°C
- Not contaminant
- Do not reject fibres.

**Packaging:** Delivered by package of 100 pieces

## Tejido 100% microfibra

Recomendado especialmente para el pulido de las piezas o los componentes de oro muy sensibles a las rayas así como los cristales de reloj con antireflejo.

### Propiedades:

- Lavable a 40 ° C.
- No contaminan
- no se deshilachan.

**Acondicionamiento:** entregado por paquete de 100 piezas.



230 x 230 mm	No 7039	786 gr.	Pce Fr.
--------------	---------	---------	---------

## Tissus polypropylène

Pour tout nettoyage de pièces ou surfaces grasses, imbibé de 70% isopropyl, 30% eau déionisée.

### Propriétés:

- fort pouvoir dégraissant.
- tissu propre, pour cat. ISO3
- ne relargue pas de fibres
- jetable.

### Conditionnement:

livré par sachet de 50 pièces.

## Gewebe Polypropylene

Für jegliche Reinigung von fettigen Teilen oder Oberflächen.

Mit 70% Isopropyl und 30% deionisiertem Wasser angereichert.

### Eigenschaften:

- Stark entfettend
- Sauberes Gewebe, für Kat. ISO3
- Fuselfrei
- Wegwerfbar.

**Verpackung:** Pakete zu 50 Stück.

## Wipers Polypropylene

For cleaning of greasy piece surfaces, soaked with 70% isopropyl, 30% of deionised water.

### Properties:

- Strong grease-removing capacity
- Clean tissue for cat. ISO3
- Do not reject fibres
- Disposable.

**Packaging:** Delivered by package of 50 pieces.

## Toallitas polipropileno

Para toda la limpieza de las piezas o superficies grasas, prehumedecidas con 70% alcohol isopropilico y 30% agua desmineralizada.

### Propiedades:

- fuerte poder desengrasante
- Tejido limpio, para cat. ISO3
- no se deshilacha
- desechable.

**Acondicionamiento:** entregadas por paquete de 50 piezas.

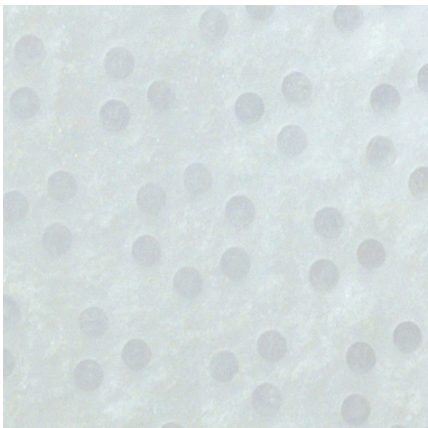

230 x 280 mm	No 7040	455 gr.	Pce Fr.
--------------	---------	---------	---------



## Sticks de nettoyage

### Avantages:

- Nouvelle qualité.
- Matière et structure des têtes, idéales pour tous travaux de nettoyages.
- Ne s'effilochent pas.



## Reinigungsstäbchen

### Vorteile:

- Neue Qualität.
- Material und Struktur der Spitzen ideal für alle Reinigungsarbeiten.
- Es Fasert nicht.

## Swabs for cleaning

### Advantages:

- New quality.
- Material and structure, of the tips, ideal for all cleaning work.
- Does not fringe.

## Bastoncillos de limpieza

### Ventajas:

- Nueva calidad.
- Materia y estructura, de las cabezas, ideales para todos los trabajos de limpiezas.
- No se hilacha.

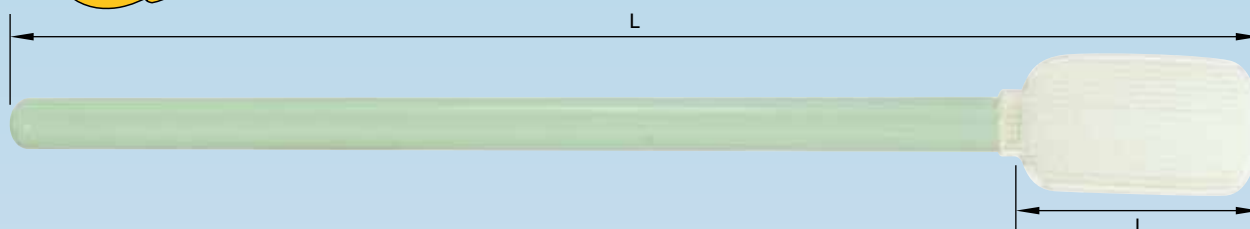

Matière Material Material Materia	L mm	l mm	No	Forme Form Shape Forma	
Polyester thermosoudé Polyester thermo geschweisst Polyester thermally bonded Polyester thermo soldado	90	15	7007-08		100 pces / Fr.
	120	22	7007-09		100 pces / Fr.
	165	16	7007-10		100 pces / Fr.
	73	14	7007-12		500 pces / Fr.
	70	10	7007-13		500 pces / Fr.
	70	12	7007-14		500 pces / Fr.
Mousse polyuréthane thermosoudée Polyurethanschaum thermo geschweisst Foam Polyurethane thermally bonded Esponja de polyuretano thermo soldada	65	15	7007-11		500 pces / Fr.
	76	11	7007-15		500 pces / Fr.
	70	11	7007-16		500 pces / Fr.
	130	22	7007-17		50 pces / Fr.
Microfibre thermosoudée Microfiber thermo geschweisst Microfibre thermally bonded Microfibra thermo sodada	147	20	7007-18		125 pces / Fr.
Mousse caoutchouc et polyuréthane inséré Schaum- Rubber und Polyurethan einsatz Foam rubber and polyurethane insert Esponja de caucho y polyuretano inserido	85	17	7007-19		100 pces / Fr.



Tél. + 41 32 933 60 00  
Fax + 41 32 933 60 01

# BERGEON

Depuis 1791

www.bergeon.ch  
info@bergeon.ch

## Tissus microfibre

Très résistants, non imprégnés. Particulièrement utilisés pour nettoyer, polir et manipuler tous types de verres, montres et bracelets métalliques ainsi que les métaux précieux, semi-précieux et pierres précieuses.

Utilisation à sec ou avec un produit nettoyant. Lavable à 40°.

Impression personnalisée de haute qualité résistante au lavage.

**Sur demande:** divers coloris.

## Gewebe Mikrofaser

Sehr widerstandsfähig, nicht imprägniert.

Besonders geeignet zum Reinigen, Polieren und Handhaben aller Gläserarten, metallische Uhren und Armbänder wie die Edelmetallen und Halbmetallen sowie Edelsteinen.

Anwendung trocken oder mit einem Reinigungsmittel. Waschbar bei 40°.

Persönliche Note mit Aufdruck in Spitzenqualität, waschbar.

**Auf Anfrage:** verschiedenen Farben.

## Wipers microfibrés

Highly resistant, non-impregnated. Very useful to clean, to polish and to operate all kinds of glasses, metal watches and bracelets as well precious, semi-precious metals and precious stones.

For dry use or with a cleaning product. Washable at 40° C.

High quality customised printing, wash resistant.

**On request:** various colours.

## Tejido microfibra

Muy resistente, non impregnada. Particularmente utilizada para limpiar, pulir y manipular todos los tipos de vidrios, lojes y pulseras metálicos así como metales preciosos y medio-preciosos así que las piedras preciosas.

Utilización a seco o con un producto para la limpieza. Lavable a 40°C.

Impresión personalizado de alta calidad resistente al lavaje.

**Sobre pedido:** varios colores.



Sérigraphie - Siebdruck - Silk-screenprinting - Serigrafía



Gaufrage - Einprägung - Embossing - Encañonage



-N



-B

No	~ mm		gr.	Pce Fr. / 1000	Pce Fr. / 100	Pce Fr. / 10	Pce Fr.
7850-BER-...	300 x 350		25				
7850-2-...	250 x 250	Neutre - Neutral - Neutro	20				
7850-3-...	300 x 350	Neutre - Neutral - Neutro	25				



www.bergeon.ch  
info@bergeon.ch

**BERGEON**

Depuis 1791

Tél. + 41 32 933 60 00  
Fax + 41 32 933 60 01

### Gants en microfibre

Très résistants, non imprégnés. Particulièrement utilisés en boutique pour nettoyer, polir et manipuler tous types de verres, métaux précieux ainsi que les pierres précieuses et semi-précieuses.

**Adaptés pour les travaux en salle blanche.**

Utilisation à sec ou avec un produit nettoyant. Lavable à 40°C.

**Sur demande:** divers coloris.

Impression personnalisée de haute qualité résistante au lavage.

**Pour commander:** préciser le **No de l'article** ainsi que la **taille**.

### Original Mikrofaser Handschuhe

Sehr widerstandsfähig, nicht imprägniert.

Besonders geeignet in Geschäft zum Reinigen, Polieren und Handhaben aller Gläserarten, metallische Uhren und Armbänder wie die Edelmetallen und Halbmetallen sowie Edelsteinen. **Geeignet für Arbeiten in Reinraum.**

Anwendung trocken oder mit einem Reinigungsmittel. Waschbar bei 40°C.

**Auf Anfrage:** verschiedenen Farben. Persönliche Note mit Aufdruck in Spitzenqualität, waschbar.

**Bei Bestellung:** die **Nr. des Artikels** sowie die **Grösse** angeben.

### Gloves in microfibres

Highly resistant, non-impregnated. Very useful in shop to clean, to polish and to operate all kinds of glasses, metal watches and bracelets as well precious, semi-precious metals and precious stones.

**Adapted to work in clean room.**

For dry use or with a cleaning product. Washable at 40°C.

**On request:** various colours.

High quality customised printing, wash resistant.

**To order:** please, precise the **ref. number** together with the **size**.

### Guantes de microfibra

Muy resistente, non impregnada. Particularmente utilizada en tienda para limpiar, pulir y manipular todos los tipos de vidrios, lojes y pulseras metálicos así como metales preciosos y medio-preciosos así que las piedras preciosas.

**Adaptado par trabajar en sala blanca.**

Utilización a seco o con un producto para la limpieza. Lavable a 40°C.

**Sobre pedido:** varios colores.

Impresión personalizado de alta calidad resistente al lavaje.

**Para el pedido:** precisar el **No del artículo** así que la **medida**.



Sérigraphie - Siebdruck - Silk-screenprinting - Serigrafía



Gaufrage - Einprägung - Embossing - Encañonage



100



100



	No	gr.	S			M			L			XL		
			Fr./100	Fr./10	Fr.	Fr./100	Fr./10	Fr.	Fr./100	Fr./10	Fr.	Fr./100	Fr./10	Fr.
○	7851-B	20												
●	7851-N	20												



# BERGEON

Depuis 1791

Tél. + 41 32 933 60 00  
Fax + 41 32 933 60 01

www.bergeon.ch  
info@bergeon.ch

## Mallette d'outils pour le rhabillage et le SAV

En cuir très soigné.  
**Contient:** 42 outils et accessoires  
spécialisés.

## Werkzeugtasche für die Reparatur und den Nachverkaufs-Service

Aus sorgfältigem Leder.  
**Enthält:** 42 Werkzeuge  
und spezielle Zubehörteile.

## Tools kit for watchmaking after-sale service

Very carefully made leather case.  
**Contents:** 42 specialized tools  
and accessories.

## Estuche de herramientas para reparaciones y para taller de composturas

En cuero esmerado.  
**Contiene:** 42 herramientas  
y accesorios específicos.



No 6817-09

1.900 Kg

Pce Fr.



<b>No 7026-1/5</b>  <b>No 8082-B</b> 	Brucelles Kornzangen Tweezers Pinzas				Ass. d'équarisseurs Sort. Reibahlen Ass. cutting broaches Sur. escaridados <b>No 1896-G</b>  7103-A
<b>No 7026-F</b>  <b>No 8082-C</b> 	Brucelles Kornzangen Tweezers Pinzas				Porte-pièces Werkhalter Mouvement holder Porta máquinas <b>No 4040-P</b>  7103-A
<b>No 5394-PG</b> 	Coussin d'emboîtement: Ø 80 mm Einschaltungskissen: Ø 80 mm Casing cushion: Ø 80 mm Almohadilla-apoyo: Ø 80 mm				Huile synthétique "Moebius" Flasche mit Öl "Moebius" Bottle synthetic "Moebius" Botellita de aceite "Moebius" <b>No 9010-2</b>  9181
<b>No 2834-C</b> 	Gratte-brosses Kratzbürste Scratch-brush Grata hilo				Ass. piques-huile Sort. Ölgeber Ass. oilers Sur. pica-aceite <b>No 30102-4</b>  7016-M
<b>No 30081-...</b>  <b>8000-C/E</b> 	9 Tournevis: Ø 0.50-2.50 mm 9 Schraubenzieher: Ø 0.50-2.50 mm 9 Screwdrivers: Ø 0.50-2.50 mm 9 Destornilladores: Ø 0.50-2.50 mm				Pierre India India-Stein "INDIA" stone Piedra India <b>No 1945-34M</b>  4073
<b>No 30081-T</b>  <b>8000-D</b> 	5 Tubes de mèches de rechange: Ø 0.50-1.20 mm 5 Tuben Ersatzklingen: Ø 0.50-1.20 mm 5 Tubes with spare blades: Ø 0.50-1.20 mm 5 Tubos de mechas de recambio: Ø 0.50-1.20 mm				Support pour cadran Träger für Zifferblätter Base for dialplates Zócalo para esferas <b>No 7053-N</b>  N-7050-B
<b>No 6767-S</b>  <b>7007-G</b> 	Outil aux barrettes Federstege-Werkzeug Spring-bars tool Sacapasadores				Microscope Lupe Loupe Lupa <b>No 1458-A12</b>  6106
<b>No 30019</b>  <b>7050</b> 	2 Leviers fins pour aiguilles 2 Feine Hebel für Zeiger 2 Fine hands-levers 2 Palanquitas finas para agujas				Microscope Lupe Loupe Lupa <b>No 4422-3</b>  6101
<b>No 7404-1</b>  <b>7056-A</b> 	Outil à poser les aiguilles Werkzeug zum Zeigersetzen Hands setting tool Útil para colocar las agujas				"RODICO PREMIUM" "RODICO PREMIUM" "RODICO PREMIUM" "RODICO PREMIUM" <b>No 7033-1</b>  9121-B
<b>No 7404-2</b>  <b>7056-A</b> 	Outil à poser les aiguilles Werkzeug zum Zeigersetzen Hands setting tool Útil para colocar las agujas				Microfibre "Micro-Clair" Mikrofaser "Micro-Clair" "Micro-Clair" micro fibres Microfibra "Micro-Clair" <b>No 6850-...</b>  4122
<b>No 7404-3</b>  <b>7056-A</b> 	Canif et ouvre-boîtes Messer mit Gehäuseöffner Knife and case opener Navajitas y abre cajas				Microfibre "Micro-Clair" Mikrofaser "Micro-Clair" "Micro-Clair" micro fibres Microfibra "Micro-Clair" <b>No 2963-B</b>  6036-B
<b>No 6403</b>  <b>7007-J6</b> 	Canif et ouvre-boîtes Messer mit Gehäuseöffner Knife and case opener Navajitas y abre cajas				Microfibre "Micro-Clair" Mikrofaser "Micro-Clair" "Micro-Clair" micro fibres Microfibra "Micro-Clair" <b>No 2963-B</b>  6036-B
<b>No 1282-D</b>  <b>4106-E</b> 	Cabron de peau + protège cabron 4056-6 Lederfeile + Lederfeilenschutz 4056-6 Leather buff + buffs protector 4056-6 Pulidor en piel + protección 4056-6				3 Tubes 3 Tuben 3 Tubes 3 Tubos <b>No 2963-B</b>  6036-B
<b>No 6460-P</b>  <b>8078</b> 	Brucelles en plastique Plastik-Kornzangen Plastic tweezers Pinzas plásticas				
<b>No 30636-1</b>  <b>7051</b> 	Outil "PRESTO" "PRESTO" Werkzeug "PRESTO" tools "PRESTO" herramienta				<b>Contenu:</b> 42 outils et accessoires spécialisés. <b>Inhalt:</b> 42 Werkzeuge und spezielle Zubehörteile. <b>Contents:</b> 42 specialized tools and accessories. <b>Contenido:</b> 42 herramientas y accesorios específicos.

Tél. + 41 32 933 60 00  
Fax + 41 32 933 60 01

**B**  
**BERGEON**  
Depuis 1791

www.bergeon.ch  
info@bergeon.ch

### Potence à ouvrir et fermer les boîtes étanches

Nouveaux socle et étau spécialement conçu pour pièces de grandes dimensions.

Ouverture jusqu'à 60 mm.

Socle bois: 250 x 95 mm.

Hauteur totale: 300 mm.

Ø du volant: 130 mm.

Bâti en fonte injectée.

### Presstock zum Öffnen und Schliessen wasser- dichter Uhrgehäuse

Neuen Sockel und Schraubstock speziell hergestellt für Gehäuse mit Grossen Durchmesser.

Öffnung bis 60 mm.

Holzsockel: 250 x 95 mm.

Gesamthöhe: 300 mm.

Schwungrad Ø : 130 mm.

Gestell aus Spritzguss.

### Device for opening and closing waterproof watch cases

New base and vice especially created for big cases. Opening up to 60 mm.

Wooden stand: 250 x 95 mm.

Total height: 300 mm.

Ø of the hand wheel: 130 mm.

Die-cast frame.

### Potenza para abrir y cerrar las cajas impermeables

Nuevo zócalo y torno especialmente concebido para partes de grandes dimensiones.

Apertura hasta 60 mm.

Zócalo de madera: 250 x 95 mm.

Altura total: 300 mm.

Ø del volante: 130 mm.

Armadura de fundición inyectada.



#### Comprenant - Mit - Including - Con:

	2x	No 2835-A
	2x	No 2835-B
	2x	No 2835-C
	2x	No 2835-D
	2x	No 2835-E
	2x	No 2835-F
	4x	9-11 mm 13-15 mm 17-19 mm 20-22 mm
	1x	No 5700-04-G

Socle bois - Holzsockel - Wooden stand - Zócalo de madera.

	No 5700-Z	2.950 kg	Pce Fr.
--	-----------	----------	---------



**Etai seul.** Ouverture jusqu'à 60 mm.

**Nur Schraubstock.** Öffnung bis 60 mm.

**Vice alone.** Opening up to 60 mm.

**Solo tornillo.** Apertura hasta 60 mm.

No 5700-04-G	214 gr.	Pce Fr.
--------------	---------	---------

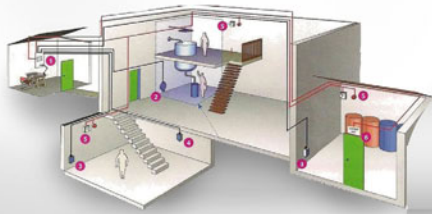

**Optimisation de vos espaces de travail  
Ihr Arbeitsräume Optimisiert  
Optimization of your workspaces  
Optimización de sus espacios de trabajo**

**Solutions incluant équipements et impératifs logistiques**

- Maîtrise des contraintes techniques
- Maîtrise des énergies
- Un ou plusieurs postes de travail
- Solution clés en mains

**Lösungen, die logistische Ausstattungen und Ihre Wünschen umfassen**

- *Beherrschung der technischen Zwänge*
- *Energie Beherrschung*
- *Ein oder mehrere Arbeitsplätze*
- *Komplette Lösungen*

**Solutions including equipments and logistic requirements**

- Control technical constraints
- Energies Control
- One or more work stations
- Turn-key solutions

**Soluciones que incluyen equipamientos e imperativos logísticos**

- *Dominio de las dificultades técnicas*
- *Control de energías*
- *Uno o varios puestos de trabajo*
- *Solución clave en manos*

Machines et équipements  
*Maschinen und Ausstattungen*  
Machines and equipments  
*Máquinas y equipamientos*



Maîtrise des énergies  
*Energie Beherrschung*  
Energies Control  
*Dominio de las energías*



**Solutions de personnalisation de vos produits  
Personal Lösungen für Ihre Produkte  
Private label solutions for your tools  
Soluciones de personalización para sus productos**



**Solutions intégrées et visuels stratégiques**

- Layout intégré dans la démarche marketing
- Recherche de solutions avec votre département marketing
- Projet 3D
- Modélisation 3D
- Personnalisation de la gamme «Essentiel»
- Gravage Laser

**Integrierte Lösungen und Strategischen Sichten**

- *Layout integriert im Marketing Prozess*
- *Lösungssuche mit Ihrem Marketing*
- *Projekte 3D*
- *Modellbau 3D*
- *Personifizierung von «Essentiel» Produkten*
- *Lasergravierung*

**Integrated Solutions and Visual Strategy**

- Integrated Layout in the Marketing procedure
- Solutions research with your Marketing
- 3D Project
- 3D Modeling
- Personnalisation of «Essentiel» range
- Laser engraving

**Soluciones integradas y visuales estratégico**

- *Layout integrada en la gestión Marketing.*
- *Búsqueda de soluciones con su comercialización*
- *Proyecto 3D*
- *Modelización 3D*
- *Personalización de la gama «Essentiel»*
- *Marcage Láser*





Retrouvez tous nos produits en ligne  
Finden Sie alle unsere Produkte online  
Find all our products online  
Encuentre todos nuestros productos online

[www.bergeon.ch](http://www.bergeon.ch)



Outillages et équipements pour l'horlogerie, la bijouterie et la microtechnique

**BERGEON SA**  
11, av. du Technicum  
CH - 2400 Le Locle

Tél. + 41 32 933 60 00  
Fax + 41 32 933 60 01

[www.bergeon.ch](http://www.bergeon.ch)  
[info@bergeon.ch](mailto:info@bergeon.ch)