

**NEWS**



**BASELWORLD**

24.03 - 31.03.2011

Hall | Stand  
**3u | D20**

**Site Internet** comprenant :

- Shop en ligne, téléchargements
- vidéos, fiches techniques
- Informations générales,

**Web Seite** umfasst :

- Shop on ligne,
- Unterladen von vidéos,
- technische Daten
- Allgemeine Informationen

**Web site** containing :

- On Line shop,
- Downloading videos,
- technical datas
- General informations

**Portal Internet** que incluye :

- Shop en línea,
- descargas,
- videos,
- fichas técnicas
- Información general



- Le catalogue **Général**,
- Catalogue **Essentiel**
- **site internet.**

- The **general** Catalog
- **Essentiel** Catalog
- **Web site**

- *Der Haupt Katalog*
- *Essentiel Katalog*
- *Webseite*

- *El catálogo General,*
- *Catálogo Essentiel*
- *Portal Internet.*



**Usinage/fabrication**

- CNC
- **Gravage Laser**
- **Assemblage**

**Machining/Production**

- CNC
- **Laser engraving**
- **Assembling**

**Herstellung/Produktion**

- CNC
- **Lasergravierung**
- **Montage**

**Producción/fabricación**

- CNC
- **Marcage Láser**
- **Montaje**

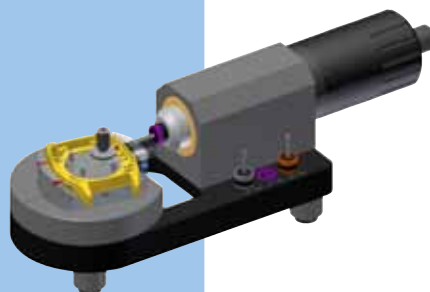

SolidWorks

- R+D, en collaboration avec vos Bureaux méthodes, SAV, et industrialisation
- Prise en charge de vos contraintes
- Evolution possibles en cours de projet

- *R+D, in Zusammenarbeit mit Ihren Kundendiensten, und technische Abteilung*
- *Industrialisierung*
- *Integrierung Ihre Vorzüge*
- *Evolution jederzeit möglich*

- R&D, in cooperation with your After sales service, method office and industrialization
- Taking care of your restraints
- Possible evolution while a project in process

- *I+D, en colaboración con sus oficinas métodos, SAV, e industrialización*
- *Encarga de sus dificultades*
- *Evoluciones posibles en curso de proyecto*

- Maîtrise des contraintes techniques
- Maîtrise des énergies
- Un ou plusieurs postes de travail
- Solution clés en mains

- Control technical constraints
- Energies Control
- One or more work stations
- Turn-key solutions

- *Beherrschung der technischen Zwänge*
- *Energie Beherrschung*
- *Ein oder mehrere Arbeitsplätze*
- *Komplette Lösungen*

- *Dominio de las dificultades técnicas*
- *Control de energías*
- *Uno o varios puestos de trabajo*
- *Solución clave en manos*



Machines et équipements  
*Maschinen und Ausstattungen*  
Machines and equipments  
*Máquinas y equipamientos*



Maîtrise des énergies  
*Energie Beherrschung*  
Energies Control  
*Dominio de las energías*



- **Optimisation des espaces**
- **Solutions incluant équipements et impératifs logistiques**

- *Optimierung der Räume*
- *Lösungen, die logistische Ausstattungen und Ihre Wünschen umfassen*

- **Spaces optimization**
- **Solutions including equipments and logistic requirements**

- **Optimización de espacios**
- **Soluciones que incluyen equipamientos e imperativos logísticos**

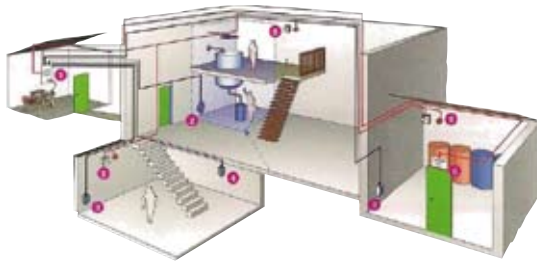

- **Lay-out** intégré dans la démarche marketing.
- **Recherche** de solutions avec votre marketing
- **Projet 3D**
- **Modélisation 3D**

- *Lay-out integriert im Marketing Prozess*
- *Lösungssuche mit Ihrem Marketing*
- *Projekte 3D*
- *Modellbau 3D*

- Integrated **Lay-out** in the Marketing procedure
- **Solutions** research with your Marketing
- **3D Project**
- **3D Modeling**

- *Lay-out integrada en la gestión Marketing.*
- *Búsqueda de soluciones con su comercialización*
- *Proyecto 3D*
- *Modelización 3D*



- **Solutions intégrées**
- **Visuels stratégique**
- **Personnalisation** de la gamme «Essentiel»
- **Gravage Laser**

- **Integrated Solutions**
- **Visual Strategy**
- **Personnalisation** of «Essentiel» range
- **Laser engraving**

- *Integrierte Lösungen*
- *Strategischen Sichten*
- *Personifizierung* von «Essentiel» Produkten
- *Lasergravierung*

- *Soluciones integradas*
- *Visuales estratégico*
- *Personalización* de la gama «Essentiel»
- *Marcage Láser*





# BERGEON

Depuis 1791

Tél. + 41 32 933 60 00  
Fax + 41 32 933 60 01

www.bergeon.ch  
info@bergeon.ch

## Machine pour le remontage des montres automatiques

### Duotest

Nouvelle machine conçue spécialement pour le SAV.

La Duotest fonctionne en mode programmable hebdomadaire, en mode minuterie et en marche continue.

#### Caractéristiques techniques:

- Capacité: 48 têtes de montre ou 48 montres avec bracelet.
- Fréquence de rotation: 1 ou 4 cycles/min.
- Porte-boîtes pour conditionnement avec couvercle 130 x 130 mm avec 4 compartiments.
- Encombrement: 56 x 60 x 33 cm.
- Alimentation: 230 ou 115 V (tableau de commande: 24 V).

## Maschine zum Aufziehen der automatischen Uhren

### Duotest

Neue Maschine eignet sich hervorragend für das Service-werkstätte.

DUOTEST funktioniert in wöchentlichen programmier-bar Modus, Timer Modus und andauernden Lauf Modus.

#### Technische Daten:

- Kapazität: 48 Uhren mit oder ohne Band.
- Drehfrequenz: 1 oder 4 Zyklen/Min.
- Schachteln Halter mit Deckel: 130 x 130 mm mit 4 Fächern
- Abmessungen: 56 x 60 x 33 cm.
- Strom: 230 oder 115 V (Bedienerfeld: 24V).

## Machine for winding automatic watches

### Duotest

New machine designed specifically for the After Sales Service.

DUOTEST operates in program-mable weekly mode timer and continues mode.

#### Technical data:

- Capacity: 48 watch cases only or 48 watches with strap.
- Rotation frequency: 1 or 4 cycles/min.
- Carrier boxes for packing with lid 130 x 130 mm with 4 compartments.
- Size: 56 x 60 x 33 cm.
- Power: 230 or 115 V (control panel: 24 V).

## Máquina para el remontaje de los relojes automáticos

### Duotest

Nueva máquina diseñada específicamente para el servicio técnico.

DUOTEST opera en el modo de temporizador semanal programa-ble y continúa la operación.

#### Características técnicas:

- Capacidad: 48 cajas de reloj o 48 relojes con correa.
- Frecuencia de rotación: 1 o 4 ciclos/min.
- Puerta de cajas para el embalaje con tapa 130 x 130 mm con 4 compartimentos.
- Dimensiones: 56 x 60 x 33 cm.
- Potencia: 230 o 115 V (panel de control: 24 V).



# ASTUTO



No 7163-115	37 Kg	Pce Fr.
-------------	-------	---------

No 7163-230	37 Kg	Pce Fr.
-------------	-------	---------

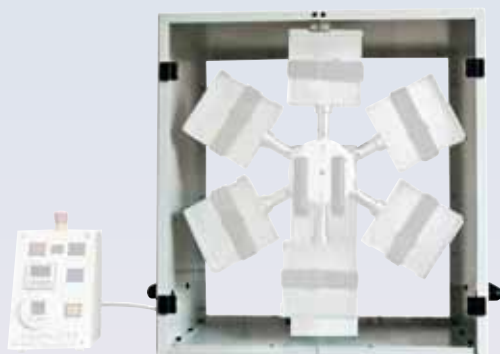

**Caisson de protection**  
**Schutzkasten mit Glastüren**  
**Protective box with glass doors**  
**Caja de protección con puertas de cristal**

No 7163-48	18 Kg	Pce Fr.
------------	-------	---------





**BERGEON**

Depuis 1791

Tél. + 41 32 933 60 00  
Fax + 41 32 933 60 01

www.bergeon.ch  
info@bergeon.ch

**Paniers de lavage**

En aluminium revêtu de TEFLON. Haut niveau de finition des séparations, garantit une bonne circulation des solutions de lavage.

La légèreté des matériaux utilisés favorise un essorage parfait.

Le revêtement préserve les pièces des rayures.

Convient à des installations de lavage.

**Jeu complet:** 1 support, 9 paniers et 1 couvercle.

Eviter l'usage de fluor, de diméthylformamide ainsi que de bases concentrées.

**Waschkörbe**

In Aluminium, mit TEFLON Beschichtung.

Hohes Fertigstellungsniveau der Fächer garantiert einen guten Kreislauf der Reinigungslösungen.

Die Leichtigkeit von die verwendete Materialien ergibt ein perfektes Schleudern.

Die Beschichtung schützt die Teile vor Kratzer.

Passt zu Reinigungseinrichtungen.

**Komplett Satz:** 1 Halter, 9 Körbe, 1 Deckel.

Gebrauch von Fluor und Dimethylformamid vermeiden, sowie konzentrierten Lösungen.

**Cleaning baskets**

In aluminum with TEFLON coating. High finition level of the separations guarantees a good circulation of the cleaning solutions.

The lightness of the used materials favors a perfect wringing.

The coating protects the parts from scratches.

Suits to cleaning machines.

**Complete set:** 1 support, 9 baskets and 1 lid.

Avoid the use of fluorine, dimethylformamide as well as concentrated bases.

**Cestas de lavado**

De aluminio recobrido de TEFLÓN. El alto nivel de acabado de las separaciones garantiza una buena circulación de las soluciones de lavado.

La ligereza de los materiales utilizados favorece un escurrido perfecto.

El recobrido preserva las piezas de los rasguños.

Conviene instalaciones de lavado.

**Juego completo:** 1 soporte, 9 cestas y 1 tapa.

Evitar el uso de flúor, de dimethylformamide así como de bases concentradas.



No 7043



7043-02



7043-01

7043-11

7043-07



Ø 80 mm ⇨ 16 mm

7043-06



7043-04

7043-05

7043-03

Petits paniers à baïonnette en acier inox.  
Kleine Verschlusskörbe aus Edelstahl.  
Small stainless steel baskets with bayonet closing.  
Pequeñas cestas en "baïonette" de acero inoxidable.

Ø 18 mm ⇨ 13 mm



7043-08

Ø 24 mm ⇨ 14 mm



7043-09



7043-10



No	gr.	Pce Fr. / 100	Pce Fr. / 10	Pce Fr.
7043	197			
7043-01	17.2			
7043-02	17.5			
7043-03	19.5			
7043-04	20.5			
7043-05	20.7			
7043-06	18			
7043-07	21			
7043-08	3.65			
7043-09	5.95			
7043-10	31.5			
7043-11	13			



**Paniers de lavage**

En acier inox.  
Haut niveau de finition des séparations, garantit une bonne circulation des solutions de lavage.  
La légèreté des matériaux utilisés favorise un essorage parfait.  
Convient à des installations de lavage.  
**Jeu complet:** 1 support, 9 paniers et 1 couvercle.  
Eviter l'usage de fluor, de diméthylformamide ainsi que de bases concentrées.

**Waschkörbe**

In Edelstahl.  
Hohes Fertigstellungsniveau der Fächer garantiert einen guten Kreislauf der Reinigungslösungen.  
Die Leichtigkeit von die verwendete Materialien ergibt ein perfektes Schleudern.  
Passt zu Reinigungseinrichtungen.  
**Komplett Satz:** 1 Halter, 9 Körbe, 1 Deckel.  
Gebrauch von Fluor und Dimethylformamid vermeiden, sowie konzentrierten Lösungen.

**Cleaning baskets**

In stainless steel.  
High finition level of the separations guarantees a good circulation of the cleaning solutions.  
The lightness of the used materials favors a perfect wringing.  
Suits to cleaning machines.  
**Complete set:** 1 support, 9 baskets and 1 lid.  
Avoid the use of fluorine, dimethylformamide as well as concentrated bases.

**Cestas de lavado**

De acero inoxidable.  
El alto nivel de acabado de las separaciones garantiza una buena circulación de las soluciones de lavado.  
La ligereza de los materiales utilizados favorece un escurrido perfecto.  
Conviene instalaciones de lavado.  
**Juego completo:** 1 soporte, 9 cestas y 1 tapa.  
Evitar el uso de fluor, de dimethylformamide así como de bases concentradas.



No 7043-I



7043-I-02



7043-I-01



7043-I-11



Ø 80 mm ⇄ 16 mm

7043-I-07



7043-I-04

7043-I-05

7043-I-03

Petits paniers à baïonnette en acier inox.  
Kleine Verschlusskörbe aus Edelstahl.  
Small stainless steel baskets with bayonet closing.  
Pequeñas cestas en "baïonnette" de acero inoxidable.

Ø 18 mm ⇄ 13 mm



7043-08

Ø 24 mm ⇄ 14 mm



7043-09



7043-10



No	gr.	Pce Fr. / 100	Pce Fr. / 10	Pce Fr.
7043-I	197			
7043-I-01	17.2			
7043-I-02	17.5			
7043-I-03	19.5			
7043-I-04	20.5			
7043-I-05	20.7			
7043-I-06	18			
7043-I-07	21			
7043-I-08	3.65			
7043-I-09	5.95			
7043-I-10	31.5			
7043-I-11	13			



# BERGEON

Depuis 1791

Tél. + 41 32 933 60 00  
Fax + 41 32 933 60 01

www.bergeon.ch  
info@bergeon.ch

## Tournevis avec contrôle du couple

Commande programmable pour tous modèles de tournevis.

- Un coffret de commande pour plusieurs tournevis.
- Affichage des paramètres de vissage.
- Multilingue.
- Vitesse de vissage réglable.
- Couple de vissage et dévissage réglable.
- Mesures automatiques du couple de vissage.
- Mesures automatiques du couple de dévissage.

## Schraubenzieher mit Drehmomentkontrolle

Programmierbare Steuerung für alle Arten von Schraubenziehern.

- Eine Steuerung für mehrere Schraubendreher.
- Display-Einstellungsschrauben.
- Mehrsprachige.
- Geschwindigkeit einstellbar Schraube.
- Paar- und Abschrauben einstellbar.
- Automatische Messung des Drehmoments.
- Automatische Messung von Abschrauben Drehmoment.

## Screwdriver with torque control

Programmable control for all types of screwdrivers.

- A control box for several screwdrivers.
- Display settings screwing.
- Multilingual.
- Speed adjustable screw.
- Couple of screwing and unscrewing adjustable.
- Automatic measurement of torque.
- Automatic measurement of unscrewing torque.

## Destornillador con control de torque

Control programable torquea todos los tipos de destornilladores.

- Una caja de control torquea varios destornilladores.
- Ajustes de la pantalla atornillar.
- Multilingüe.
- Velocidad de tornillo ajustable.
- Un torque de atornillar y desatornillar ajustable.
- Medición automática de torque.
- Medición automática de desenroscar torque.



No 7176

580 gr.

Pce Fr.



Reconnaissance automatique de la tête de vissage  
Automatische Erkennung des Schrauberkopfs  
Automatic detection of the screwdriver head  
Reconocimiento automático de la cabeza del tornillo

No 7176-41

690 gr.

Pce Fr.





# BERGEON

Depuis 1791

Tél. + 41 32 933 60 00  
Fax + 41 32 933 60 01

www.bergeon.ch  
info@bergeon.ch

## Tournevis ergonomiques en aluminium

La nouvelle gamme de tournevis propose des outils alliant qualité technique et confort d'utilisation. Les tournevis sont garnis d'une membrane en élastomère assurant un contact idéal entre l'outil et la main, alors que la tête octogonale améliore le confort.

**Corps:** Aluminium anodisé.  
**Manche:** Garnitures élastomère TPE.

**Tête:** En matière synthétique POM (Delrin) autolubrifiant.

**Mèches:** Acier inox durci.

## Ergonomischen Schraubenziehern in Aluminium

Die neue Serie von Schraubenziehern bietet Werkzeuge an, welche technische Qualität und komfortable Anwendung miteinander verbinden. Die Schraubenzieher sind mit einem Überzug aus Elastomer ausgestattet, welcher einen idealen Kontakt zwischen Werkzeug und der Hand gewährleistet, sowie einem oktogonalen Kopf, welcher die Handhabung verbessert.

**Schaft:** Eloxiertes Aluminium.

**Überzug:** Elastomer TPE.

**Kopf:** aus synthetischem Material POM (Delrin), selbstschmierend.

**Klingen:** Edelstahl gehärtet.

## Ergonomic screwdrivers in aluminium

The new screwdriver range's tools combine technical quality and confort of use. The screwdrivers are provided with an elastomer membran which assures an ideal contact between the tool and the hand, while the octagonal head enhances the confort.

**Shank:** Anodized aluminium.

**Handle:** TPE elastomer coat.

**Head:** Self-lubricating, synthetic POM (Delrin) material.

**Blades:** Hardened stainless steel.

## Destornilladores ergonómicos en aluminio

La nueva gama de destornilladores combine la calidad técnica y el confort de uso. Los destornilladores son cubiertos de una membrana de elastómero que asegura un contacto ideal entre la herramienta y la mano, mientras tanto la cabeza octágonal mejora el confort.

**Cuerpo:** Aluminio anodizado.

**Mancha:** Guarnición elastómero TPE.

**Cabeza:** de materia sintética POM (Delrin) autolubrificante.

**Mechas:** De acero inoxidable endurecido.



No 7899

90 gr.

Pce Fr.

 SWISS MADE



### Jeu de 9 tournevis sur socle tournant.

Avec emplacement pour les mèches de rechange.

**Drehbare Sockel mit 9 Schraubenziehern.**

Markierten Reservoiren für Ersatzklingen.

**Rotating stand with 9 screwdrivers.**

Coloured slots for spare blades.

**Surtido de 9 destornilladores sobre zócalo giratorio.**

Con emplazamiento para las mechas de recambio.

Ø 0.50 - 0.60 - 0.80 - 1.00 - 1.20 - 1.40 - 1.60 - 2.00 - 2.50 mm.



### Jeu de 10 tournevis sur socle tournant.

Avec emplacements pour les tubes et mèches de rechange.

**Drehbare Sockel mit 10 Schraubenziehern.**

Markierten Reservoiren für Ersatzklingen.

**Rotating stand with 10 screwdrivers.**

Coloured slots for spare blades.

**Surtido de 10 destornilladores sobre zócalo giratorio.**

Con emplazamiento para las mechas de recambio.

Ø 0.50 - 0.60 - 0.80 - 1.00 - 1.20 - 1.40 - 1.60 - 2.00 - 2.50 - 3.00 mm.

No 7899-S09

320 gr.

Pce Fr.

No 7899-S10

930 gr.

Pce Fr.





Tél. + 41 32 933 60 00  
Fax + 41 32 933 60 01

# BERGEON

Depuis 1791

www.bergeon.ch  
info@bergeon.ch

## Nouvel appareil à contrôler l'étanchéité des boîtes de montres

**A pression d'air.**

Cylindre amovible pour vidanger. Raccord pour compresseur ou pompe. Mise en pression manuelle de 0 à 11 atm.

Crochet pour montre en matière synthétique.

**Capacité de contrôle: 0-11 atm. (sécurité à 12 atm.).**

Bâti en fonte d'aluminium.

Robuste, très stable.

Cylindre Ø int.: 70 mm.

Capacité de contenance: 2 montres.

Dimensions: 275 x 167.5 x 390 mm.

## Neu Apparat zur Kontrolle der Wasserdichtigkeit von Uhrgehäusen

**Mit Luftdruck.**

Zylinder abnehmbar zur Entleerung. Anschluss für Kompressor oder Pumpe. Druckregulierung von 0-11 Atü.

Haken für Uhr aus synthetischem Material.

**Kontrollkapazität 0-11 Atü (Sicherheit bei 12 Atü).**

Gestell aus Aluminiumguss.

Robust und sehr stabil.

Zylinder Innen Ø: 70 mm.

Kapazität: 2 Uhren.

Dimensionen: 275 x 167.5 x 390 mm.

## New apparatus for testing the water resistance of watch cases

**Air pressure system.**

Removable cylinder for draining. Connector for compressor or pump.

Manual pressure from 0 to 10 atm.

Hook for synthetic matter watch.

**Control Capacity : 0-11 atm. (security at 12 atm).**

Built in aluminium cast iron.

Strong, very stable.

Cylinder Ø: 70mm.

Volume capacity: 2 watches.

Dimensions: 275 x 167.5 x 390 mm.

## Nuevo aparato para controlar la impermeabilidad de las cajas de relojes

**Con presión de aire.**

Cilindro amovible para desaguar. Conectado para compresor o bomba. Puesta en presión manual de 0 a 10 atm.

Gancho para reloj en materia sintética.

**Capacidad de control: 0-11atm. Seguridad a 12 atm.**

Bastidor de fundición de aluminio.

Robusto, muy estable.

Cilindro Ø int.: 70mm.

Capacidad: 2 relojes.

Dimensiones: 275 x 167.5 x 390 mm.

## BERGEON No 5555/10

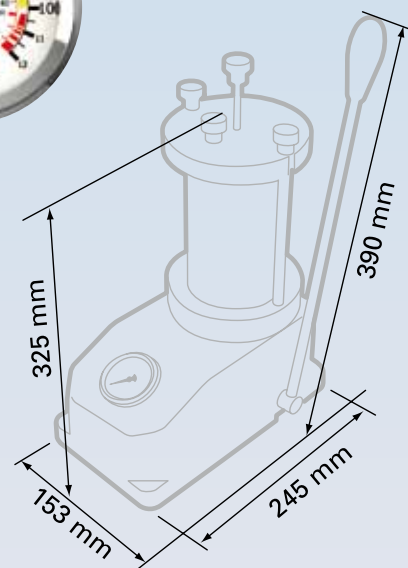



**Cylindre amovible pour vidanger**  
**Zylinderv abnehmbar zur Entleerung**  
**Removable cylinder for draining**  
**Cilindro amovible para desaguar**



No 5555/10-TP	545 gr.	Pce Fr.
---------------	---------	---------

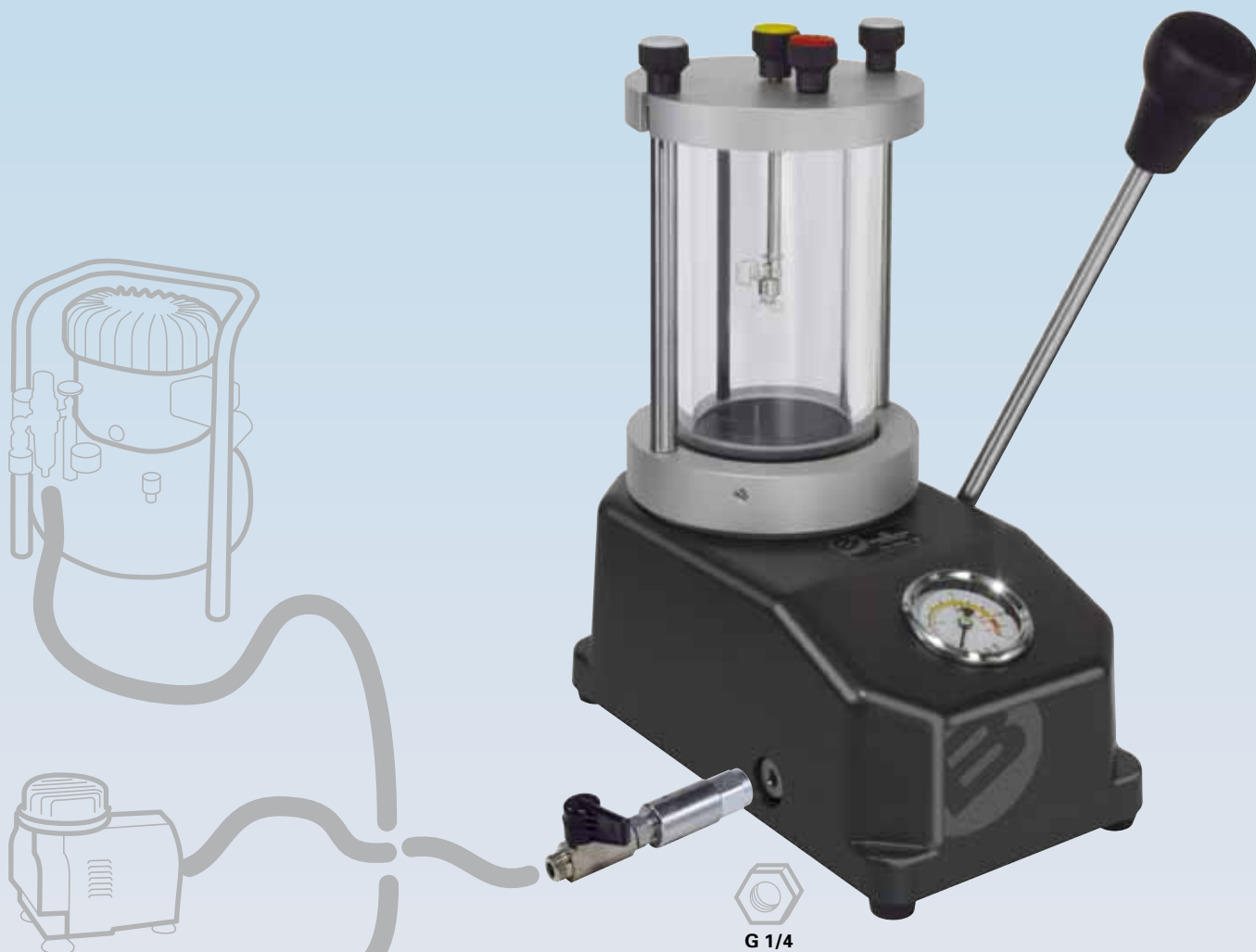

  
G 1/4

**Raccord pour compresseur ou pompe**  
**Anschluss für Kompressor oder Pump**  
**Connector for compressor or pump**  
**Conectado para compresor o bomba**

No 5555/10-R	545 gr.	Pce Fr.
--------------	---------	---------



# BERGEON

Depuis 1791

Tél. + 41 32 933 60 00  
Fax + 41 32 933 60 01

www.bergeon.ch  
info@bergeon.ch

## Dispositif pour perforer les bracelets

Réalisé pour un travail efficace et pratique.

Structure en aluminium.

Forme ergonomique et très maniable.

Permet d'effectuer des trous de toutes formes dans des bracelets en cuir, tissu ou caoutchouc.

Épaisseur: 4.5 mm max.

Largeur: 26 mm max.

Se compose de poinçons, matrices et pions de centrage.

Réglage simple de l'intervalle des trous.

Ø des trous ronds:

1.00, 1.50, 2.00, 2.50 et 3.00 mm

D'autres formes sur demande.

## Armbänderlochapparat

Speziell entwickelt um praktisch und effizient zu Arbeiten.

Struktur aus Aluminium.

In ergonomischer und handlicher Form.

Um Löcher mit verschiedenen Formen in Leder-, Stoff- oder Kautschukarmbänder zu machen.

Dicke: max. 4.5 mm.

Breite: max. 26 mm.

Geliefert mit Punzen, Matrize und Sperrstiften.

Einfache Einstellung vom Abstand den Löchern

Ø von runden Löchern:

1.00, 1.50, 2.00, 2.50 und 3.00 mm.

Andere Formen: auf Anfrage.

## Watch-strap punching device

Designed for a very efficient and practical work.

Aluminium frame.

Ergonomic and easy to use.

Enable to make holes of various shapes in leather, cloth or rubber straps.

Thickness: 4.5 mm max.

Width: 26 mm max.

Contains punches, dies and centring pins.

Easy setting of punching intervals.

Ø of round holes:

1.00, 1.50, 2.00, 2.50 and 3.00 mm.

Other shapes: on demand.

## Dispositivo para perforar las pulseras

Realizado para trabajar de modo eficaz y práctico.

Estructura en aluminio.

Forma ergonómica y de fácil manejo.

Permite efectuar agujeros de todas las formas en pulseras de cuero, tejido o caucho.

Espesor: 4.5 mm max.

Largura: 26 mm max.

Se compone de punzones, matrices y peones de centrado.

Regulación simple del intervalo de los agujeros.

Ø de agujeros redondos:

1.00, 1.50, 2.00, 2.50 y 3.00 mm.

De otras formas bajo petición.



Ecartement réglable - Einstellbare Pitch  
Adjustable Pitch - Ajustable de tono



No 30228

320 gr.

Pce Fr.

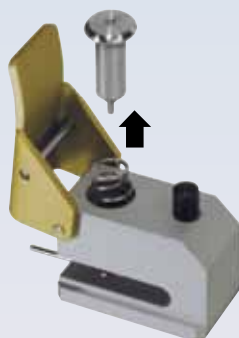

Changement rapide des poinçons et matrices.

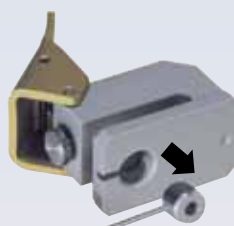

Schnelle änderung der Meißel und Matrizen.

Fast change of the punches and dies.

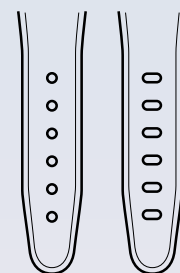

Cambio rápido de los punzones y matrices.



# BERGEON

Depuis 1791

Tél. + 41 32 933 60 00  
Fax + 41 32 933 60 01

www.bergeon.ch  
info@bergeon.ch

## Outil pour déchasser et chasser les goupilles de bracelets

L'outil permet de maintenir en bonne position les montres munies de bracelets métalliques afin de chasser et déchasser les goupilles de bracelet.

L'outil comporte divers ajustements permettant de centrer la goupille dans l'axe de la broche et est muni de dégagements pour l'évacuation des goupilles.

Protection caoutchouc sur la surface de travail.

Dimensions: 160 x 120 x 100 mm.

## Werkzeug zum Einpressen und Ausstossen der Armbandstifte

Das Werkzeug ermöglicht das Halten von Uhren mit Metallarmbändern in der gewünschten Stellung, um die Bandstifte einzupressen oder auszustossen.

Ausgestattet mit Auffangspalten für die Stifte weist das Werkzeug diverse Einstellmöglichkeiten auf, um die Bandstifte genau kozentrisch zum Ausstossstift anzuordnen.

Mit Gummischutz auf der Arbeitsfläche.

Masse: 160 x 120 x 100 mm.

## Tool to drive bracelet pins in and out

The tool is designed to maintain watches with metal bracelet in exact position to drive the pins in or out.

Equipped with enough space to enable the ejection of the pins, the pin's position can be adjusted in order to exactly align with the axis of the pin holder.

Rubber protection on top of working surface.

Dimensions: 160 x 120 x 100 mm.

## Útil para sacar y poner las clavijas de pulseras

Útil permite mantener en buena posición los relojes con pulseras metálicas para sacar y poner las clavijas de pulseras.

Con espacio suficiente para evacuar las clavijas, el soporte tiene diversos ajustamientos que permiten centrar todas las ranuras en el eje del porta clavijas.

Protección de caucho en la superficie de trabajo.

Medidas: 160 x 120 x 100 mm.

## MBA Swiss tool



No 7136

500 gr.

Pce Fr.





# BERGEON

Depuis 1791

Tél. + 41 32 933 60 00  
Fax + 41 32 933 60 01

www.bergeon.ch  
info@bergeon.ch

## Extracteurs HH pour lunettes tournantes

Poignée ergonomique en alu anodisé avec vis de réglage fin de butée pour éviter d'écraser la lunette.

Nouvelle bague en matière synthétique permettant l'extraction de tous types de lunettes tournantes sans griffer.

## HH Abheber für drehende Lünetten

Ergonomischer Griff in anodisiertem Aluminium mit Schraube zur Regulierung des Anschlages und Verhinderung dass die Lünette zerdrückt wird.

Neuer Ring in synthetischem Material zur Abhebung aller Arten von drehenden Lünetten ohne sie zu zerkratzen.

## HH extractors for rotating Bezels

Ergonomic handle in anodized aluminum with adjustable screw in end of banking to avoid crushing the Bezel.

New ring in synthetic material allowing the extraction of all kinds of rotating Bezels without scratching.

## Extractores HH de lunetas

Mango ergonómico en aluminio anodizado con tornillo de regulación para no atropellar la luneta.

Nueva anilla sintética para extracción sin rasguños de todo tipos de lunetas giratorias.



  
**BERGEON**  
Technologies

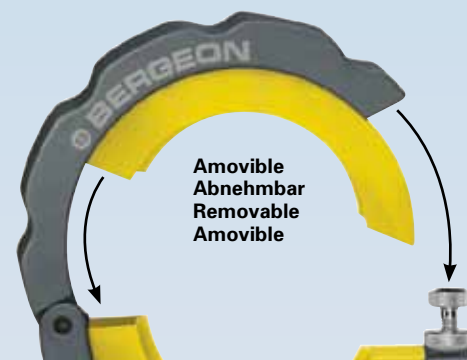
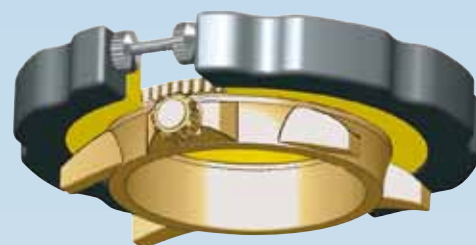
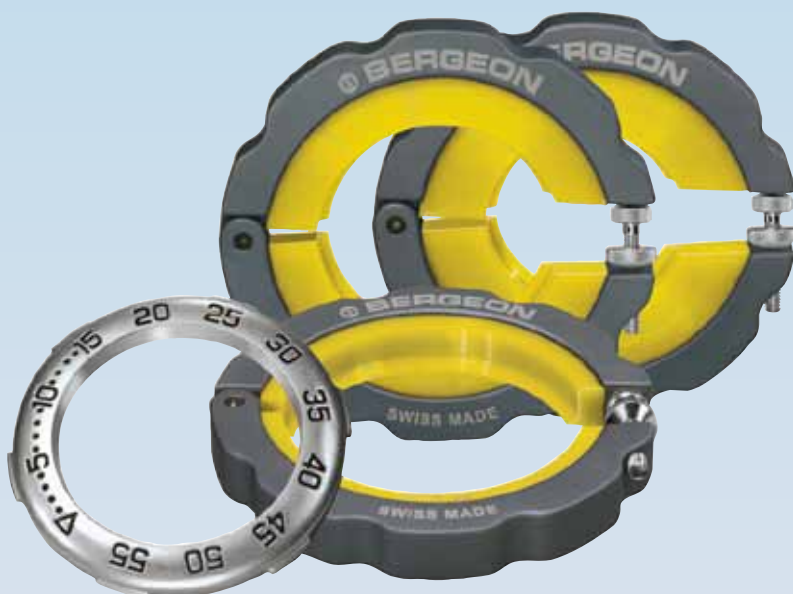

Amoveble  
Abnehmbar  
Removable  
Amovible

Assortiment de 6 pièces.

∅ intérieur de bague: 30 - 34 - 38 - 42 - 46 - 50 mm.

∅ extérieur de la poignée: 80 mm.

Sortiment von 6 Stück.

∅ inner Rings: 30 - 34 - 38 - 42 - 46 - 50 mm.

∅ äusserlich des Griffs: 80 mm.

Assortment of 6 pieces.

Interior ∅ of ring: 30 - 34 - 38 - 42 - 46 - 50 mm.

∅ external of the handle: 80 mm.

Surtidos de 6 piezas

∅ interior de anillo: 30 - 34 - 38 - 42 - 46 - 50 mm.

∅ exterior del punado: 80 mm.

No 7052

Pce Fr.

**Autres dimensions sur demande.**  
**Andere Dimensionen auf Antrag.**  
**Other dimensions on request.**  
**Otras dimensiones sobre demanda.**

Extracteurs seuls.  
Abheber allein.  
Only extractors.  
Extractores solo.

No 7052-...

Pce Fr.



# BERGEON

Depuis 1791

www.bergeon.ch  
info@bergeon.ch

Tél. + 41 32 933 60 00  
Fax + 41 32 933 60 01

## Extracteur de lunettes

Nouveau concept ergonomique permettant d'extraire plus aisément tous types de lunettes, allant de Ø 20 à 58 mm.

Le dispositif offre la possibilité d'intégrer différentes pinces et mors de serrage adaptés à la majorité des formes de lunettes.

### Descriptif:

- Manche en aluminium anodisé.
- Pince universelle en matière synthétique avec 3 jeux de mors amovibles (7820-M01=15° - 7820-M02 = 30° - 7820-M03 = 40°).
- 3 pièces d'appui central selon différences.

**Sur demande:** pinces spécifiques.

## Abheber für Lünetten

Neues ergonomisches Konzept für einfache Entfernung von alle Sorten von Lünetten mit Durchmesser von Ø 20 bis 58 mm.

Das Gerät kann mit verschiedene Zangen und Backen ausgerüstet werden für unterschiedliche Lünetten Formen.

### Beschreibung:

- Griff aus Eloxiertem Aluminium.
- Standard Zange aus Kunststoff mit 3 auswechselbare Backensätze (7820-M01=15° - 7820-M02 = 30° - 7820-M03 = 40°).
- 3 verschiedene Unterstützung scheiben.

**Auf Anfrage:** Kunde spezifische Zange

## Extractor for Bezels

New ergonomic concept allowing to extract more easily every kind of bezels, from Ø 20 to 58 mm.

The device offers the possibility of integrating various chucks and tightening jaws, adapted to the majority of bezel shapes.

### Description:

- Handle in anodized aluminium.
- Universal chuck in synthetic material with 3 sets of removable jaws (7820-M01=15° - 7820-M02 = 30° - 7820-M03 = 40°).
- 3 different central support pieces.

**On request:** blank chuck.

## Extractores de lunetas

Nuevo diseño ergonómico para facilitar la extracción de todo tipo de lunetas entre Ø 20 y 58 mm.

El dispositivo ofrece la posibilidad de integrar diferentes pinzas y mordazas de sujeción adaptado a la mayoría de las formas de lunetas.

### Descripción:

- Mango de aluminio anodizado.
- Alicates de plástico con 3 juegos de mordazas desmontables (7820-M01=15° - 7820-M02 = 30° - 7820-M03 = 40°).
- 3 piezas centrales de apoyo.

**Suplemento:** pinzas especiales.



No 7820	2.500 Kg.	Pce Fr.
---------	-----------	---------

**Pince ébauche**  
**Rohwerkzange**  
**Blank chuck**  
**Pinza "ébauches"**

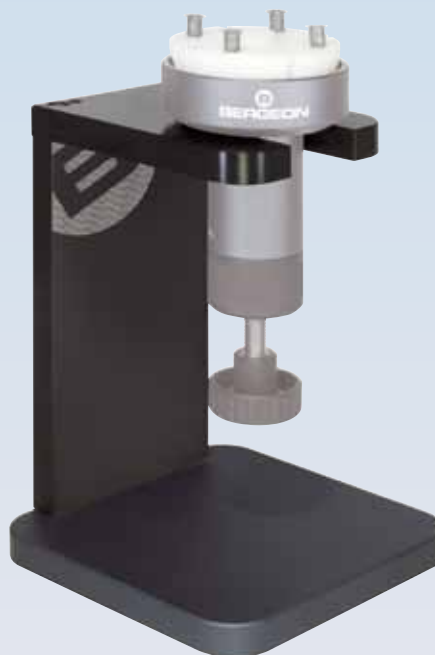

**Support:** apporte une meilleures stabilité à vos opérations d'extraction.  
**Halter:** bietet bessere Stabilität beim Lünetten-entfernung.  
**Support:** brings a better stability during operations of extraction.  
**Soporto:** proporciona una mejor estabilidad para la extracción.

No 7820-PE	150 gr.	Pce Fr.
------------	---------	---------

No 7820-001	1.660 Kg	Pce Fr.
-------------	----------	---------



# BERGEON

Depuis 1791

Tél. + 41 32 933 60 00  
Fax + 41 32 933 60 01

www.bergeon.ch  
info@bergeon.ch

## Potence à ouvrir et fermer les boîtes étanches

Nouveaux socle et étau spécialement conçu pour pièces de grandes dimensions.

Ouverture jusqu'à 60 mm.

Socle bois: 250 x 95 mm.

Hauteur totale: 300 mm.

Ø du volant: 130 mm.

Bâti en fonte injectée.

## Presstock zum Öffnen und Schliessen wasserdichter Uhrgehäuse

Neuen Sockel und Schraubstock speziell hergestellt für Gehäuse mit Grossen Durchmesser.

Öffnung bis 60 mm.

Holzsockel: 250 x 95 mm.

Gesamthöhe: 300 mm.

Schwungrad Ø : 130 mm.

Gestell aus Spritzguss.

## Device for opening and closing waterproof watch cases

New base and vice especially created for big cases. Opening up to 60 mm.

Wooden stand: 250 x 95 mm.

Total height: 300 mm.

Ø of the hand wheel: 130 mm.

Die-cast frame.

## Potenza para abrir y cerrar las cajas impermeables

Nuevo zócalo y torno especialmente concebido para partes de grandes dimensiones.

Apertura hasta 60 mm.

Zócalo de madera: 250 x 95 mm.

Altura total: 300 mm.

Ø del volante: 130 mm.

Armadura de fundición inyectada.



### Comprenant - Mit - Including - Con:

	2x	No 2835-A
	2x	No 2835-B
	2x	No 2835-C
	2x	No 2835-D
	2x	No 2835-E
	2x	No 2835-F
	4x	9-11 mm 13-15 mm 17-19 mm 20-22 mm
	1x	No 5700-04-G

### Socle bois - Holzsockel - Wooden stand - Zócalo de madera.

No 5700-Z	2.950 kg	Pce Fr.
-----------	----------	---------

### Socle matière synthétique - Sockel synthetisches Material. Synthetic stand matter - Zócalo materia sintética.

No 5700-Z-D	2.950 kg	Pce Fr.
-------------	----------	---------



**Etai seul.** Ouverture jusqu'à 60 mm.

**Nur Schraubstock.** Öffnung bis 60 mm.

**Vice alone.** Opening up to 60 mm.

**Solo tornillo.** Apertura hasta 60 mm.

No 5700-04-G	214 gr.	Pce Fr.
--------------	---------	---------



# BERGEON

Depuis 1791

www.bergeon.ch  
info@bergeon.ch

Tél. + 41 32 933 60 00  
Fax + 41 32 933 60 01

## Potence à ouvrir et fermer les boîtes étanches

Ouverture jusqu'à 60 mm.  
Socle bois: 250 x 95 mm.  
Hauteur totale: 300 mm.  
Ø du volant: 130 mm.  
Bâti en fonte injectée.

## Presstock zum Öffnen und Schliessen wasser- dichter Uhrgehäuse

Öffnung bis 60 mm.  
Holzsockel: 250 x 95 mm.  
Gesamthöhe: 300 mm.  
Schwungrad Ø: 130 mm.  
Gestell aus Spritzguss.

## Device for opening and closing waterproof watch cases











Opening up to 60 mm.  
Wooden stand: 250 x 95 mm.  
Total height: 300 mm.  
Ø of the hand wheel: 130 mm.  
Die-cast frame.

## Potenza para abrir y cerrar las cajas impermeables

Apertura hasta 60 mm.  
Zócalo de madera: 250 x 95 mm.  
Altura total: 300 mm.  
Ø del volante: 130 mm.  
Armadura de fundición inyectada.

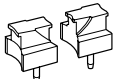

### Comprenant - Mit - Including - Con:

	2x	No 2835-A
	2x	No 2835-B
	2x	No 2835-C
	2x	No 2835-D
	2x	No 2835-E
	2x	No 2835-F
	4x	9-11 mm 13-15 mm 17-19 mm 20-22 mm No 5700-B-C-D-E
	6x	Ø 16 - 19 - 22 mm 26 - 30 - 34 mm No 5700-F-G-H-J-K-L
	3x	Ø 19 - 26 - 34 mm No 5700-M-N-P
	1x	No 5700-04-G

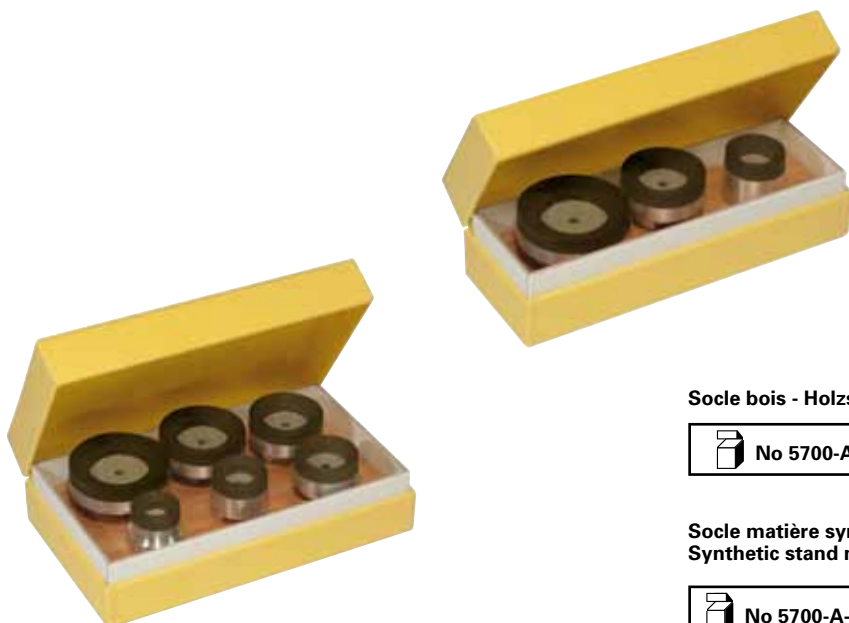

### Socle bois - Holzsockel - Wooden stand - Zócalo de madera.

 No 5700-A	3.450 kg	Pce Fr.
---	----------	---------

### Socle matière synthétique - Sockel synthetisches Material. Synthetic stand matter - Zócalo materia sintética.

 No 5700-A-D	3.450 kg	Pce Fr.
---	----------	---------





## Accessoires

### Tasseaux ventouses dessus, en adoprène

(Matière de grande adhérence).



**Grands diamètres. Tendre.**  
**Grosse Durchmesser. Weich.**  
**Big sizes. Soft.**  
**Grandes diámetros. Tierno.**

Ø mm	No	gr.	Pce Fr.
40	5700-52-40	25	
45	5700-52-45	31	
50	5700-52-50	36	

## Zubehörteile

### Obere Saugstempel aus Adipren

(Stark anhaftendes Material).

## Accessories

### Upper suction heads in adiprene

(Strongly adherent material).

## Accesorios

### Tases-ventosas encima de adoprène

(Materia de gran adherencia).

Ø mm	No	gr.	Pce Fr.	Ø mm	No	gr.	Pce Fr.
16	5700-F	8		26	5700-J	13	
19	5700-G	9		30	5700-K	16	
22	5700-H	10		34	5700-L	19	

Assortiment de 6 tasseaux.  
Sortiment von 6 Stempeln.  
Assortment of 6 heads.  
Surtido de 6 tases.

No 5700-FL	121 gr.	Pce Fr.
------------	---------	---------



**Grands diamètres. Dur.**  
**Grosse Durchmesser. Hart.**  
**Big sizes. Hard.**  
**Grandes diámetros. Duro.**

Ø mm	No	gr.	Pce Fr.
40	5700-62-40	25	
45	5700-62-45	31	
50	5700-62-50	36	

### Tasseaux de base dessous, en adoprène avec hauteur réglable

### Untere Stempel aus Adipren mit einstellbarer Höhe

### Lower suction heads in adiprene with adjustable height

### Tases de base debajo adoprène con altura regulable



Assortiment de 3 tasseaux.  
Sortiment von 3 Stempeln.  
Assortment of 3 heads.  
Surtido de 3 tases.

No 5700-MP	100 gr.	Pce Fr.
------------	---------	---------



Ø mm	No	gr.	Pce Fr.
19	5700-M	9	
26	5700-N	13	
34	5700-P	19	

Tél. + 41 32 933 60 00  
Fax + 41 32 933 60 01

**B**  
**BERGEON**  
D e p u i s 1 7 9 1

www.bergeon.ch  
info@bergeon.ch

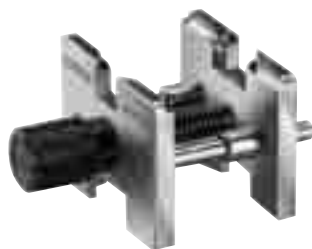

### Porte-pièce extensible et réversible

Pour calibres 3 3/4''' - 11''' . Nickelé et sablé.

### Dehn- und umkehrbarer Werkhalter

Für Kaliber 3 3/4''' - 11''' . Vernickelt und sandgestrahlt.

### Extensible and reversible movement holder

For calibres 3 3/4''' - 11''' . Nickelled and sanded.

### Porta-máquina extensible y reversible

Para calibres 3 3/4''' - 11''' . Niquelado y arenado.

 No 4039	32 gr.	Pce Fr.
---	--------	---------



### Porte-pièce extensible et réversible synthétique

Pour calibres 3 3/4''' - 11''' . Serrage sur Ø extérieur de 12 à 30 mm.

### Dehn- und umkehrbarer synthetischer Werkhalter

Für Kaliber 3 3/4''' - 11''' . Festklemmen auf Ø äußerlich von 12 bis 30 mm.

### Extensible and reversible synthetic movement holder

For calibres 3 3/4''' - 11''' . Tightening on Ø external from 12 to 30 mm.

### Porta-máquina extensible y reversible sintético

Para calibres 3 3/4''' - 11''' . Sujeción sobre Ø exterior de 12 a 30 mm.

 No 4039-P	13 gr.	Pce Fr.
---	--------	---------

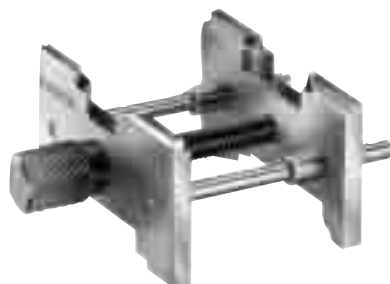

### Porte-pièce extensible et réversible

Pour calibres 8 3/4''' - 19''' . Nickelé et sablé.

### Dehn- und umkehrbarer Werkhalter

Für Kaliber 8 3/4''' - 19''' . Vernickelt und sandgestrahlt.

### Extensible and reversible movement holder

For calibres 8 3/4''' - 19''' . Nickelled and sanded.

### Porta-máquina extensible y reversible

Para calibres 8 3/4''' - 19''' . Niquelado y arenado.

 No 4040	40 gr.	Pce Fr.
---	--------	---------

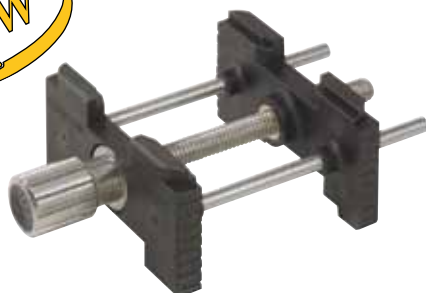

### Porte-pièce extensible et réversible synthétique

Pour calibres 8 3/4''' - 19''' . Serrage sur Ø extérieur de 30 à 48 mm.

### Dehn- und umkehrbarer synthetischer Werkhalter

Für Kaliber 8 3/4''' - 19''' . Festklemmen auf Ø äußerlich von 30 bis 48 mm.

### Extensible and reversible synthetic movement holder

For calibres 8 3/4''' - 19''' . Tightening on Ø external from 30 to 48 mm.

### Porta-máquina extensible y reversible sintético

Para calibres 8 3/4''' - 19''' . Sujeción sobre Ø exterior de 30 a 48 mm.

 No 4040-P	15 gr.	Pce Fr.
---	--------	---------

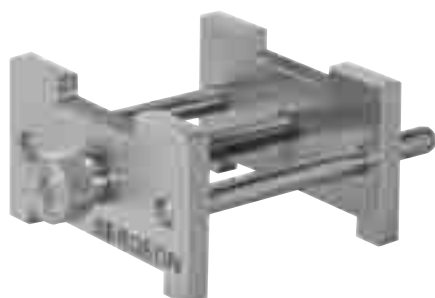

### Porte-pièce extensible et réversible

Pour montres de poche . Nickelé . Serrage sur Ø extérieur de 25 à 62 mm.

### Dehn- und umkehrbarer Werkhalter

Für Taschenuhren . Vernickelt . Festklemmen auf Ø äußerlich von 25 bis 62 mm.

### Extensible and reversible movement holder

For pocket watches . Nickelled . Tightening on Ø external from 25 to 62 mm.

### Porta-máquina extensible y reversible

Para relojes de bolsillo . Niquelado . Sujeción sobre Ø exterior de 25 a 62 mm.

 No 30211	145 gr.	Pce Fr.
--	---------	---------



www.bergeon.ch  
info@bergeon.ch

# BERGEON

Depuis 1791

Tél. + 41 32 933 60 00  
Fax + 41 32 933 60 01

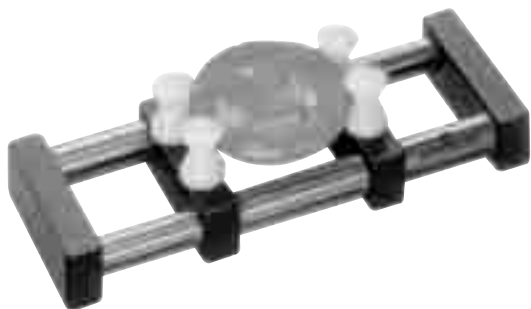

**Porte-module.** Chiens en plastique. Capacité Ø 36 mm.

**Modul-Halter.** Spannbacken aus Plastik. Kapazität Ø 36 mm.

**Module holder.** Chucks in plastic. Capacity Ø 36 mm.

**Porta módulo.** Mordazas de plástico. Capacidad Ø 36 mm.

 No 6515	55 gr.	Pce Fr.
---	--------	---------

### Porte-pièces

Laiton nickelé. Forme ronde.  
Dimension: Ø de base 31.0 mm.  
Autres modèles sur demande.

### Werkhalter

Messing vernickelt. Runde Form.  
Masse: Ø der Basis 31.0 mm.  
Andere Modelle auf Anfrage.

### Movements holder

Nickel-plated brass. Round shape.  
Dimension: base Ø 31.0 mm.  
Other models on request.

### Porta-máquinas

Latón niquelado. Forma redonda.  
Dimensión: Ø del base 31.0 mm.  
Otras modelos sobre demanda.



### Valjoux No 7750 13 1/4"

Avec 2 vis d'appui en acier trempé-revenu, 1 au centre et 1 à 12 h.  
2 boutons poussoirs 2 h. et 4 h. sans joint, ressort faible.

Mit 2 Stützschauben in gehärtetem, angelassenem Stahl, 1 im Zentrum, 1 bei 12 Uhr. 2 Druckknöpfe bei 2 und 4 Uhr ohne Dichtungsring, schwache Feder.

With 2 support screws in tempered steel, 1 at the center and 1 at 12 o'clock.  
2 pushers at 2 and 4 o'clock without gasket, weak spring.

Con 2 tornillos de apoyo en acero templado, 1 al centro y 1 a 12 h.  
2 pulsadores 2 h. y 4 h. sin guarnición, muelle débil.

No 1998	80 gr.	Pce Fr.
---------	--------	---------



### ETA 251.262 13 1/2"

Avec 4 vis d'appui en acier trempé-revenu et  
4 boutons poussoirs 2 h., 4 h., 8 h., 10 h.

Mit 4 Stützschauben in gehärtetem, angelassenem Stahl und  
4 Druckknöpfen bei 2, 4, 8, 10 Uhr.

With 4 support screws in tempered steel and  
4 pushers at 2, 4, 8 and 10 o'clock.

Con 4 tornillos de apoyo en acero templado y  
4 pulsadores a las 2 h., 4 h., 8 h., 10 h.

No 1996-251.262	80 gr.	Pce Fr.
-----------------	--------	---------



### ETA 2892-A 11 1/2" à 13 1/4"

Avec 4 vis d'appui en acier trempé-revenu et  
4 boutons poussoirs 4 h., 8 h., 10 h., 11 h.

Mit 4 Stützschauben in gehärtetem, angelassenem Stahl und  
4 Druckknöpfen bei 4, 8, 10 11 Uhr.

With 4 support screws in tempered steel and  
4 pushers at 4, 8, 10 and 11 o'clock.

Con 4 tornillos de apoyo en acero templado y  
4 pulsadores a las 4 h., 8 h., 10 h., 11 h.

No 1999	80 gr.	Pce Fr.
---------	--------	---------

### Porte-pièce de forme

Réversible. En laiton.  
Autres formes sur demande.  
Préciser le calibre.

### Formwerkhalter

Umkehrbar. Aus Messing.  
Andere Formen auf Anfrage.  
Kaliber angeben.

### Movement holder shaped

Reversible. In brass.  
Other shapes on request.  
Indicate the calibre.

### Porta-máquina de forma

Reversible. De latón.  
Otras formas sobre demanda.  
Indicar el calibre.



	No	Pce Fr.
3 3/4" x 6"	6706	
3 3/4" x 6 3/4"		
5 1/2" x 6 3/4"		
6 3/4" x 8		



# BERGEON

Depuis 1791

Tél. + 41 32 933 60 00

Fax + 41 32 933 60 01

www.bergeon.ch

info@bergeon.ch

## Porte-pièce réversible avec bouton

Forme ronde.  
Autres formes sur demande.  
Préciser le calibre.

## Umkehrbarer Werkhalter mit Knopf

Runde Form.  
Andere Formen auf Anfrage.  
Kaliber angeben.

## Reversible movement holders with knob

Round shape.  
Other shapes on request.  
Indicate the calibre.

## Porta-máquina treversibles con botón

Forma redonda.  
Otras formas sobre demanda.  
Indicar el calibre.



No 5914...







No 5914-P...





En laiton nickelé.  
Aus vernickeltes Messing.  
In nickelled brass.  
En latón niquelado.

En matière synthétique (PMMA).  
Aus synthetisches Material (PMMA).  
In synthetic matter (PMMA).  
En materia sintética.

	 gr.	Pce Fr.
4 1/4'''	9	
5'''	9	
5 1/4'''	9	
5 1/2'''	10	
5 3/4'''	10	
6'''	10	
6 1/2'''	10	
6 3/4'''	10	
7'''	10	
7 1/4'''	10	
7 1/2'''	10	
7 3/4'''	10	
8'''	10	
8 1/4'''	10	
8 3/4'''	10	

	 gr.	Pce Fr.
9'''	13	
9 1/4'''	13	
9 1/2'''	13	
9 3/4'''	13	
10 1/2'''	13	
10 3/4'''	13	
11'''	18	
11 1/4'''	18	
11 1/2'''	18	
11 3/4'''	18	
12'''	20	
12 1/4'''	20	
12 1/2'''	20	
12 3/4'''	20	
13'''	24	

	 gr.	Pce Fr.
13 1/4'''	13	
13 1/2'''	13	
13 3/4'''	13	
14'''	13	
14 1/2'''	13	
16'''	18	
16 1/2'''	18	
17'''	18	
18'''	18	
18 1/2'''	20	
19'''	20	
19 1/2'''	20	
22'''	20	

## Porte-pièces

Laiton nickelé. Forme ronde.  
Dimension: Ø de base 31.0 mm.  
Autres modèles sur demande.

## Werkhalter

Messing vernickelt. Runde Form.  
Masse: Ø der Basis 31.0 mm.  
Andere Modelle auf Anfrage.

## Movements holder

Nickel-plated brass. Round shape.  
Dimension: base Ø 31.0 mm.  
Other models on request.

## Porta-máquinas

Latón niquelado. Forma redonda.  
Dimensión: Ø del base 31.0 mm.  
Otras modelos sobre demanda.



## Valjoux No 7750 13 1/4'''

Modèle réversible, percé, avec bouton et 2 poussoirs 2 h. et 4 h.  
Reversible Modell, gebohrt, mit Druckknopf bei 2 und 4 Uhr  
Reversible model, drilled, with push button  
and 2 pushers at 2 and 4 o'clock.

Modelo reversible, perforados, con botón y 2 pulsadores 2 h. y 4 h.

No 5914-7750

90 gr.

Pce Fr.





# BERGEON

Depuis 1791

Tél. + 41 32 933 60 00  
Fax + 41 32 933 60 01

www.bergeon.ch  
info@bergeon.ch

## Réchaud à température variable réglée

Boîtier électronique avec affichage digital double.

Surface utile 63 x 113 mm.

Capacité de chauffe progressive et précise jusqu'à 180°C.

Mémorisation de 2 températures de consigne.

100 - 250 VAC. 50/60 Hz.

Câble silicone, résistant à la chaleur.

Témoin lumineux de chauffe.

## Heizplatte mit regulierbarer Temperatur

Elektronikgehäuse mit doppelt digitaler Anzeige.

Arbeitsfläche 63 x 113 mm.

Heizleistung progressif und präzise bis 180°C.

Speicherung für 2 Soll-Temperaturen.

100 - 250 VAC. 50/60 Hz.

Kabel Silikon, Hitzwiderstandsfähig.

Lampe für Heizungswarnungs.

## Electric heater with adjustable temperature

Electronic case with double digital display.

Working surface of 63 x 113 mm.

Progressive and accurate heating up to 180°C.

The heater can memorize 2 pre-set temperatures.

100 - 250 VAC. 50/60 Hz.

Cable silicone, resistant to heat.

Led for warning of heating.

## Estufa de temperatura variable

Caja electrónica con visualización digital multiple.

Superficie útil 63 x 113 mm.

Capacidad de calefacción progresiva de precisión hasta 180°C.

Memorización de 2 temperaturas de consigna.

100 - 250 VAC. 50/60 Hz.

Cable silicona resistente al calor.

Testigo luminescente de calefacción.

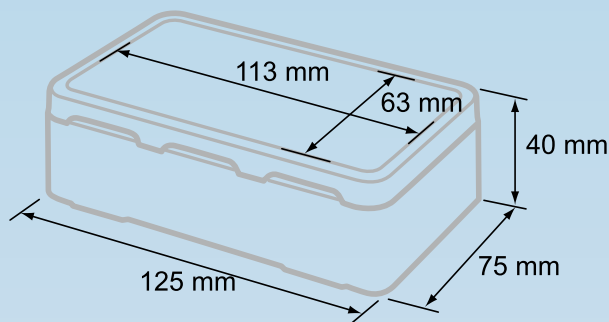

 SWISS MADE

No 7044

1.770 kg

Pce Fr.

## Réchaud à température variable réglée

Par potentiomètre.

100 - 250 VAC. 50/60 Hz.

## Heizplatte mit regulierbarer Temperatur

Durch regelbaren Spannungsleiter.

100 - 250 VAC. 50/60 Hz.

## Electric heater with adjustable temperature

By potentiometer.

100 - 250 VAC. 50/60 Hz.

## Estufa de temperatura variable

Por potenciómetro.

100 - 250 VAC. 50/60 Hz.

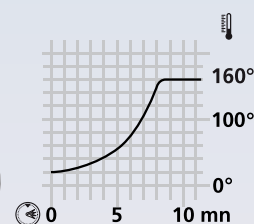

No 7044-V

377 gr.

Pce Fr.



# BERGEON

Depuis 1791

Tél. + 41 32 933 60 00  
Fax + 41 32 933 60 01

www.bergeon.ch  
info@bergeon.ch

## Brucelles recouvertes de Teflon

En acier. Pour l'électronique, l'horlogerie, etc.  
Grande précision et finesse.  
Pour la manutention des pièces microscopiques. Teinte verte.  
Antimagnétiques. Inoxydables.

## Kornzangen mit Teflon bedeckt

Aus Stahl. Für Elektronik, Uhrenindustrie, usw.  
Grosse Präzision und Feinheit.  
Zur Handhabung von mikroskopischen Teilen. Grün.  
Antimagnetisch. Rostfrei.

## Tweezers covered in Teflon

In steel. For electronics, watchmaking, etc.  
High precision and fine tips for handling of microscopic pieces.  
Green coloured.  
Anti-magnetic. Stainless.

## Pinzas recubiertas de Teflon

En acero. Para electrónica, o relojería, etc.  
Muy precisas y finas.  
Para manipular piezas microscópicas. Color verde.  
Antimagnéticas. Inoxidables.

Fines, soignées pour spiraux - Sehr fein für Spiralen  
Fine, excellent for hairsprings - Finas, para espirales



No 7029-3T	14 gr.	10 pces Fr.	Pce Fr.
------------	--------	-------------	---------

A mettre plat les aiguilles - Zum Flachrichten der Zeiger  
For flattening hands - Para aplanar minutos

No 7029-FT	15 gr.	10 pces Fr.	Pce Fr.
------------	--------	-------------	---------

## Brucelles aux verres

Nouvelle forme de brucelles, conçues spécialement pour saisir tous types de verres avec aisance.  
En acier inoxydable.  
Embouts de rechange en matière synthétique.  
Longueur: 120 mm.

## Kornzangen für Gläser

Neue Form der Kornzangen, speziell entwickelt, um alle Arten von Gläser mit Leichtigkeit zu erfassen.  
Aus Edelstahl.  
Ersatzspitzen aus synthetischem Material.  
Länge: 120 mm.

## Tweezers for glasses

New form of tweezers, specially designed to handle all types of glasses very easily.  
Stainless steel.  
Replacement tips of synthetic material.  
Length: 120 mm.

## Pinzas para lentes

Nueva forma de pinzas, especialmente diseñadas para manipular todo tipo de lentes con facilidad.  
En acero inoxidable.  
Puntas de recambio en materia sintética.  
Longitud: 120 mm.

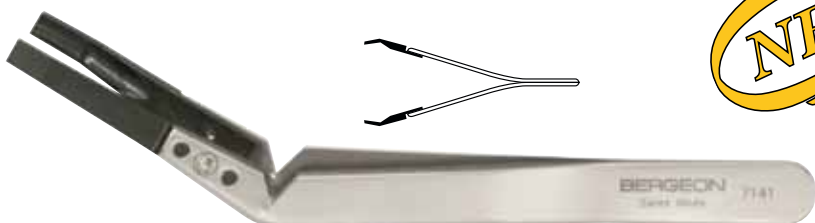

No 7141	16 gr.	Pce Fr.
---------	--------	---------

**Brucelles négatives.** Longueur: 120 mm.  
**Negative Kornzange.** Länge: 120 mm.  
**Negative tweezers.** Length: 120 mm.  
**Pinzas negativas.** Largo: 120 mm.

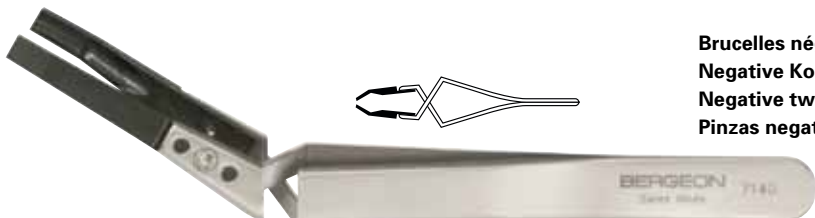

No 7140	16 gr.	Pce Fr.
---------	--------	---------

**Embouts de rechange en matière synthétique.** 1 paire.  
**Ersatzspitzen aus synthetischem Material.** 1 Paar.  
**Replacement tips of synthetic material.** 1 pair.  
**Puntas de replazo en materia sintética.** 1 par.



No 7140-BR	2.5 gr.	Pce Fr.
------------	---------	---------



# BERGEON

Depuis 1791

Tél. + 41 32 933 60 00  
Fax + 41 32 933 60 01

www.bergeon.ch  
info@bergeon.ch

**Assortiments de  
8 brucelles d'horlogerie**

**Sätze von 8 Kornzangen  
für die Uhrenindustrie**

**Sets of 8 tweezers  
for watch industry**

**Surtidos de  
8 pinzas de relojería**

 SWISS MADE

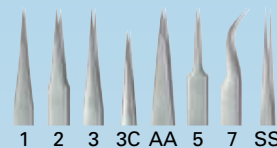

### Antimagnétiques

Très bonne résistance à la corrosion, aux produits acides et alcalins.

### Antimagnetisch

Sehr guter Widerstand auf Korrosion, Säuren und Alkali.

### Antimagnetics

Very good resistance to corrosion, acids and alkaline products.

### Antimagnéticos

Muy buena resistencia a la corrosión, a los productos ácidos y alcalinos.



No 7026

293 gr.

Pce Fr.



### Acier inoxydable

Magnétiques. Endurcies par traitement thermique, d'où des pointes très dures et fortes. Utilisées si une haute résistance à la corrosion n'est pas demandée.

### Edelstahl

Magnetisch. Gehärtet durch thermische Behandlung, daher sehr harte und starke Spitzen. Zu verwenden, wenn ein Korrosionswiderstand nicht gefragt ist.

### Stainless steel

Magnetics. Hardened by thermic treatment, therefore very hard and strong tips. Used if a high resistance to corrosion is not needed.

### Acero inoxidable

Magnéticos. Endurecidas por tratamiento térmico, de donde las puntas muy duras y fuertes. Utilizadas si una alta resistencia al corrosión non se pide.



No 7027

278 gr.

Pce Fr.



### Superalloy (Ni-Cr-Mo)

Très haute résistance thermique jusqu'à 800° C et six fois plus dure que l'acier inoxydable. 100% non-magnétique. Résistance à la corrosion, aux produits acides et alcalins.

### Superalloy (Ni-Cr-Mo)

Sehr hoher Temperaturwiderstand bis zu 800 Grad Celcius und sechsmal härter als Edelstahl. 100 % nicht magnetisch. Widerstand auf Korrosion, Säuren und Alkali.

### Superalloy (Ni-Cr-Mo)

Very high thermic resistance, up to 800°C and six times harder than stainless steel. 100% antimagnetic. Resistance to corrosion, acids and alkaline product.

### Superalloy (Ni-Cr-Mo)

Muy alta resistencia térmica asta 800° C y seis veces más duro que el acero inoxidable. 100% non magnético. Resistencia a la corrosión, a los productos ácidos y alcalinos.



No 7028

295 gr.

Pce Fr.



**Brucelles d'horlogerie**

**Uhrmacherkornzangen**

**Tweezers for watch industry**

**Pinzas de relojería**

**SWISS MADE**

120 mm



	Antimagnetic	<b>No 7026-1</b>	15 gr.	Pce Fr.
	Inox	<b>No 7027-1</b>	14 gr.	Pce Fr.
	Superalloy	<b>No 7028-1</b>	26 gr.	Pce Fr.

120 mm



	Antimagnetic	<b>No 7026-2</b>	16 gr.	Pce Fr.
	Inox	<b>No 7027-2</b>	15 gr.	Pce Fr.
	Superalloy	<b>No 7028-2</b>	28 gr.	Pce Fr.

120 mm



	Antimagnetic	<b>No 7026-3</b>	15 gr.	Pce Fr.
	Inox	<b>No 7027-3</b>	14 gr.	Pce Fr.
	Superalloy	<b>No 7028-3</b>	27 gr.	Pce Fr.

110 mm



	Antimagnetic	<b>No 7026-3C</b>	13 gr.	Pce Fr.
	Inox	<b>No 7027-3C</b>	12 gr.	Pce Fr.
	Superalloy	<b>No 7028-3C</b>	24 gr.	Pce Fr.

110 mm



	Antimagnetic	<b>No 7026-5</b>	14 gr.	Pce Fr.
	Inox	<b>No 7027-5</b>	13 gr.	Pce Fr.
	Superalloy	<b>No 7028-5</b>	25 gr.	Pce Fr.

115 mm



	Antimagnetic	<b>No 7026-7</b>	15 gr.	Pce Fr.
	Inox	<b>No 7027-7</b>	14 gr.	Pce Fr.
	Superalloy	<b>No 7028-7</b>	27 gr.	Pce Fr.

130 mm



	Antimagnetic	<b>No 7026-AA</b>	18 gr.	Pce Fr.
	Inox	<b>No 7027-AA</b>	17 gr.	Pce Fr.
	Superalloy	<b>No 7028-AA</b>	30 gr.	Pce Fr.

140 mm



	Antimagnetic	<b>No 7026-SS</b>	14 gr.	Pce Fr.
	Inox	<b>No 7027-SS</b>	13 gr.	Pce Fr.
	Superalloy	<b>No 7028-SS</b>	25 gr.	Pce Fr.

**Hors assortiment**

**Nicht im Sortiment**

**Not in assortment**

**No en el surtido**

120 mm



	Antimagnetic	<b>No 7026-00</b>	14 gr.	Pce Fr.
	Inox	<b>No 7027-00</b>	13 gr.	Pce Fr.
	Superalloy	<b>No 7028-00</b>	25 gr.	Pce Fr.

110 mm



	Antimagnetic	<b>No 7026-4</b>	14 gr.	Pce Fr.
	Inox	<b>No 7027-4</b>	13 gr.	Pce Fr.
	Superalloy	<b>No 7028-4</b>	25 gr.	Pce Fr.



# BERGEON

Depuis 1791

Tél. + 41 32 933 60 00  
Fax + 41 32 933 60 01

www.bergeon.ch  
info@bergeon.ch

## Flacon pour épilame

En verre.  
Pour utilisation des produits  
Moebius-Fixodrop No 8940, 8941,  
8950, 8951, planche 9186.

## Fläschchen für Epilame

Aus Glas.  
Für Benutzung der Produkte Moe-  
bius-Fixodrop Nr. 8940, 8941,  
8950, 8951, Seite 9186.

## Bottle for epilame

In glass.  
For use of the products Moebius-  
Fixodrop No 8940, 8941, 8950,  
8951, page 9186.

## Frasco para epilame

En vidrio.  
Para utilización los productos  
Moebius-Fixodrop No 8940, 8941,  
8950, 8951, página 9186.



No 7066

191 gr.

Pce Fr.

## Huile pour montres à quartz

Lubrifiant synthétique à champ  
d'application universel pour  
montres à quartz analogiques.  
Compatible avec les plastiques.  
Température d'emploi: -36° C.  
à + 80° C.  
Très bonne adhérence.  
Ne s'étale pas.  
S'utilise avec le pique-huile ou le  
huileur automatique.  
Contenu: 2 cm<sup>3</sup>.

## Oel für Quarzuhren

Synthetisches Schmiermittel,  
universelle Anwendung, für  
Analog-Quarzhren.  
Verträglich mit Kunststoffen.  
Anwendungstemperatur:  
von: -36° C. bis + 80° C.  
Sehr gute Haftung.  
Kein Breitleufen.  
Wird gebraucht mit Oelgeber  
oder automatischem Oeler.  
Inhalt: 2 cm<sup>3</sup>.

## Oil for quartz watches

Synthetic lubricant with a wide  
range of applications for analog  
quartz watches.  
Excellent compatibility with plastics.  
Working temperature: -36° C.  
à + 80° C.  
Very good adherence.  
Does not spread.  
To be applied by standard or  
automatic oilers.  
Contents: 2 cm<sup>3</sup>.

## Aceite para relojes de cuarzo

Lubricante sintético con un  
campo de aplicación universal  
para relojes de cuarzo analógicos.  
Compatible con los plásticos.  
Temperatura de empleo: -36° C.  
à + 80° C.  
Muy buena adherencia.  
No se desparrama.  
Se utiliza con un pica aceite o un  
aceitador automático.  
Contenido: 2 cm<sup>3</sup>.



No 9000

10 gr.

Dz Fr.

Pce Fr.







www.bergeon.ch  
info@bergeon.ch

# BERGEON

Depuis 1791

Tél. + 41 32 933 60 00  
Fax + 41 32 933 60 01

Emploi Verwendung Application Uso	Observations Bemerkungen Observations Observaciones	 cm <sup>3</sup>	 gr.	No	Pce Fr.
<b>8513</b> Graisse silicone d'étanchéité, qualité normale. Silikon-Dichtungsfett. Normalqualität. Silicone insulation grease. Normal grade. Grasa silicona de hermeticidad, calidad normal.		10	15	<b>8513-10</b>	
		50	70	<b>8513-50</b>	
		100	145	<b>8513-100</b>	
		200	320	<b>8513-200</b>	
		1000	1450	<b>8513-1000</b>	
<b>8514</b> <b>Graisse synthétique CH.</b> Pour instruments de mécanique de précision et d'optique. Bonne résistance à la chaleur. <b>Synthetisches Fett.</b> Für Feinmechanik und Optik. Hitzebeständig. <b>Synthetic grease.</b> For fine mechanisms and optics. Heat resistant. <b>Grasa sintética CH.</b> Para instrumentos de mecánica de precisión y de óptica. Buena resistencia al calor.		10	40	<b>8514-10</b>	
		50	80	<b>8514-50</b>	
<b>8516</b> Graisse silicone d'étanchéité, qualité molle. Silikon-Dichtungsfett. Weiche Qualität. Silicone insulation grease. Soft grade. Grasa silicona de hermeticidad, calidad blanda.		10	15	<b>8516-10</b>	
		50	72	<b>8516-50</b>	
		200	550	<b>8516-200</b>	



Emploi Verwendung Application Uso	Observations Bemerkungen Observations Observaciones	 cm <sup>3</sup>	 gr.	No	Pce Fr.
<b>8950 FIXODROP FK/K</b> <b>Solution concentrée.</b> Pour le traitement du plastique. <b>Konzentrierte Lösung.</b> Für die Behandlung von Plastik. <b>Concentrated solution.</b> For the treatment of plastics. <b>Solución concentrada.</b> Para el tratamiento del plástico.		100	320	<b>8950-100</b>	
		250	800	<b>8950-250</b>	
		1000	2360	<b>8950-1000</b>	
<b>8951 FIXODROP FK/K10</b> <b>Solution prête à l'emploi.</b> Pour le traitement du plastique. <b>Gebrauchsfertige Lösung.</b> Für die Behandlung von Plastik. <b>Ready-to-use solution.</b> For the treatment of plastics. <b>Solución dispuesta para el uso.</b> Para el tratamiento del plástico.		100	320	<b>8951-100</b>	
		250	800	<b>8951-250</b>	
		1000	2360	<b>8951-1000</b>	
<b>8940 FIXODROP FK/BS</b> <b>Solution concentrée.</b> Contient 10 x plus de produit actif que le No 8941 FK/BS10. Diluer uniquement avec le produit: TETRADECAFLUROHEXANE. Pour le traitement des rubis ainsi que pour l'acier, le laiton et autres métaux. <b>Konzentrierte lösung.</b> Enthält 10 Mal mehr des aktiven Produktes als die Nr. 8941 FK/BS10. Ist nur mit dem Produkt: TETRADECAFLUROHEXANE zu verdünnen. Zur Behandlung von Rubin, sowie für Stahl, Messing und andere Metalle. <b>Concentrated solution.</b> Contains 10 times more of actif product than No Nr. 8941 FK/BS10. Dilute only with: TETRADECAFLUROHEXANE. For the treatment of ruby as well as steel, brass and other metals. <b>Solución concentrada.</b> Contiene 10 veces más producto activo que el No 8941 FK/BS10. Diluir únicamente con el producto: TETRADECAFLUROHEXANE. Para el tratamiento de los rubis, así como el acero, el latón y otros metales.		100	320	<b>8940-100</b>	
		1000	2360	<b>8940-1000</b>	
<b>8941 FIXODROP FK/BS10</b> <b>Solution prête à l'emploi.</b> Pour le traitement des rubis ainsi que pour l'acier, le laiton et autres métaux. <b>Gebrauchsfertige Lösung.</b> Zur Behandlung von Rubin, sowie für Stahl, Messing und andere Metalle. <b>Ready-to-use solution.</b> For the treatment of ruby as well as steel, brass and other metals. <b>Solución dispuesta para el uso.</b> Para el tratamiento de los rubis, así como el acero, el latón y otros metales.		100	320	<b>8941-100</b>	
		250	800	<b>8941-250</b>	
		1000	2360	<b>8941-1000</b>	

**MOEBIUS**  
member of  
**SWATCH GROUP**

### Epilame

Destiné aux traitements de surfaces pour éviter l'étalement de certaines huiles.

### Epilame

Für die Vorbehandlung von Oberflächen zur Verhinderung des Breitleaufens von Öl.

### Epilame

For the use in surface treatment to prevent the spreading of oil.

### Epilame

Destinado a tratamiento de superficies para evitar el esparcimiento de ciertos aceites.





# BERGEON

Depuis 1791

Tél. + 41 32 933 60 00  
Fax + 41 32 933 60 01

www.bergeon.ch  
info@bergeon.ch

## Tissus pour un environnement à atmosphère contrôlée (salle blanche) Gewebe für Umwelt in der geprüften Atmosphäre (Reinraum) Wipers for environment in controlled atmosphere (clean room) Tejidos para medio ambiente con atmósfera controlada (sala blanca)

### Tissus cellulose/polyester

Spécialement adapté pour l'essuyage en général, pour petites et grandes surfaces.

#### Propriétés:

- non contaminant
- ne relargue pas de fibres
- jetable
- très absorbant.

#### Conditionnement:

**7037-100** livré par paquet de 1200 pièces  
**7037-230** livré par paquet de 300 pièces.

### Gewebe aus Zellstoff/Polyester

Besonders geeignet zum Abtrocknen, von kleinen und großen Oberflächen.

#### Eigenschaften:

- Nicht ansteckend
- Fuselfrei
- Wegwerfbar
- Grosse Saugkraft.

#### Verpackung:

**7037-100** Pakete zu 1200 Stück  
**7037-230** Pakete zu 300 Stück.

### Wipers Cellulose/Polyester

Especially adapted for wiping in general, for small and big surfaces.

#### Properties:

- Not contaminant
- Do not reject fibres
- Disposable
- Highly absorbent.

#### Packaging:

**7037-100** delivered by package of 1200 pieces  
**7037-230** delivered by package of 300 pieces.

### Tejidos celulosa/poliéster

Especialmente adaptado para limpieza de las superficies pequeñas y grandes.

#### Propiedades:

- No contaminan
- no se deshilachan
- desechable
- muy absorbente.

#### Acondicionamiento.

**7037-100** entregado por paquete de 1200 piezas  
**7037-230** entregado por paquete de 300 piezas.



100 x 100 mm	<b>No 7037-100</b>	1106 gr.	Pce Fr.
230 x 230 mm	<b>No 7037-230</b>	1180 gr.	Pce Fr.

### Tissus 100% polyester

Tissus lavé à l'eau déionisée, ultra-propre, pour salles blanches, catégorie ISO3.

#### Propriétés:

- non-contaminant
- ne relargue pas de fibres
- jetable
- moyennement absorbant.

**Conditionnement:** livré par paquet de 150 pièces.

### Gewebe 100% Polyester

In entionisiertem Wasser gewaschenes Gewebe ultrasauber, für Reinräume, Kategorie ISO3.

#### Eigenschaften:

- Nicht ansteckend
- Fuselfrei
- Wegwerfbar
- Mittelmässige Saugkraft.

**Verpackung:** Pakete zu 150 Stück.

### Wipers 100% Polyester

Wipers washed with deionised water, ultra-clean, for white rooms, category ISO3.

#### Properties:

- Not contaminant
- Do not reject fibres
- Disposable
- Fairly absorbent.

**Packaging:** Delivered by package of 150 pieces.

### Tejido 100% poliéster

Lavados al agua desmineralizada, ultralimpia, para salas blancas, categoría ISO3.

#### Propiedades:

- No contaminan
- no se dishalachan
- desechable
- bastante absorbente.

**Acondicionamiento:** entregado por paquete de 150 piezas.



230 x 230 mm	<b>No 7038</b>	590 gr.	Pce Fr.
--------------	----------------	---------	---------



# BERGEON

Depuis 1791

www.bergeon.ch  
info@bergeon.ch

Tél. + 41 32 933 60 00  
Fax + 41 32 933 60 01

## Tissus 100% microfibre

Recommandé spécialement pour l'essuyage des pièces ou composants en or très sensibles aux rayures ainsi que verres de montres avec anti-reflet.

### Propriétés:

- lavable à 40° C.
- non-contaminant
- ne relargue pas de fibres.

**Conditionnement:** livré par paquet de 100 pièce

## Gewebe 100% Mikrofaser

Besonders zum Abtrocknen von Gold Stücken kratzempfindlichen, sowie Antireflex Uhrgläsern.

### Eigenschaften:

- Bei 40°C waschbar
- Fuselfrei
- Nicht ansteckend.

**Verpackung:** Pakete zu 100 Stück

## Wipers 100% Microfibre

Especially recommended for the wiping of gold item or component highly sensitive to scratches as well as anti-reflecting watch glasses.

### Properties:

- Washable at 40°C
- Not contaminant
- Do not reject fibres.

**Packaging:** Delivered by package of 100 pieces

## Tejido 100% microfibra

Recomendado especialmente para el pulido de las piezas o los componentes de oro muy sensibles a las rayas así como los cristales de reloj con antireflejo.

### Propiedades:

- Lavable a 40 ° C.
- No contaminan
- no se deshilachan.

**Acondicionamiento:** entregado por paquete de 100 piezas.



230 x 230 mm **No 7039** 786 gr. Pce Fr.

## Tissus polypropylène

Pour tout nettoyage de pièces ou surfaces grasses, imbibé de 70% isopropyl, 30% eau déionisée.

### Propriétés:

- fort pouvoir dégraissant.
- tissu propre, pour cat. ISO3
- ne relargue pas de fibres
- jetable.

### Conditionnement:

livré par sachet de 50 pièces.

## Gewebe Polypropylene

Für jegliche Reinigung von fettigen Teilen oder Oberflächen.

Mit 70% Isopropyl und 30% deionisiertem Wasser angereichert.

### Eigenschaften:

- Stark entfettend
- Sauberes Gewebe, für Kat. ISO3
- Fuselfrei
- Wegwerfbar.

**Verpackung:** Pakete zu 50 Stück.

## Wipers Polypropylene

For cleaning of greasy piece surfaces, soaked with 70% isopropyl, 30% of deionised water.

### Properties:

- Strong grease-removing capacity
- Clean tissue for cat. ISO3
- Do not reject fibres
- Disposable.

**Packaging:** Delivered by package of 50 pieces.

## Toallitas polipropileno

Para toda la limpieza de las piezas o superficies grasas, prehumedecidas con 70% alcohol isopropilico y 30% agua desmineralizada.

### Propiedades:

- fuerte poder desengrasante
- Tejido limpio, para cat. ISO3
- no se deshilacha
- desechable.

**Acondicionamiento:** entregadas por paquete de 50 piezas.



230 x 280 mm **No 7040** 455 gr. Pce Fr.



230 x 280 mm **No 7040-2** 455 gr. Pce Fr.



## Sticks de nettoyage

### Avantages:

- Nouvelle qualité.
- Matière et structure des têtes, idéales pour tous travaux de nettoyages.
- Ne s'effilochent pas.



## Reinigungsstäbchen

### Vorteile:

- Neue Qualität.
- Material und Struktur der Spitzen ideal für alle Reinigungsarbeiten.
- Es Fasert nicht.

## Swabs for cleaning

### Advantages:

- New quality.
- Material and structure, of the tips, ideal for all cleaning work.
- Does not fringe.

## Bastoncillos de limpieza

### Ventajas:

- Nueva calidad.
- Materia y estructura, de las cabezas, ideales para todos los trabajos de limpiezas.
- No se hilacha.

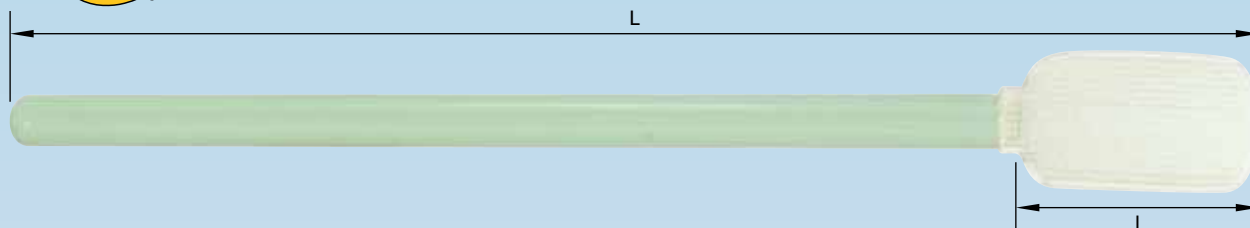

Matière Material Material Materia	L mm	l mm	No	Forme Form Shape Forma	
Polyester thermosoudé Polyester thermo geschweisst Polyester thermally bonded Polyester thermo soldado	90	15	7007-08		100 pces / Fr.
	120	22	7007-09		100 pces / Fr.
	165	16	7007-10		100 pces / Fr.
	73	14	7007-12		500 pces / Fr.
	70	10	7007-13		500 pces / Fr.
	70	12	7007-14		500 pces / Fr.
Mousse polyuréthane thermosoudée Polyurethanschaum thermo geschweisst Foam Polyurethane thermally bonded Esponja de polyuretano thermo soldada	65	15	7007-11		500 pces / Fr.
	76	11	7007-15		500 pces / Fr.
	70	11	7007-16		500 pces / Fr.
	130	22	7007-17		50 pces / Fr.
Microfibre thermosoudée Microfiber thermo geschweisst Microfibre thermally bonded Microfibra thermo sodada	147	20	7007-18		125 pces / Fr.
Mousse caoutchouc et polyuréthane inséré Schaum- Rubber und Polyurethan einsatz Foam rubber and polyurethane insert Esponja de caucho y polyuretano inserido	85	17	7007-19		100 pces / Fr.



# BERGEON

Depuis 1791

Tél. + 41 32 933 60 00  
Fax + 41 32 933 60 01

www.bergeon.ch  
info@bergeon.ch

## Blouse d'horloger antistatique

Trois poches, double col, fermeture avec boutons pression, cache-boutons pour ne pas endommager les établis, poignets réglables avec boutons pression.

Tissu mixte: 70% polyester, 28% coton et 2% carbone.

Très légères et confortables, couleur blanche quadrillée avec trames de carbone.

Logo brodé sur demande.



## Uhrmacherkittel antistatisch

3 Taschen, doppel Kragen, Druckknopfverschluss, Knöpfe verdeckt damit der Arbeitstisch nicht beschädigt wird, Manschetten mit Drücker regulierbar.

Gewebe aus: 70% Polyester, 28% Baumwolle und 2% Kohlenstoff. Sehr leicht und konfortabel, Farben weiss mit dunklen Streifen.

Auf Wunsch mit gesticktem Logo.

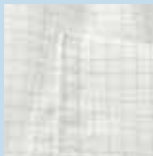

Tailles  
Grössen  
Sizes  
Tallas  
XXS-XS-S-M-L-XL-XXL

## Antistatic coat for watchmaker

Three pockets, double collar, pressure buttons, masked buttons in order to protect the workbenches, adjustable wrists with pressure buttons.

Mixed fabrics: 70% polyester, 28% cotton and 2% carbon.

Very light and comfortable, white color with wefts of carbon. Embroidered Logo on demand.

## Batas de relojero antiestáticas

Tres bolsillos, cuello camisa, cierre mediante corchetes, solapa para protección del puesto de trabajo, ajuste de mangas con corchetes. Tejido mixto de 70% poliéster, 28% algodón y 2% carbono.

Muy ligeras y confortables, color blanco con cuadrados de carbono. Logotipo bordado posible.

○	BERGEON ○	gr.	Pce Fr.
7184-W XXS	7084-W XXS	335	
7184-W XS	7084-W XS	340	
7184-W S	7084-W S	345	
7184-W M	7084-W M	350	
7184-W L	7084-W L	355	
7184-W XL	7084-W XL	360	
7184-W XXL	7084-W XXL	365	

## Blouse antistatique jetable

Pour visiteurs. Avec 2 poches. Col chemise, poignets avec élastique. Fermeture avec boutons pression.

## Antistatische Kittel wegwerfbar

Für Besucher. Mit 2 Taschen. Hemdkragen, Manschetten mit Gummizug. Verschluss mit Druckknöpfen.

## Antistatic lab coats disposable

For visitors. With 2 pockets. Shirt collar, cuffs with elastic. Closure with snaps.

## Batas desechables antiestáticas

Para visitantes. Con dos bolsillos. Cuello camisa, puños con elástico. Cierre con corchetes.



No 7185-L 8.5 kg  50x Pce Fr.

No 7185-XL 8.5 kg  50x Pce Fr.

## Blouse de travail

Pour horlogers, bijoutiers. 3 poches, poche de poitrine avec compartiments pour crayons. 3 boutons à pression.

Tissu mixte: 65% polyester, 35% coton. Couleur blanche ou bleu ciel.

## Arbeitskittel

Für Uhrmacher und Juweliere. 3 Taschen, Brusttasche mit abgesteppten Bleistiftfächern. 3 Druckknöpfe.

Mischgewebe: 65% Polyester, 35% Baumwolle. Farbe: weiss oder Himmelblau.



## Overall

For watchmakers and jewellers. 3 pockets, breast pocket stitched in divisions for pencils. 3 press buttons heat fixed. Mixed material: 65% polyester, 35% cotton. Colour: white or clear blue.

## Bata de trabajo

Para relojeros, joyeros. 3 bolsillos, bolsillo de pecho con divisiones para lapiceros. 3 botones a presión. Tejido mixto: 65% polyester, 35% algodón. Color: blanco o azul claro.



 -cm	○	BERGEON ●	 gr.	Pce Fr.
84	5983-42	7084-B XXS	410	
88	5983-44	7084-W XXS	420	
92	5983-46	7084-B XS	430	
96	5983-48	7084-B S	440	
100	5983-50	7084-B M	450	
104	5983-52	7084-B L	460	
108	5983-54	7084-B XL	470	
112	5983-56	7084-B XXL	480	





# BERGEON

Depuis 1791

Tél. + 41 32 933 60 00  
Fax + 41 32 933 60 01

www.bergeon.ch  
info@bergeon.ch

## Mallette d'outils pour le rhabillage et le SAV

En cuir très soigné.  
**Contient:** 42 outils et accessoires  
spécialisés.

## Werkzeugtasche für die Reparatur und den Nachverkaufs-Service

Aus sorgfältigem Leder.  
**Enthält:** 42 Werkzeuge  
und spezielle Zubehörteile.

## Tools kit for watchmaking after-sale service

Very carefully made leather case.  
**Contents:** 42 specialized tools  
and accessories.

## Estuche de herramientas para reparaciones y para taller de composturas

En cuero esmerado.  
**Contiene:** 42 herramientas  
y accesorios específicos.



No 6817-09

1.900 Kg

Pce Fr.

<b>No 7026-1/5</b>  <b>No 8082-B</b> 	Brucelles Kornzangen Tweezers Pinzas				Ass.d'équarrissoirs Sort. Reibahlen Ass. cutting broaches Sur. escaridados <b>No 1896-G</b>  7103-A <b>No 4040-P</b>  7103-A
<b>No 7026-F</b>  <b>No 8082-C</b> 	Brucelles Kornzangen Tweezers Pinzas				Porte-pièces Werkhalter Mouvement holder Porta máquinas <b>No 9010-2</b>  9181
<b>No 5394-PG</b>  <b>7060-A</b> 	Coussin d'emboitage: Ø 80 mm Einschalungskissen: Ø 80 mm Casing cushion: Ø 80 mm Almohadilla-apoyo: Ø 80 mm				Huile synthétique "Moebius" Flasche mit Oel "Moebius" Bottle synthetic "Moebius" Botellita de aceite "Moebius" <b>No 30102-4</b>  7016-M
<b>No 2834-C</b>  <b>4106-D</b> 	Gratte-brosses Kratzbürste Scratch-brush Grata hilo				Ass. piques-huile Sort. Oelgeber Ass. oilers Sur. pica-acite <b>No 30081-...</b>  <b>8000-C/E</b> 
<b>No 30081-...</b>  <b>8000-C/E</b> 	9 Tournevis: Ø 0.50-2.50 mm 9 Schraubenzieher: Ø 0.50-2.50 mm 9 Screwdrivers: Ø 0.50-2.50 mm 9 Destornilladores: Ø 0.50-2.50 mm				<b>No 30081-T</b>  <b>8000-D</b> 
<b>No 30081-T</b>  <b>8000-D</b> 	5 Tubes de mèches de recharge: Ø 0.50-1.20 mm 5 Tuben Ersatzklingen: Ø 0.50-1.20 mm 5 Tubes with spare blades: Ø 0.50-1.20 mm 5 Tubos de mechas de recambio: Ø 0.50-1.20 mm				Pierre India India-Stein "INDIA" stone Piedra India <b>No 6767-S</b>  <b>7007-G</b> 
<b>No 6767-S</b>  <b>7007-G</b> 	Outil aux barrettes Federstege-Werkzeug Spring-bars tool Sacapasadores				Support pour cadran Träger für Zifferblätter Base for dialplates Zocaló para esferas <b>No 30019</b>  <b>7050</b> 
<b>No 30019</b>  <b>7050</b> 	2 Leviers fins pour aiguilles 2 Feine Hebel für Zeiger 2 Fine hands-levers 2 Palanquitas finas para agujas				Microscope Lupe Loupe Lupa <b>No 7404-1</b>  <b>7056-A</b> 
<b>No 7404-1</b>  <b>7056-A</b> 	Outil à poser les aiguilles Werkzeug zum Zeigersetzen Hands setting tool Útil para colocar las agujas				Microscope Lupe Loupe Lupa <b>No 7404-2</b>  <b>7056-A</b> 
<b>No 7404-2</b>  <b>7056-A</b> 	Outil à poser les aiguilles Werkzeug zum Zeigersetzen Hands setting tool Útil para colocar las agujas				"RODICO PREMIUM" "RODICO PREMIUM" "RODICO PREMIUM" "RODICO PREMIUM" <b>No 7404-3</b>  <b>7056-A</b> 
<b>No 7404-3</b>  <b>7056-A</b> 	Canif et ouvre-boîtes Messer mit Gehäuseöffner Knife and case opener Navajitas y abre cajas				Microfibre "Micro-Clair" Mikrofaser "Micro-Clair" "Micro-Clair" micro fibres Microfibra "Micro-Clair" <b>No 6403</b>  <b>7007-J6</b> 
<b>No 6403</b>  <b>7007-J6</b> 	Canif et ouvre-boîtes Messer mit Gehäuseöffner Knife and case opener Navajitas y abre cajas				Microfibre "Micro-Clair" Mikrofaser "Micro-Clair" "Micro-Clair" micro fibres Microfibra "Micro-Clair" <b>No 1282-D</b>  <b>4106-E</b> 
<b>No 1282-D</b>  <b>4106-E</b> 	Cabron de peau + protège cabron 4056-6 Lederfeile + Lederfeilenschutz 4056-6 Leather buff + buffs protector 4056-6 Pulidor en piel + protección 4056-6				3 Tubes 3 Tuben 3 Tubes 3 Tubos <b>No 6460-P</b>  <b>8078</b> 
<b>No 6460-P</b>  <b>8078</b> 	Brucelles en plastique Plastik-Kornzangen Plastic tweezers Pinzas plásticas				3 Tubes 3 Tuben 3 Tubes 3 Tubos <b>No 30636-1</b>  <b>7051</b> 
<b>No 30636-1</b>  <b>7051</b> 	Outil "PRESTO" "PRESTO" Werkzeug "PRESTO" tools "PRESTO" herramienta				Contenu: 42 outils et accessoires spécialisés. Inhalt: 42 Werkzeuge und spezielle Zubehörteile. Contents: 42 specialized tools and accessories. Contenido: 42 herramientas y accesorios específicos.



Tél. + 41 32 933 60 00  
Fax + 41 32 933 60 01

# BERGEON

www.bergeon.ch  
info@bergeon.ch

by Smile Line ☺

### Version 1

Comprenant les tiroirs T01 - T03 - T04 - T06 - T08 - T09.

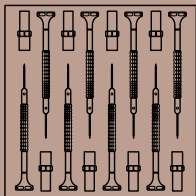

### Version 1

Erfasst die Schubladen T01 - T03 - T04 - T06 - T08 - T09.

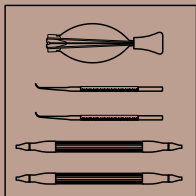

### Version 1

Including the drawers T01 - T03 - T04 - T06 - T08 - T09.

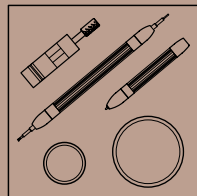

### Versión 1

Incluyendo los cajones T01 - T03 - T04 - T06 - T08 - T09.

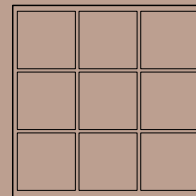
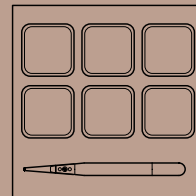

● **No 7014-N-V1** 2.390 kg Pce Fr.

● **No 7014-G-V1** 2.390 kg Pce Fr.



### Version 2

Comprenant les tiroirs 3 x T09 et 3 x T10.

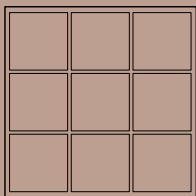

### Version 2

Erfasst die Schubladen 3 x T09 und 3 x T10.

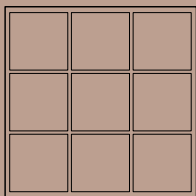

### Version 2

Including the drawers 3 x T09 and 3 x T10.

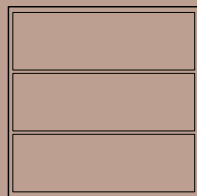

### Versión 2

Incluyendo los cajones 3 x T09 y 3 x T10.



● **No 7014-N-V2** 2.050 kg Pce Fr.

● **No 7014-G-V2** 2.050 kg Pce Fr.



**BERGEON**

by Smile Line ☺

www.bergeon.ch  
info@bergeon.ch

Tél. + 41 32 933 60 00  
Fax + 41 32 933 60 01



Tiroir noir, mousse noire - Schwarze Schublade, schwarzer Schaum  
Black drawer, black foam - Cajón negro, espuma negra.

Tiroir gris, mousse noire - Graue Schublade, schwarzer Schaum  
Gray drawer, black foam - Cajón gris, espuma negra.



 **No 7014-N-T01** 220 gr. Pce Fr.



 **No 7014-G-T01** 220 gr. Pce Fr.

 **No 6899-...** - Ø 0.50, 0.60, 0.80, 1.00, 1.20, 1.40, 1.60, 2.00 mm.  
 **No 6899-T-...** - Ø 0.50, 0.60, 0.80, 1.00, 1.20, 1.40, 1.60, 2.00 mm.



 **No 7014-N-T02** 240 gr. Pce Fr.

 **No 7014-G-T02** 240 gr. Pce Fr.





 **No 6988-...** - Ø 0.70, 0.80, 0.90, 1.00, 1.20 mm.  
 **No 30080-T-...** - Ø 0.70, 0.80, 0.90, 1.00, 1.20 mm.

 **No 30106-D** -  **No 4000**





 **No 7014-N-T03** 230 gr. Pce Fr.



 **No 7014-G-T03** 230 gr. Pce Fr.

 **No 30636-1**  **No 7050-601-1**  
 **No 30018 (2 x)**  **No 7050-601-2**



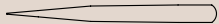
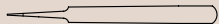

 **No 7014-N-T04** 240 gr. Pce Fr.



 **No 7014-G-T04** 240 gr. Pce Fr.

 **No 7026-1 - 7026-2 - 7026-3 - 7026-5**  
 **No 7026-F** -  **No 6571-E**



 **No 7014-N-T05** 200 gr. Pce Fr.

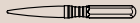

 **No 7014-G-T05** 200 gr. Pce Fr.

 **No 7013-...** - Ø 0.18, 0.24, 0.32, 0.45 mm. -  **No 6885-...** - Ø 6, 8, 10, 12 mm.





 **No 7014-N-T06** 320 gr. Pce Fr.



 **No 7014-G-T06** 320 gr. Pce Fr.

 **No 5394-P** -  **No 4721** -  **No 6876**  
 **No 7050-604**  **No 7050-602-S**



 **No 7014-N-T07** 240 gr. Pce Fr.



 **No 7014-G-T07** 240 gr. Pce Fr.

 **No 6901-TBPR-120**  
 **No 6901-AR-...** &  **No 6895-...** Ø 0.50, 0.60, 0.80, 1.00, 1.20, 1.40, 1.60, 2.00 mm.



 **No 7014-N-T08** 210 gr. Pce Fr.

 **No 7014-G-T08** 210 gr. Pce Fr.

 **No 6571-E** -  **No 6799-01 (6 x)**



 **No 7014-N-T09** 180 gr. Pce Fr.

 **No 7014-G-T09** 180 gr. Pce Fr.

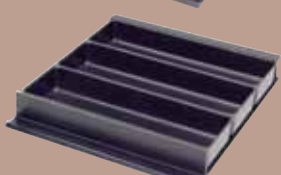

 **No 7014-N-T10** 180 gr. Pce Fr.

 **No 7014-G-T10** 180 gr. Pce Fr.



Tél. + 41 32 933 60 00  
Fax + 41 32 933 60 01

**B**  
**BERGEON**

www.bergeon.ch  
info@bergeon.ch

by Smile Line ☺



### The Cube

Layette de table en aluminium avec 5 tiroirs garnis pour le rhabillage.

Schubladenstock bestückt mit 5 Schubladen für Uhrenreparatur.

Aluminium Cube with 5 furnished drawers. For repairing.

"Layette" mueble con cajones en aluminio con 5 cajones surtidos para la compostura.

No 7014-G-V3	2.700 kg	Pce Fr.
--------------	----------	---------

**PREMIUM**

#### Tiroir gris, mousse noire





#### Graue Schublade, schwarzer Schaum





#### Gray drawer, black foam

#### Cajón gris, espuma negra

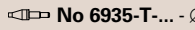
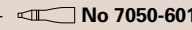
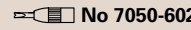

No 7014-G-T11	270 gr.	Pce Fr.
---------------	---------	---------

 No 7062 - Ø 5 mm -  No 7063-T... - Ø 0.50, 0.60, 0.80, 1.00, 1.20, 1.40, 1.60, 2.00 mm.  
 No 7063 - Ø 9 mm -  No 7063-... - Ø 0.50, 0.60, 0.80, 1.00, 1.20, 1.40, 1.60, 2.00 mm.



No 7014-G-T12	260 gr.	Pce Fr.
---------------	---------	---------

 No 7027-1, 7027-3, 7027-5 -  No 7050-611  
 No 6935-T... - Ø 0.60, 1.20, 1.50, 1.60 mm. -  No 7050-601-01 -  No 7050-602-01  
 No 7050-612 -  No 7050-610

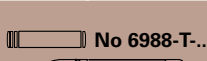
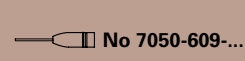

No 7014-G-T13	490 gr.	Pce Fr.
---------------	---------	---------

 No 7060 - Ø 0.60, 0.80, 0.90, 1.00 mm. -  No 7061-... - Ø 0.18, 0.24, 0.32, 0.45 mm.

No 7014-G-T14	310 gr.	Pce Fr.
---------------	---------	---------

 No 5935 -  No 6988-T... - Ø 0.70, 0.80, 0.90, 1.00, 1.20 mm. -  No 7050-609-...  
 No 7050-60

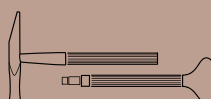
No 7014-G-T15	380 gr.	Pce Fr.
---------------	---------	---------

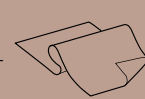
 No 1442 -  No 7857 -  No 6850-2-JS





**Lanières en cuir  
pour le transport**

**Schmale Riemen aus  
Leder für den Transport**

**Leather thin straps  
for transport**

**Correas de cuero  
para el transporte**



No 7014-L1

190 gr.

Pce Fr.



No 7014-L2

157 gr.

Pce Fr.

**Chaise ergonomique d'horloger**

Siège et dossier pivotants en bois, rembourrage en tissu.

**Piètement à 5 branches en aluminium poli.**

Hauteur, réglable de 43 à 59 cm par système à gaz au moyen d'un levier. Dossier réglable séparément.

**Ergonomischem Stuhl für Uhrmacher**

Drehbarer Sitz und Rückenlehne aus Holz, Polsterung aus Stoff.

**Mit 5 armigen Füßen aus poliertem Aluminium.**

Regulierbare Höhe von 39 bis 59 cm durch einem Gas-System mit einem Hebel. Rückenlehne separat regulierbar.

**Ergonomic chair to watchmaker**

Rotative seat and back made of wood, upholstery cloth.

**On 5 branch pedestal in polished aluminium.**

Height adjustable from 43 to 59 cm by gas system with the help of a lever. Back adjustable separately.

**Silla ergonómica de relojero**

Asiento giratorio y respaldo de madera y tela.

**Base con 5 ramas de aluminio pulido.**

Altura regulable de 43 a 59 cm por sistema de gas, con palanca. Respaldo ajustable separadamente.

No 7172

12 kg

Pce Fr./10

Pce Fr.

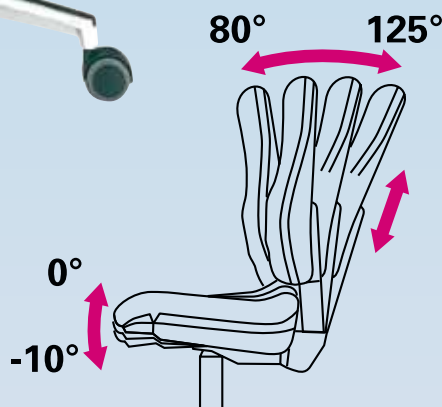
**Chaise ergonomique de bijoutier**Coque extérieure en polyamide noir. Garniture en matière synthétique (polyuréthane). **Piètement à 5 branches en polyamide noire.**

Hauteur, réglable de 40 à 56 cm par système à gaz au moyen d'un levier. Dossier réglable séparément. Siège et dossier pivotants, rembourrés.

**Ergonomischem Stuhl für Juwelier**

Beschichtung aus Schwarzem Polyamid. Verzierung aus Synthetischem Material (Polyurethan).

**Mit 5 armigen Füßen aus Schwarzem Polyamid.**

Regulierbare Höhe von 39 bis 59 cm durch einem Gas-System mit einem Hebel. Rückenlehne separat regulierbar. Drehbarer Sitz und Rückenlehne, gepolstert.

**Ergonomic chair to jeweler**

Black polyamid outer shell. Plastic trim (polyurethane).

**On 5 branch pedestal in black synthetic material.**

Height adjustable from 40 to 56 cm by gas system with the help of a lever. Back adjustable separately. rotative seat and back.

**Silla ergonómica de joyero**

Cubierta exterior negra poliamido. Asiento y respaldo de poliuretano.

**Base con 5 ramas en materia sintética negra.**

Altura regulable de 40 a 56 cm por sistema de gas, con palanca. Respaldo ajustable separadamente. Asiento y respaldo rellenos.



No 7173

14.7 Kg

Pce Fr./10

Pce Fr.



# BERGEON

Depuis 1791

Tél. + 41 32 933 60 00  
Fax + 41 32 933 60 01

www.bergeon.ch  
info@bergeon.ch

## Polisseuse nouvelle génération Vario

Pour utilisation droitier et gaucher.

### 1 poste de travail.

Fabrication suisse.

Complètement carénée en tôle d'acier, recouverte de vernis plastifié très résistant.

Nombre de tours réglable par **variateur électronique**.

Aspiration et d'éclairage incorporé indépendant.

Protection pivotante en plexi.

Volet latéral mobile.

Bac de récupération en acier inox.

Fixation des accessoires **sur axe conique**.

### Livrée avec:

- 1 porte meule conique No 6880-HD
- 1 filtre jetable No 6699-D
- 1 tube néon No 6666-E
- 1 clef à fourche (17 mm)

### Caractéristiques techniques:

Moteur **couple constant** de 0.5 CV

Courant: 1.7 A

Conforme aux **normes** CE.

Ø de meules **maxi 200 mm.**

Accessoires: ☎ 5071 C.

## Vario Poliergeräte neue Generation

Für Benutzung rechtshändig und Linkshänder.

### 1 Arbeitsplatz.

Schweizer Fabrikat.

Komplett mit Stahlblech verkleidet, Anstrich mit hoch widerstandsfähigem plastifiziertem Schutzlack.

Anzahl der Umdrehungen kann über **elektronischen Drehzahlregler** gesteuert werden. Getrennt eingebauter Absauger und Beleuchtung.

Drehbare Schutzvorrichtung aus Plexiglas. Seitlicher beweglicher Staubabfänger. Auffangwanne aus nichtrostendem Stahl. Befestigung der Zusatzteile auf **konischer Achse**.

Drehbare Schutzvorrichtung aus Plexiglas. Seitlicher beweglicher Staubabfänger. Auffangwanne aus nichtrostendem Stahl. Befestigung der Zusatzteile auf **konischer Achse**.

Drehbare Schutzvorrichtung aus Plexiglas. Seitlicher beweglicher Staubabfänger. Auffangwanne aus nichtrostendem Stahl. Befestigung der Zusatzteile auf **konischer Achse**.

Drehbare Schutzvorrichtung aus Plexiglas. Seitlicher beweglicher Staubabfänger. Auffangwanne aus nichtrostendem Stahl. Befestigung der Zusatzteile auf **konischer Achse**.

### Lieferung mit:

- 1 konischen Verlängerungsstück Nr. 6880-HD
- 1 Wegwerffilter Nr. 6699-D
- 1 Neon-Röhre Nr. 6666-E
- 1 Gabelschlüssel

### Technische Eigenschaften:

Motor mit **konstantem Drehmoment** von 0,5 CV

Strom: 1.7 A

Gemäß **CE-Richtlinie**.

**Scheiben Ø max. 200 mm.**

Zubehörteile: ☎ 5071 C.

## New generation compact polishing unit Vario

For use right- and left-handed person

### 1 work place.

Made in Switzerland.

Completely housed in steel plate, with very resistant plasticized coating.

Machine speed in rpm is controlled by an **electronic variator**.

Independent dust collection and incorporated lighting.

Plexiglass pivot-mounted guard. Sliding side plate.

Stainless steel collection case. Accessories attached on **conical arbor**.

Stainless steel collection case. Accessories attached on **conical arbor**.

### Supplied with:

- 1 conical arbor No 6880-HD
- 1 disposable dust filter No 6699-D
- 1 neon tube No 6666-E
- 1 open-end wrench (17 mm)

### Technical characteristics:

**Constant torque** motor, 0.5 hp

Current: 1.7 A

Complies with **CE standard**.

**Max. arbor Ø: 200 mm.**

Accessories: ☎ 5071 C.

## Pulidora nueva generación Vario

Para utilización diestro y zurdo.

### 1 puesto de trabajo.

Fabricación suiza.

Completamente carenada en chapa de acero, recubierta de barniz plastificado muy resistente.

Número de vueltas regulable por **variador electrónico**.

Aspiración y luz incorporada independiente.

Protección pivotante de plexiglás. Postigo lateral móvil. Bandeja de recuperación de acero inoxidable.

Protección pivotante de plexiglás. Postigo lateral móvil. Bandeja de recuperación de acero inoxidable.

Protección pivotante de plexiglás. Postigo lateral móvil. Bandeja de recuperación de acero inoxidable.

### Se entrega con:

- 1 porta-muela cónico No 6880-HD
- 1 filtro desechable No 6699-D
- 1 tubo de neón No 6666-E
- 1 llave de horquilla (17 mm)

### Características técnicas:

Motor par **constante** de 0,5 CV

Corriente: 1.7 A

Conforme a la **norma** CE.

Ø de muelas **máximo 200 mm.**

Accesorios: ☎ 5071 C.



6890-G-220







6890-D-220

 SWISS MADE



Combinaison pour 2 postes - Kombination für 2 Posten  
Combination for 2 stations - Combinación para 2 puestos.

No	 Kg	rpm			L/P/H mm.		
6890-G-220	26	0 / 3600	410 m <sup>3</sup> /h	4W	500 x 430 x 390	220 V - 50 Hz - 0,2/0,3 kW	Pce Fr.
6890-D-220	26	0 / 3600	410 m <sup>3</sup> /h	4W	500 x 430 x 390	220 V - 50 Hz - 0,2/0,3 kW	Pce Fr.



# BERGEON

Depuis 1791

Tél. + 41 32 933 60 00  
Fax + 41 32 933 60 01

www.bergeon.ch  
info@bergeon.ch

## E-max Evolution

### Micromoteurs à grande vitesse de rotation

1'000/40'000 t/min  
Sans charbon

Excellent rapport compacité / puissance de la pièce à main.

Idéal pour travaux de précisions tels que polissage, gravure, sertissage etc.

Grands nombre d'accessoires.

Possibilité de commander alternativement 2 pièces à main.

Changement rapide de l'outil.

Qualité de finition et longévité exceptionnelle.

**Accessoires:** nous consulter pour une documentation complète.

### Mikromotor mit hoher Dreh-Geschwindigkeit

1'000/40'000 U/m  
Ohne Kohl

Vorzügliche Kompaktheit / Leistung des Handstücks.

Ideal für die Präzisions Arbeit wie Polieren, Gravieren, Einfassen, u.s.w.

Grosse Zubehör Auswahl.

Wechselweise 2 Handstücke bestellbar.

Rascher Wechsel des Werkzeugs.

Feinbearbeitung und Langleistung einmalig.

**Zubehör:** Für eine komplette Dokumentation, wenden Sie sich bitte an uns.

### Micromotor with high speed rotation

1'000/40'000 r.p.m.  
Brushless

Excellent compactness/ hand-piece power ratio.

It's an ideal machine for any precision works such as polishing, engraving, stone-setting, etc.

Wide selection of accessories.

Option to operate two hand-pieces alternatively.

Quick change of tools.

Exceptional quality of finishing and longevity.

**Accessories:** For a complete documentation, please contact us.

### Micromotor con alta velocidad de rotación

1'000/40'000 r.p.m.  
Sin carbón

Excelente relación compacidad / potencia de la pieza de mano.

Ideal para trabajos de precisión como el pulimento, grabado y engaste, etc.

Gran surtido de accesorios.

Posibilidad de pilotar alternativa-mente 2 piezas de mano.

Cambio rápido de herramienta.

Calidad excepcional.

**Accesorios:** consultarnos para recibir una documentación completa.



1'000 ~ 40'000 t/min  
4.3 cN·m

### Caractéristiques techniques

#### Boîtier de commande - Steuergerät - Controller - Mando de control

Régulation de la vitesse - Drehzahlregulierung - Speed regulation - Regulación de la velocidad

Alimentation - Netzanschluss - Main supply - Voltage

Poids - Gewicht - Weight - Peso

#### Moteur - Motor -

Pince de serrage - Spannzange - Collet - Pinza de sujeción

Poids total - Total Gewicht - Total weight - Peso totale

Puissance continue - Dauerleistung - Permanent output - Potencia continua

### Technische Daten

### Technical data

### Características técnicas

1.000 - 40.000 rpm

120 ou - oder - or 230 VAC, 50/60 Hz

2.3 kg

Ø 2.35 ou - oder - or Ø 3 mm

302 g

73 W

No 7162-115

2.6 kg

Pce Fr./10

Pce Fr.

No 7162-230

2.6 kg

Pce Fr./10

Pce Fr.





# BERGEON

Depuis 1791

Tél. + 41 32 933 60 00  
Fax + 41 32 933 60 01

www.bergeon.ch  
info@bergeon.ch

## Sableuse d'atelier

Petit modèle d'atelier avec cabine en polymère moulé; permet différentes finitions satinées sur toutes les surfaces métalliques.

Buse fixe en céramique auto-nettoyante.

Manipulation aisée des pièces à sabler.

### Avantages du système :

- Machine légère, fiable et compacte.
- Permet l'usage de différents sables (microbilles de quartz, alumine, silice, bronze, etc.)
- Idéal pour le rhabillage de boîtes de montres, bracelets, bijoux, etc.
- Machine "Cost effective".

### Caractéristiques principales :

- Manchons permettant de travailler avec des gants "nitriles".
- Buse de sablage fixe en céramique, remplaçable.
- Régulateur de pression 10 bars avec manomètre.
- Pédale de commande pneumatique.
- Substrat de sablage en circuit fermé avec filtre à particules fines.
- Système d'éclairage froid intégré.

Modèle 115 ou 220 V.

## Werkstatt Sandstrahlgeräte

Kleines Werkstatt Modell mit Geraümiger Kabine aus Polymer; erlaubt unterschiedliche seidenmatte Polierung auf allen metallischen Oberflächen.

Selbstreinigende Keramikstrahldüse.

Zuverlässig und sehr praktisch für Teile die bestrahlt sollen werden.

### Vorteile des Systems :

- leichte, zuverlässige und kompakte Maschine.
- Ermöglicht die Verwendung von verschiedenen Sanden (Mikrokügelchen aus Quarz, Aluminiumoxid, Siliziumdioxid, Bronze, usw.)
- Ideal für Uhrengehäuse, Armbänder, Schmuck, usw.
- Kostgünstige Maschine.

### Haupteigenschaften :

- Handlicher Griff, die mit Nitril-Handschuhen zu arbeiten erlauben.
- Austauschbarer Keramik-Strahldüse.
- Regelbarer Arbeitsdruck mit Manometer, 10 bar.
- Fusschaltersteuerung
- Sandsubstrat mit Kreislaufsystem und Microfilter.
- Beleuchtungssystem integriert.

Modell 220 oder 115 V.

## Sand blaster

Small workshop unit with polymer cabinet; allows different satin finishes on all metal surfaces.

Self-cleaning ceramic nozzle.

Easy handling of pieces to be gritted.

### Advantages of the system :

- Light, reliable and compact unit.
- Allows use of several sands (Microballs of quartz, alumina, silica, bronze, etc.)
- Ideal for fine repairs of watch cases, bracelet, jewels, etc.
- "Cost effective" unit.

### Main characteristics :

- Sleeves allowing to work with nitriles gloves.
- Replacable sanding ceramic nozzle.
- Pressure regulator 10 bars with manometer.
- Foot pedal control.
- Sanding substrat in closed circuit with fine particules filter.
- Integrated cold lighting system.

Modèle 115 or 220 V.

## Soplador de arena para talleres

Modelo reducido de taller con cabina en polímero moldeado, permite distintos acabados satinados sobre todos tipos de superficies metálicas.

Tubo fijo en cerámica autolimpiable.

Fácilita la manipulación de las piezas que deben arenarse.

### Ventajas del sistema :

- Máquina ligera, fiable y compacta.
- Permite el uso de distintas arenas (micro-bolas de cuarzo, alumina, sílice, bronce, etc...).
- Ideal para la compostura de cajas de relojes, pulseras, joyas, etc.
- Máquina "Cost effective".

### Características principales :

- Mangas que permiten trabajar con guantes "nitriles".
- Tubo arenador fijo en cerámica, intercambiable.
- Regulador de presión 10 bares con manómetro.
- Pedal de mando neumático.
- Substrato de arenado en circuito cerrado con filtro a partículas finas.
- Sistema de alumbrado frío integrado.

Modelo 115 ó 220 V.

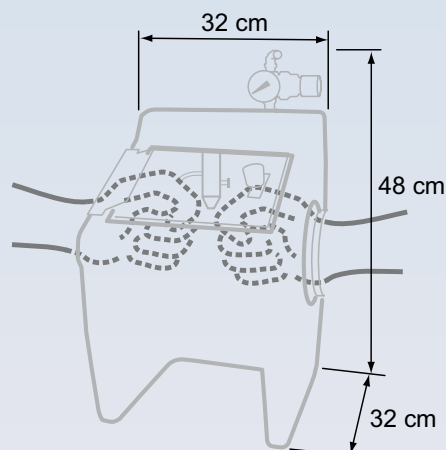

No 7069

4.250 Kg

Pce Fr.





# BERGEON

Depuis 1791

Tél. + 41 32 933 60 00  
Fax + 41 32 933 60 01

www.bergeon.ch  
info@bergeon.ch

## Nouveau micromoteur professionnel

**idéal pour vos travaux d'usinage.**

Le micromoteur TopSpin est un appareil de haute qualité technique pour l'ébavurage, le meulage, le polissage et autres travaux similaires. Il est utilisé dans l'industrie, dans la fabrication d'outils et la construction de moules, la fabrication de maquettes, ainsi qu'en bijouterie. L'appareil réunit de manière optimale fonction et design.

La commande se fait, comme sur un écran tactile, par l'intermédiaire de commutateurs capacitifs intégrés. Ceux-ci sont absolument inusables. En option, il est possible de régler la vitesse sans paliers grâce à un régulateur à pédale.

TopSpin se caractérise par une construction d'une solidité exceptionnelle de tous les composants, qui sont réalisés en matériaux de grande qualité.

Il est possible de commander deux différents types de pièces à main avec le même boîtier de commande.

Vous évitez ainsi le changement d'outil permanent. .

Pince de serrage et jeu d'outils pour le diamètre de 2.35 mm ou 3 mm.

## Neue professioneller Handsleifspindel

**Volltreffer für Ihre Metallbearbeitung.**

Die Handsleifspindel TopSpin ist ein technisch hochwertiges Gerät für das Entgraten, Schleifen, Polieren und ähnliche Arbeiten. Eingesetzt wird sie in der Industrie, im Werkzeug- und Formenbau, im Modellbau sowie in der Schmuckherstellung. Das Gerät vereint Funktion und Design in optimaler Weise.

Die Bedienung erfolgt - ähnlich wie bei einem Touchpanel - direkt auf der Frontplatte aus Glas über integrierte kapazitive Schalter. Diese sind absolut verschleissfrei.

Als Option kann die Drehzahl stufenlos über einen Fussregler eingestellt werden.

Der TopSpin zeichnet sich aus durch überdurchschnittlich stabile Konstruktion aller Komponenten sind aus hochwertigen Materialien.

Bei Bedarf kann das Gerät mit einem zweiten Handstück nachgerüstet werden.

Sie vermeiden damit ständigen Werkzeugwechsel.

Spannzange und Werkzeugset für Durchmesser 2.35 mm oder 3 mm.

## New professional microgrinder

**A direct hit for your metal processing works.**

The microgrinder TopSpin is a technically highquality apparatus for burring, grinding, polishing and similar jobs. It is employed in industry, in tool and mould manufacture, in pattern and jewellery making. The apparatus optimally combines function and design.

The apparatus is operated - similar to a touch panel - directly on the glass front panel by means of integrated proximity switches. These are absolutely resistant to wear.

As an option, the speed can be continuously adjusted by means of a variable-speed foot rheostat.

TopSpin features an above-average stable construction of all components of high-quality materials.

The apparatus can be retrofitted with a second handpiece if desired.

You will thus avoid constant tool change.

Collet and tool set for diameter 2.35 or 3 mm.

## Nuevo micromotor profesional

**Ideal para elaboración.**

El micromotor Topspin es de alta calidad técnica para desrebabar, amolar y pulir.

Es utilizado en la industria dentro de la fabricación de herramientas, construcción de moldes y bisutería. Reúne de manera optimal función y diseño.

Los ajustes se hacen al igual que una pantalla táctil a través de comandos capacitivos integrados. Estos últimos son absolutamente inusables.

En opción se puede variar la velocidad en continuo gracias a un regulador a pedal.

Topspin se caracteriza con una elaboración y una robustez excepcional de todos sus componentes que son realizados en materiales de gran calidad.

Posibilidad de pedir dos diferentes tipos de piezas a mano con el mismo mando de control.

De este modo se evita el cambio de herramientas permanentemente.

Pinza de sujeción y juego de herramientas para diámetros de 2.35 mm o 3 mm.

0.017 Nm  Ø 2.35 - 3.00 mm

No 7160-A-230

6.400 Kg

Pce Fr.

  
**BERGEON**  
by **LEHMANN**®  
präzision 





# BERGEON

Depuis 1791

www.bergeon.ch  
info@bergeon.ch

Tél. + 41 32 933 60 00  
Fax + 41 32 933 60 01

## Kit

- 1 Boîtier de commande - Steuergerät - Controller - Mando de control
- 1 Pièce à main - Handstück - Handpiece - Pieza de mano
- 1 Câble de connexion - Verbindungskabel - Cableconnexion - Cable de conexión
- 2 Pincettes de serrage - Spannzangen - Collet - Pinzas de sujeción  
Ø 2.35 et - und - and - y Ø 3 mm
- 1 Support pour pièce à main - Handstückablagen - Handpiece cradles -  
Soporte para pieza de mano
- 5 Fraises et 5 meules - 5 HM-Fräser und 5 Schleifstifte - 5 twheels and 5 cutters -  
5 fresas y 5 muelas ESP
- 1 Câble de raccordement - Anschlußkabel - Connecting cable - Cable de conexión
- 2 Outils pour changement des pincettes - Werkzeug für Spannzangenwechsel für  
Spannzangenwechsel - Tools for collet change - Herramienta para cambiar pinzas
- 1 Clé à ergot - Hakenschlüssel - Sickle spanner - Llave a espigón
- 1 Instructions de service - Handbuch - Instructions boock - Instrucciones de servicio

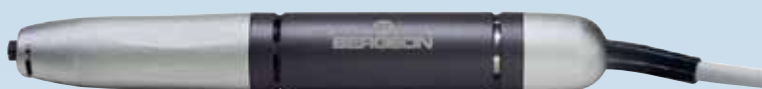

7160-01



En option  
In Option  
En opción



Desserrage et serrage de la pince  
Öffnen und schliessen der Zange  
Loosing and tightening of the pliers  
Aflojamiento y sujeción de la pinza

Dévisage de la pince  
Entschrauben der Zange  
Unscrewing of the pliers  
Destornillamiento de la pinza

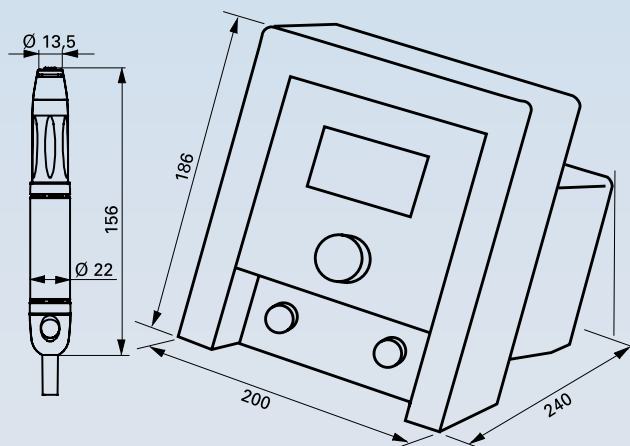

## Caractéristiques techniques

## Technische Daten

## Technical data

## Características técnicas

### Boîtier de commande - Steuergerät - Controller - Mando de control

Régulation de la vitesse - Drehzahlregulierung - Speed regulation - Regulación de la velocidad  
Alimentation - Netzanschluss - Main supply - Voltage  
Poids - Gewicht - Weight - Peso

3.000 < 50.000 rpm  
230 VAC  
6.1 kg

### Pièce à main - Handstück - Handpiece - Pieza de mano

Pince de serrage - Spannzange - Collet - Pinza de sujeción  
Poids - Gewicht - Weight - Peso  
Tension de service - Betriebsspannung - Operating voltage - Voltage  
Puissance continue - Dauerleistung - Permanent output - Potencia continua

Ø 2.35 ou - oder - or Ø 3 mm  
300 g  
36 VDC max.  
60 W



**BERGEON**

*Integrator*



est la réponse à vos questions et vous décharge de tous les soucis.  
*is the answer to your requiries and release you of all toubles.*



est à votre disposition et prend en compte vos besoins.  
*is at your disposition and takes your needs into consideration.*



vous offre une solution clés en mains.  
*offers you a turn-Key solution.*

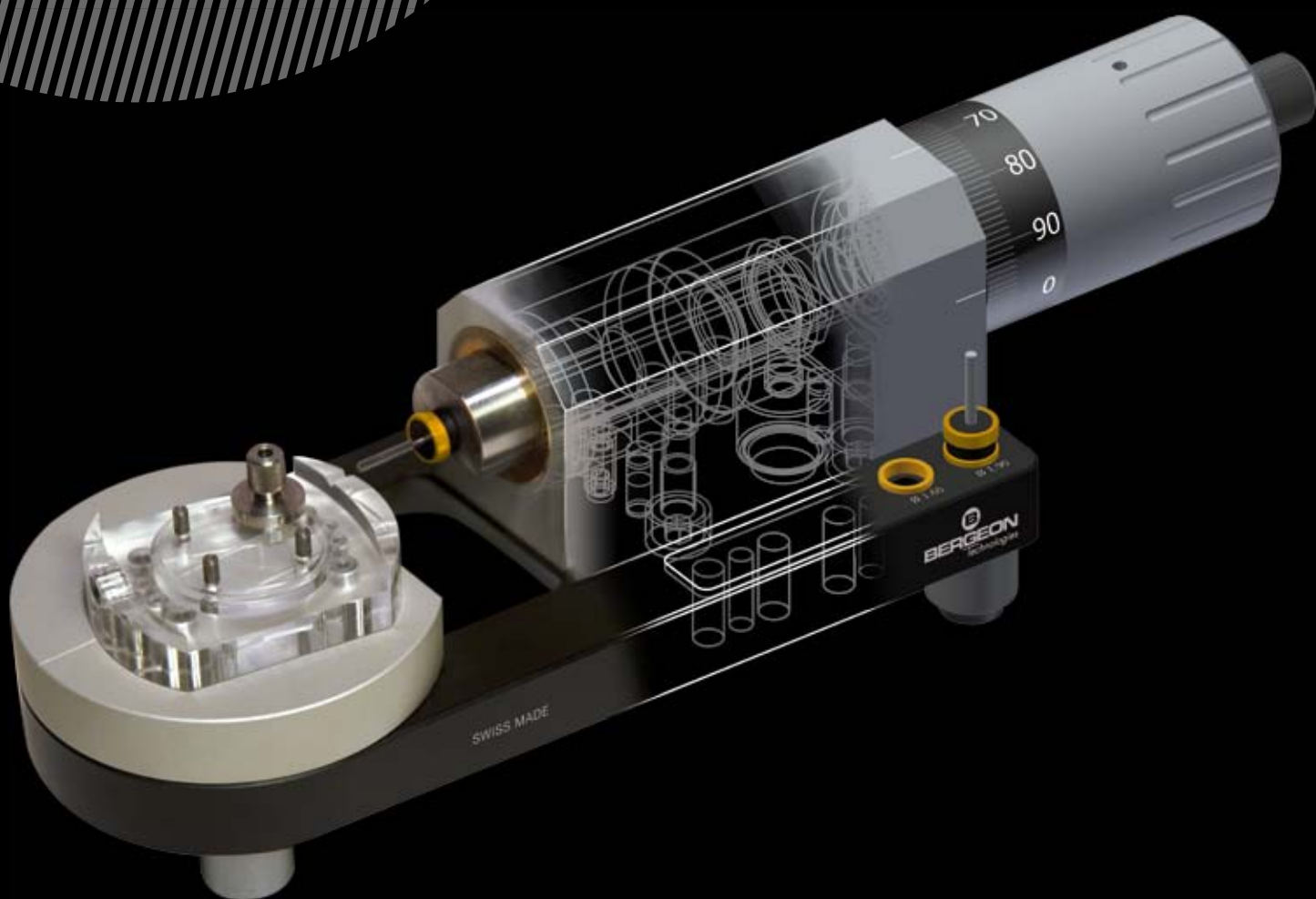

**B**  
**BERGEON**  
Depuis 1791

LE REFLET DE VOTRE EXIGENCE

220<sup>th</sup>  
ANNIVERSARY  
1791 | 2011