

**B**  
**BERGEON**  
D e p u i s 1 7 9 1

# NEWS



**Bergeon SA**  
11, av. du Technicum  
CH-2400 Le Locle

**Outillages et équipements pour l'horlogerie,  
la bijouterie et la microtechnique**

Tél. +41 32 933 60 00 - Fax +41 32 933 60 01  
info@bergeon.ch - www.bergeon.ch

[www.bergeon.ch](http://www.bergeon.ch)

**Site Internet** comprenant :

- Shop en ligne, téléchargements
- vidéos, fiches techniques
- Informations générales,

**Web Seite** umfasst :

- Shop on ligne,
- Unterladen von vidéos,
- technische Daten
- Allgemeine Informationen

**Web site** containing :

- On Line shop,
- Downloading videos,
- technical datas
- General informations

**Portal Internet** que incluye :

- Shop en línea,
- descargas,
- videos,
- fichas técnicas
- Información general



- Le catalogue **Général**,
- Catalogue **Essentiel**
- **site internet.**

- The **general** Catalog
- **Essentiel** Catalog
- **Web site**

- *Der Haupt Katalog*
- *Essentiel Katalog*
- *Webseite*

- *El catálogo General,*
- *Catálogo Essentiel*
- *Portal Internet.*



**Usinage/fabrication**

- CNC
- **Gravage Laser**
- **Assemblage**

**Herstellung/Produktion**

- CNC
- **Lasergravierung**
- **Montage**

**Machining/Production**

- CNC
- **Laser engraving**
- **Assembling**

**Producción/fabricación**

- CNC
- **Marcage Láser**
- **Montaje**

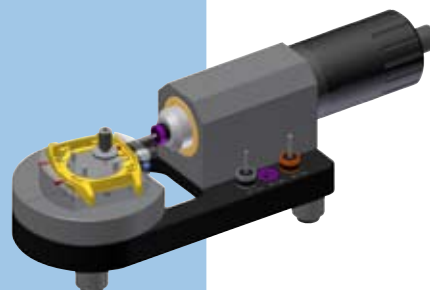

SolidWorks

- R+D, en collaboration avec vos Bureaux méthodes, SAV, et industrialisation
- Prise en charge de vos contraintes
- Evolution possibles en cours de projet

- *R+D, in Zusammenarbeit mit Ihren Kundendiensten, und technische Abteilung*
- *Industrialisierung*
- *Integrierung Ihre Vorzüge*
- *Evolution jederzeit möglich*

- R&D, in cooperation with your After sales service, method office and industrialization
- Taking care of your restraints
- Possible evolution while a project in process

- *I+D, en colaboración con sus oficinas métodos, SAV, e industrialización*
- *Encarga de sus dificultades*
- *Evoluciones posibles en curso de proyecto*

- Maîtrise des contraintes techniques
- Maîtrise des énergies
- Un ou plusieurs postes de travail
- Solution clés en mains

- Control technical constraints
- Energies Control
- One or more work stations
- Turn-key solutions

- *Beherrschung der technischen Zwänge*
- *Energie Beherrschung*
- *Ein oder mehrere Arbeitsplätze*
- *Komplette Lösungen*

- *Dominio de las dificultades técnicas*
- *Control de energías*
- *Uno o varios puestos de trabajo*
- *Solución clave en manos*



Machines et équipements  
*Maschinen und Ausstattungen*  
Machines and equipments  
*Máquinas y equipamientos*

Maîtrise des énergies  
*Energie Beherrschung*  
Energies Control  
*Dominio de las energías*

- **Optimisation des espaces**
- **Solutions incluant équipements et impératifs logistiques**

- *Optimierung der Räume*
- *Lösungen, die logistische Ausstattungen und Ihre Wünschen umfassen*

- **Spaces optimization**
- **Solutions including equipments and logistic requirements**

- **Optimización de espacios**
- **Soluciones que incluyen equipamientos e imperativos logísticos**

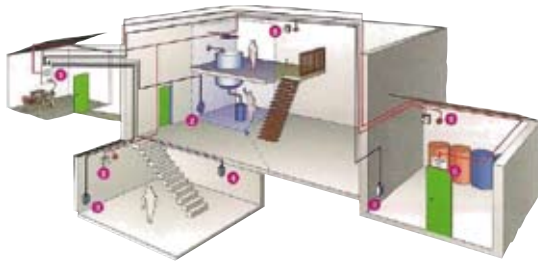

- **Lay-out** intégré dans la démarche marketing.
- **Recherche** de solutions avec votre marketing
- **Projet 3D**
- **Modélisation 3D**

- *Lay-out integriert im Marketing Prozess*
- *Lösungssuche mit Ihrem Marketing*
- *Projekte 3D*
- *Modellbau 3D*

- Integrated **Lay-out** in the Marketing procedure
- **Solutions** research with your Marketing
- **3D Project**
- **3D Modeling**

- *Lay-out integrada en la gestión Marketing.*
- *Búsqueda de soluciones con su comercialización*
- *Proyecto 3D*
- *Modelización 3D*



- **Solutions intégrées**
- **Visuels stratégique**
- **Personnalisation** de la gamme «Essentiel»
- **Gravage Laser**

- **Integrated Solutions**
- **Visual Strategy**
- **Personnalisation** of «Essentiel» range
- **Laser engraving**

- *Integrierte Lösungen*
- *Strategischen Sichten*
- *Personifizierung* von «Essentiel» Produkten
- *Lasergravierung*

- *Soluciones integradas*
- *Visuales estratégico*
- *Personalización* de la gama «Essentiel»
- *Marcage Láser*





# BERGEON

Depuis 1791

Tél. + 41 32 933 60 00  
Fax + 41 32 933 60 01

www.bergeon.ch  
info@bergeon.ch

## Tournevis HH ergonomiques à adaptateurs rapides (Haute Horlogerie)

Cette nouvelle gamme de tournevis en aluminium est l'alliance de qualité, technique et confort.

Par simple pression sur la tête du tournevis, l'adaptateur et sa mèche sont rapidement extraits pour en repositionner une nouvelle.

**Corps:** Aluminium anodisé.

**Mécanisme:** Acier.

**Tête:** Aluminium anodisé, montée sur roulement à billes.

**Mèches:** Acier inox durci.

Ø des mèches: 0.50, 0.60, 0.80, 1.00, 1.20, 1.40, 1.60, 2.00, 2.50 et 3.00 mm.

## Ergonomische Schraubenzieher HH mit schnell Adapter (Haute Horlogerie)

Diese neue Reihe von Aluminium-schraubenzieher verbindet hohe Technik mit Leichtigkeit und Komfort.

Mit einem Druck auf den Kopf des Schraubenziehers wird der Adapter mit Klinge schnell ausgewechselt.

**Körper:** Anodischer Aluminium.

**Mechanismus:** Stahl.

**Kopf:** Anodischer Aluminium auf Kugellager.

**Klinge:** gehärteter rostfreier Stahl.

Ø der Klingen: 0.50, 0.60, 0.80, 1.00, 1.20, 1.40, 1.60, 2.00, 2.50 und 3.00 mm.

## Ergonomic screwdrivers HH with fast adapters (Haute Horlogerie)

This new range of aluminium screwdrivers combines easy-to-use, high-tech and comfort.

With a single pressure on the top of the screwdriver, the adapter with the blade are quickly removed in order to change and set a new blade.

**Body:** Anodized Aluminium.

**Mechanism:** Steel.

**Head:** Anodized Aluminium on ball bearing.

**Blade:** Hardened stainless steel.

Ø of the blades: 0.50, 0.60, 0.80, 1.00, 1.20, 1.40, 1.60, 2.00, 2.50 and 3.00 mm.

## Destornillador ergonómico con adaptadores rápido (Haute Horlogerie)

Esta nueva gama de destornillador en aluminio es la alianza entre la practicidad, técnica y confort.

Presionando simplemente la cabeza del destornillador, el adaptador con la mecha es rápidamente extraído para reponer una nueva mecha.

**Cuerpo:** Aluminio anodizado.

**Mecanismo:** Acero.

**Cabeza:** Aluminio anodizado, montado sobre cojinete de bolas.

**Mechas:** De acero endurecido.  
Ø de las mechas: 0.50, 0.60, 0.80, 1.00, 1.20, 1.40, 1.60, 2.00, 2.50 y 3.00 mm.

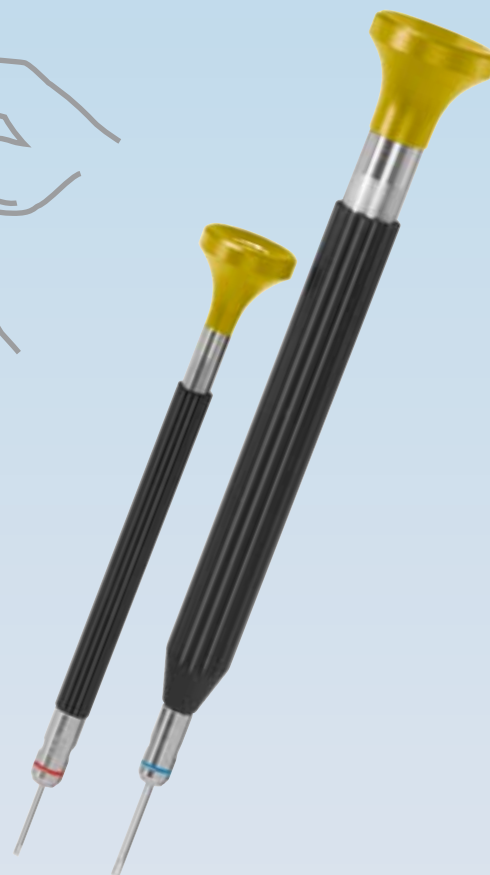
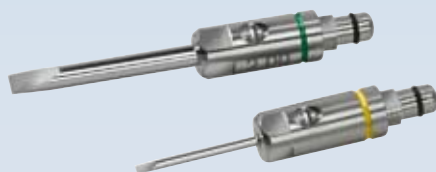
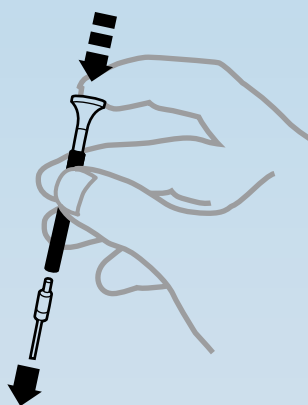



3 types d'assortiments

3 verschiedene Sortimenten

3 kinds of assortments

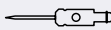
3 types d'assortiments

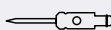
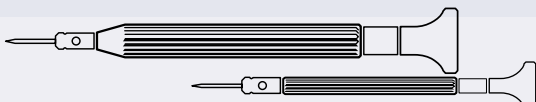
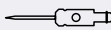
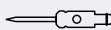
No	gr.	Pce Fr.		
7063-A6-P	546			 6x Ø 0.50 > 1.40 mm
7063-A6-G	570			 6x Ø 0.1.20 > 3.00 mm
7063-A10-GP	774			 5x Ø 0.50 > 1.20 mm  5x Ø 1.40 > 3.00 mm





# BERGEON

Depuis 1791

Tél. + 41 32 933 60 00  
Fax + 41 32 933 60 01

www.bergeon.ch  
info@bergeon.ch

## Tournevis ergonomiques en aluminium

La nouvelle gamme de tournevis propose des outils alliant qualité technique et confort d'utilisation. Les tournevis sont garnis d'une membrane en élastomère assurant un contact idéal entre l'outil et la main, alors que la tête octogonale améliore le confort.

**Corps:** Aluminium anodisé.  
**Manche:** Garnitures élastomère TPE.

**Tête:** En matière synthétique POM (Delrin) autolubrifiant.

**Mèches:** Acier inox durci.

## Ergonomischen Schraubenziehern in Aluminium

Die neue Serie von Schraubenziehern bietet Werkzeuge an, welche technische Qualität und komfortable Anwendung miteinander verbinden. Die Schraubenzieher sind mit einem Überzug aus Elastomer ausgestattet, welcher einen idealen Kontakt zwischen Werkzeug und der Hand gewährleistet, sowie einem oktogonalen Kopf, welcher die Handhabung verbessert.

**Schaft:** Eloxiertes Aluminium.

**Überzug:** Elastomer TPE.

**Kopf:** aus synthetischem Material POM (Delrin), selbstschmierend.

**Klingen:** Edelstahl gehärtet.

## Ergonomic screwdrivers in aluminium

The new screwdriver range's tools combine technical quality and confort of use. The screwdrivers are provided with an elastomer membran which assures an ideal contact between the tool and the hand, while the octagonal head enhances the confort.

**Shank:** Anodized aluminium.

**Handle:** TPE elastomer coat.

**Head:** Self-lubricating, synthetic POM (Delrin) material.

**Blades:** Hardened stainless steel.

## Destornilladores ergonómicos en aluminio

La nueva gama de destornilladores combine la calidad técnica y el confort de uso. Los destornilladores son cubiertos de una membrana de elastómero que asegura un contacto ideal entre la herramienta y la mano, mientras tanto la cabeza octágonal mejora el confort.

**Cuerpo:** Aluminio anodizado.

**Mancha:** Guarnición elastómero TPE.

**Cabeza:** de materia sintética POM (Delrin) autolubrificante.

**Mechas:** De acero inoxidable endurecido.



No 7899

90 gr.

Pce Fr.

 SWISS MADE



### Jeu de 9 tournevis sur socle tournant.

Avec emplacement pour les mèches de rechange.

**Drehbare Sockel mit 9 Schraubenziehern.**

Markierten Reservoiren für Ersatzklingen.

**Rotating stand with 9 screwdrivers.**

Coloured slots for spare blades.

**Surtido de 9 destornilladores sobre zócalo giratorio.**

Con emplazamiento para las mechas de recambio.

Ø 0.50 - 0.60 - 0.80 - 1.00 - 1.20 - 1.40 - 1.60 - 2.00 - 2.50 mm.



### Jeu de 10 tournevis sur socle tournant.

Avec emplacements pour les tubes et mèches de rechange.

**Drehbare Sockel mit 10 Schraubenziehern.**

Markierten Reservoiren für Ersatzklingen.

**Rotating stand with 10 screwdrivers.**

Coloured slots for spare blades.

**Surtido de 10 destornilladores sobre zócalo giratorio.**

Con emplazamiento para las mechas de recambio.

Ø 0.50 - 0.60 - 0.80 - 1.00 - 1.20 - 1.40 - 1.60 - 2.00 - 2.50 - 3.00 mm.

No 7899-S09

320 gr.

Pce Fr.

No 7899-S10

930 gr.

Pce Fr.



# BERGEON

Depuis 1791

www.bergeon.ch  
info@bergeon.ch

Tél. + 41 32 933 60 00  
Fax + 41 32 933 60 01

## Tournevis ergonomiques en aluminium

**Corps: Aluminium anodisé.**  
Manche: Garnitures élastomère TPE.  
Tête: En matière synthétique POM, de différentes couleurs.  
Mèche: Acier inox durci 54 HRC.

## Ergonomischen Schraubenziehern in Aluminium

**Schaft: Eloxiertes Aluminium.**  
Heft: Überzug Elastomer TPE.  
Kopf: In Kunststoff POM, unterschiedliche Farben.  
Klinge: Edelstahl gehärtet 54 HRC.

## Ergonomic screwdrivers in aluminium

**Shank: Anodized aluminium..**  
Handle: Elastomer coat TPE.  
Head: In synthetic POM, of various colors.  
Blade: Hardened stainless steel 54 HRC.

## Destornilladores ergonómicos en aluminio

**Cuerpo: Aluminio anodizado.**  
Mancha: Guarnición elastómero TPE.  
Cabeza: En materia sintética POM, de diferentes colores.  
Mecha: Acero inoxidable endurecido 54 HRC.

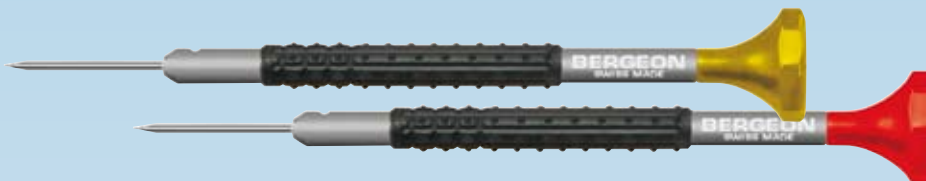

Sans mèches de rechange  
Ohne Ersatzklingen  
Without spare blades  
Sin mechas de recambio

Avec mèches de rechange en tubes plastique gris  
Mit Ersatzklingen in grauen Plastiktuben  
With spare blades in grey plastic tubes  
Con mechas de recambio en tubitos de plástico gris

Mèche Klinge Blade Mecha Ø mm	Couleur Farbe Colour Color	No	Pce Fr. / 100	Pce Fr. / 10	Pce Fr.	No	Pce Fr. / 100	Pce Fr. / 10	Pce Fr.
0.50		7899-050				7899-AT-050			
0.60		7899-060				7899-AT-060			
0.80		7899-080				7899-AT-080			
1.00		7899-100				7899-AT-100			
1.20		7899-120				7899-AT-120			
1.40		7899-140				7899-AT-140			
1.60		7899-160				7899-AT-160			
2.00		7899-200				7899-AT-200			
2.50		7899-250				7899-AT-250			
3.00		7899-300				7899-AT-300			



# BERGEON

Depuis 1791

Tél. + 41 32 933 60 00  
Fax + 41 32 933 60 01

www.bergeon.ch  
info@bergeon.ch

## Tournevis ergonomiques entièrement en acier inoxydable

Corps et manche en acier inox durci.

Tête en matière synthétique POM (Delrin) autolubrifiant.

Mèches en acier inox durci.

## Ergonomischer Schraubenziehern gänzlich aus Inox

Schaft und Überzug aus Edelstahl.

Kopf aus synthetischem Material POM (Delrin), selbstschmierend.

Klingen aus Edelstahl gehärtet.

## Entirely stainless steel ergonomic screwdrivers

Shank and handle in stainless steel.

Head in self-lubricating, synthetic POM (Delrin) material.

Blades in hardened stainless steel.

## Destornilladores ergonómicos en acero inoxidable

Cuerpo y mango en acero inoxidable endurecido

Cabeza en materia sintética POM delrin autolubrificante

Mechas en acero inoxidable endurecido



No 30081

90 gr.

Pce Fr.



 SWISS MADE



### Jeu de 9 tournevis sur socle tournant.

Avec emplacement pour les mèches de rechange.

**Drehbare Sockel mit 9 Schraubenziehern.**

Markierten Reservoiren für Ersatzklingen.

**Rotating stand with 9 screwdrivers.**

Coloured slots for spare blades.

**Surtido de 9 destornilladores sobre zócalo giratorio.**

Con emplazamiento para las mechas de recambio.

Ø 0.50 - 0.60 - 0.80 - 1.00 - 1.20 - 1.40 - 1.60 - 2.00 - 2.50 mm.

### Jeu de 10 tournevis sur socle tournant.

Avec emplacements pour les tubes et mèches de rechange.

**Drehbare Sockel mit 10 Schraubenziehern.**

Markierten Reservoiren für Ersatzklingen.

**Rotating stand with 10 screwdrivers.**

Coloured slots for spare blades.

**Surtido de 10 destornilladores sobre zócalo giratorio.**

Con emplazamiento para las mechas de recambio.

Ø 0.50 - 0.60 - 0.80 - 1.00 - 1.20 - 1.40 - 1.60 - 2.00 - 2.50 - 3.00 mm.

No 30081-S

320 gr.

Pce Fr.

No 3054-A

930 gr.

Pce Fr.

**Tournevis ergonomiques  
entièrement  
en acier inoxydable**

**Ergonomischer  
Schraubenziehern  
gänzlich aus Inox**

**Entirely stainless steel  
ergonomic screwdrivers**

**Destornilladores  
ergonómicos  
en acero inoxidable**



**Jeu de 5 tournevis en étui bois.**  
Avec mèches de rechange.

**Holzetui mit 5 Schraubenziehern.**  
Mit Ersatzklingen.

**Wooden case with 5 screwdrivers.**  
With spare blades.

**Surtido de 5 destornilladores en estuche de madera.**  
con mechas de recambio.

Ø 0.50 - 0.60 - 0.80 - 1.00 - 1.20 mm

No 30081-A05

155 gr.

Pce Fr.



**Jeu de 10 tournevis en étui bois.**  
Avec mèches de rechange.

**Holzetui mit 10 Schraubenziehern.**  
Mit Ersatzklingen.

**Wooden case with 10 screwdrivers.**  
With spare blades.

**Surtido de 10 destornilladores en estuche de madera.**  
con mechas de recambio

Ø 0.50 - 0.60 - 0.80 - 1.00 - 1.20 - 1.40 - 1.60 - 2.00 - 2.50 - 3.00 mm.

No 30081-A10

280 gr.

Pce Fr.





Tél. + 41 32 933 60 00  
Fax + 41 32 933 60 01

# BERGEON

Depuis 1791

www.bergeon.ch  
info@bergeon.ch

## Nouvel appareil à contrôler l'étanchéité des boîtes de montres

A pression d'air.

Cylindre amovible pour vidanger. Raccord pour compresseur ou pompe. Mise en pression manuelle de 0 à 11 atm.

Crochet pour montre en matière synthétique.

**Capacité de contrôle: 0-11 atm. (sécurité à 12 atm.).**

Bâti en fonte d'aluminium.

Robuste, très stable.

Cylindre Ø int.: 70 mm.

Capacité de contenance: 2 montres.

Dimensions: 275 x 167.5 x 390 mm.

## Neu Apparat zur Kontrolle der Wasserdichtigkeit von Uhrgehäusen

Mit Luftdruck.

Zylinder abnehmbar zur Entleerung. Anschluss für Kompressor oder Pumpe. Druckregulierung von 0-11 Atü.

Haken für Uhr aus synthetischem Material.

**Kontrollkapazität 0-11 Atü (Sicherheit bei 12 Atü).**

Gestell aus Aluminiumguss.

Robust und sehr stabil.

Zylinder Innen Ø: 70 mm.

Kapazität: 2 Uhren.

Dimensionen: 275 x 167.5 x 390 mm.

## New apparatus for testing the water resistance of watch cases

Air pressure system.

Removable cylinder for draining. Connector for compressor or pump.

Manual pressure from 0 to 10 atm.

Hook for synthetic matter watch.

**Control Capacity : 0-11 atm. (security at 12 atm).**

Built in aluminium cast iron.

Strong, very stable.

Cylinder Ø: 70mm.

Volume capacity: 2 watches.

Dimensions: 275 x 167.5 x 390 mm.

## Nuevo aparato para controlar la impermeabilidad de las cajas de relojes

Con presión de aire.

Cilindro amovible para desaguar. Conectado para compresor o bomba. Puesta en presión manual de 0 a 10 atm.

Gancho para reloj en materia sintética.

**Capacidad de control: 0-11atm. Seguridad a 12 atm.**

Bastidor de fundición de aluminio.

Robusto, muy estable.

Cilindro Ø int.: 70mm.

Capacidad: 2 relojes.

Dimensiones: 275 x 167.5 x 390 mm.

## BERGEON No 5555/10

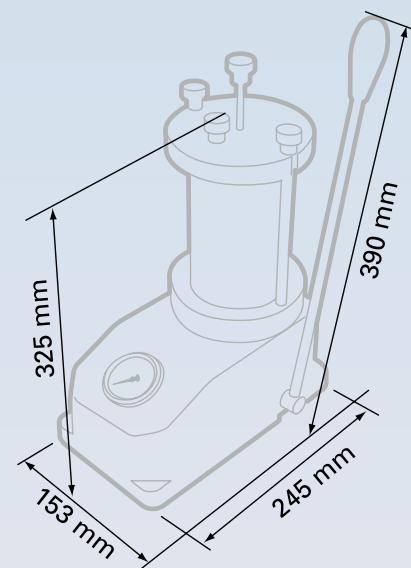



**Cylindre amovible pour vidanger**  
**Zylinderv abnehmbar zur Entleerung**  
**Removable cylinder for draining**  
**Cilindro amovible para desaguar**



No 5555/10-TP

545 gr.

Pce Fr.

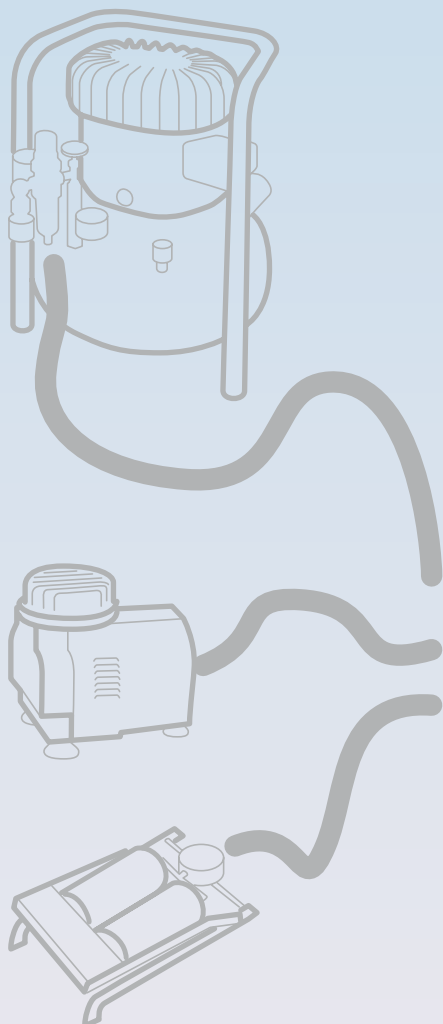

G 1/4

**Raccord pour compresseur ou pompe**  
**Anschluss für Kompressor oder Pump**  
**Connector for compressor or pump**  
**Conectado para compresor o bomba**

No 5555/10-R

545 gr.

Pce Fr.



# BERGEON

Depuis 1791

Tél. + 41 32 933 60 00  
Fax + 41 32 933 60 01

www.bergeon.ch  
info@bergeon.ch

## Potence à ouvrir et fermer les boîtes étanches

Nouveaux socle et étau spécialement conçu pour pièces de grandes dimensions.

Ouverture jusqu'à 60 mm.

Socle bois: 250 x 95 mm.

Hauteur totale: 300 mm.

Ø du volant: 130 mm.

Bâti en fonte injectée.

## Presstock zum Öffnen und Schliessen wasserdichter Uhrgehäuse

Neuen Sockel und Schraubstock speziell hergestellt für Gehäuse mit Grossen Durchmesser.

Öffnung bis 60 mm.

Holzsockel: 250 x 95 mm.

Gesamthöhe: 300 mm.

Schwungrad Ø : 130 mm.

Gestell aus Spritzguss.

## Device for opening and closing waterproof watch cases

New base and vice especially created for big cases. Opening up to 60 mm.

Wooden stand: 250 x 95 mm.

Total height: 300 mm.

Ø of the hand wheel: 130 mm.

Die-cast frame.

## Potenza para abrir y cerrar las cajas impermeables

Nuevo zócalo y torno especialmente concebido para partes de grandes dimensiones.

Apertura hasta 60 mm.

Zócalo de madera: 250 x 95 mm.

Altura total: 300 mm.

Ø del volante: 130 mm.

Armadura de fundición inyectada.



### Comprenant - Mit - Including - Con:

	2x	No 2835-A
	2x	No 2835-B
	2x	No 2835-C
	2x	No 2835-D
	2x	No 2835-E
	2x	No 2835-F
	4x	9-11 mm 13-15 mm 17-19 mm 20-22 mm
	1x	No 5700-04-G

### Socle bois - Holzsockel - Wooden stand - Zócalo de madera.

No 5700-Z	2.950 kg	Pce Fr.
-----------	----------	---------

### Socle matière synthétique - Sockel synthetisches Material. Synthetic stand matter - Zócalo materia sintética.

No 5700-Z-D	2.950 kg	Pce Fr.
-------------	----------	---------



**Étau seul.** Ouverture jusqu'à 60 mm.

**Nur Schraubstock.** Öffnung bis 60 mm.

**Vice alone.** Opening up to 60 mm.

**Solo tornillo.** Apertura hasta 60 mm.

No 5700-04-G	214 gr.	Pce Fr.
--------------	---------	---------



www.bergeon.ch  
info@bergeon.ch

# BERGEON

Depuis 1791

Tél. + 41 32 933 60 00  
Fax + 41 32 933 60 01

## Potence à ouvrir et fermer les boîtes étanches

Ouverture jusqu'à 60 mm.  
Socle bois: 250 x 95 mm.  
Hauteur totale: 300 mm.  
Ø du volant: 130 mm.  
Bâti en fonte injectée.

## Presstock zum Öffnen und Schliessen wasser- dichter Uhrgehäuse

Öffnung bis 60 mm.  
Holzsockel: 250 x 95 mm.  
Gesamthöhe: 300 mm.  
Schwungrad Ø: 130 mm.  
Gestell aus Spritzguss.

## Device for opening and closing waterproof watch cases

Opening up to 60 mm.  
Wooden stand: 250 x 95 mm.  
Total height: 300 mm.  
Ø of the hand wheel: 130 mm.  
Die-cast frame.

## Potenza para abrir y cerrar las cajas impermeables

Apertura hasta 60 mm.  
Zócalo de madera: 250 x 95 mm.  
Altura total: 300 mm.  
Ø del volante: 130 mm.  
Armadura de fundición inyectada.



### Comprenant - Mit - Including - Con:

	2x	No 2835-A
	2x	No 2835-B
	2x	No 2835-C
	2x	No 2835-D
	2x	No 2835-E
	2x	No 2835-F
	4x	9-11 mm 13-15 mm 17-19 mm 20-22 mm No 5700-B-C-D-E
	6x	Ø 16 - 19 - 22 mm 26 - 30 - 34 mm No 5700-F-G-H-J-K-L
	3x	Ø 19 - 26 - 34 mm No 5700-M-N-P
	1x	No 5700-04-G

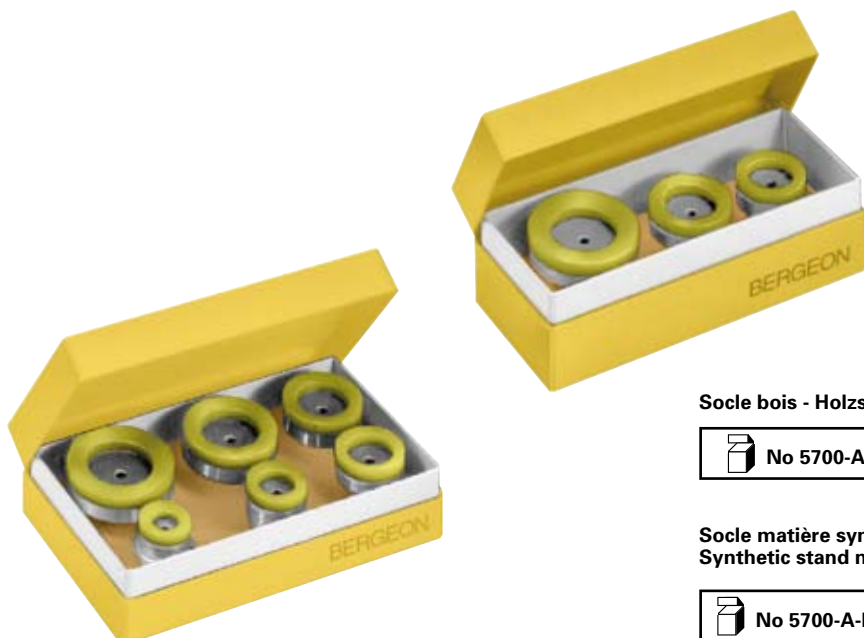

### Socle bois - Holzsockel - Wooden stand - Zócalo de madera.

	No 5700-A	3.450 kg	Pce Fr.
--	-----------	----------	---------

### Socle matière synthétique - Sockel synthetisches Material. Synthetic stand matter - Zócalo materia sintética.

	No 5700-A-D	3.450 kg	Pce Fr.
--	-------------	----------	---------





# BERGEON

Depuis 1791

Tél. + 41 32 933 60 00  
Fax + 41 32 933 60 01

www.bergeon.ch  
info@bergeon.ch

## Dispositif pour perforer les bracelets

Réalisé pour un travail efficace et pratique.

Structure en aluminium.

Forme ergonomique et très maniable.

Permet d'effectuer des trous de toutes formes dans des bracelets en cuir, tissu ou caoutchouc.

Épaisseur: 4.5 mm max.

Largeur: 26 mm max.

Se compose de poinçons, matrices et pions de centrage.

Réglage simple de l'intervalle des trous.

Ø des trous ronds:

1.00, 1.50, 2.00, 2.50 et 3.00 mm

D'autres formes sur demande.

## Armbänderlochapparat

Speziell entwickelt um praktisch und effizient zu Arbeiten.

Struktur aus Aluminium.

In ergonomischer und handlicher Form.

Um Löcher mit verschiedenen Formen in Leder-, Stoff- oder Kautschukarmbänder zu machen.

Dicke: max. 4.5 mm.

Breite: max. 26 mm.

Geliefert mit Punzen, Matrize und Sperrstiften.

Einfache Einstellung vom Abstand den Löchern

Ø von runden Löchern:

1.00, 1.50, 2.00, 2.50 und 3.00 mm.

Andere Formen: auf Anfrage.

## Watch-strap punching device

Designed for a very efficient and practical work.

Aluminium frame.

Ergonomic and easy to use.

Enable to make holes of various shapes in leather, cloth or rubber straps.

Thickness: 4.5 mm max.

Width: 26 mm max.

Contains punches, dies and centring pins.

Easy setting of punching intervals.

Ø of round holes:

1.00, 1.50, 2.00, 2.50 and 3.00 mm.

Other shapes: on demand.

## Dispositivo para perforar las pulseras

Realizado para trabajar de modo eficaz y práctico.

Estructura en aluminio.

Forma ergonómica y de fácil manejo.

Permite efectuar agujeros de todas las formas en pulseras de cuero, tejido o caucho.

Espesor: 4.5 mm max.

Largura: 26 mm max.

Se compone de punzones, matrices y peones de centrado.

Regulación simple del intervalo de los agujeros.

Ø de agujeros redondos:

1.00, 1.50, 2.00, 2.50 y 3.00 mm.

De otras formas bajo petición.

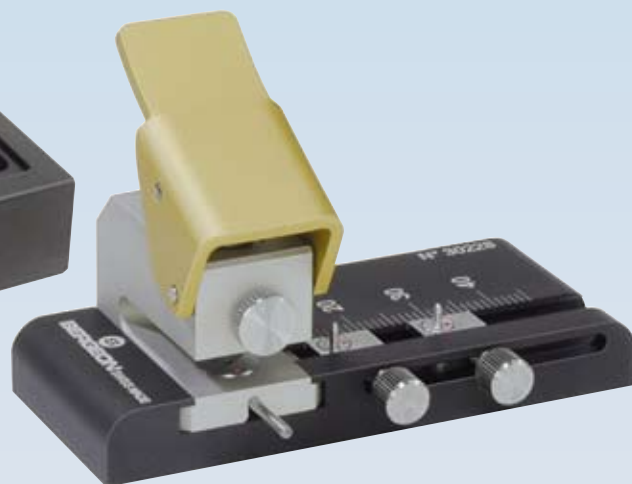
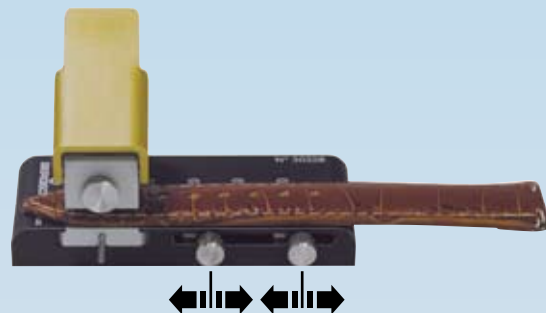

No 30228

320 gr.

Pce Fr.

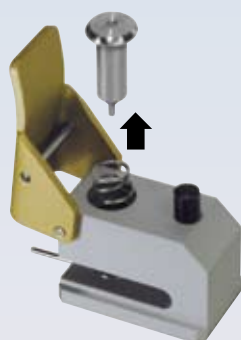

Changement rapide des poinçons et matrices.

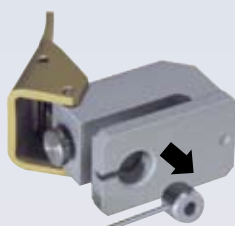

Schnelle änderung der Meißel und Matrizen.

Fast change of the punches and dies.

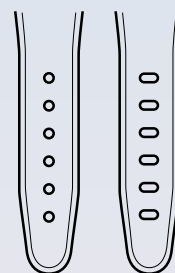

Cambio rápido de los punzones y matrices.



# BERGEON

Depuis 1791

Tél. + 41 32 933 60 00  
Fax + 41 32 933 60 01

www.bergeon.ch  
info@bergeon.ch

## Outil pour déchasser et chasser les goupilles de bracelets

L'outil permet de maintenir en bonne position les montres munies de bracelets métalliques afin de chasser et déchasser les goupilles de bracelet.

L'outil comporte divers ajustements permettant de centrer la goupille dans l'axe de la broche et est muni de dégagements pour l'évacuation des goupilles.

Protection caoutchouc sur la surface de travail.

Dimensions: 150 x 10 x 100 mm.

## Werkzeug zum Einpressen und Ausstossen der Armbandstifte

Das Werkzeug ermöglicht das Halten von Uhren mit Metallarmbändern in der gewünschten Stellung, um die Bandstifte einzupressen oder auszustossen.

Ausgestattet mit Auffangspalten für die Stifte weist das Werkzeug diverse Einstellmöglichkeiten auf, um die Bandstifte genau kozentrisch zum Ausstosstift anzuordnen.

Mit Gummischutz auf der Arbeitsfläche.

Masse: 150 x 10 x 100 mm.

## Tool to drive bracelet pins in and out

The tool is designed to maintain watches with metal bracelet in exact position to drive the pins in or out.

Equipped with enough space to enable the ejection of the pins, the pin's position can be adjusted in order to exactly align with the axis of the pin holder.

Rubber protection on top of working surface.

Dimensions: 150 x 10 x 100 mm.

## Útil para sacar y poner las clavijas de pulseras

Útil permite mantener en buena posición los relojes con pulseras metálicas para sacar y poner las clavijas de pulseras.

Con espacio suficiente para evacuar las clavijas, el soporte tiene diversos ajustamientos que permiten centrar todas las ranuras en el eje del porta clavijas.

Protección de caucho en la superficie de trabajo.

Medidas: 150 x 10 x 100 mm.

## MBA Swiss tool



No 7136

500 gr.

Pce Fr.



# BERGEON

Depuis 1791

Tél. + 41 32 933 60 00  
Fax + 41 32 933 60 01

www.bergeon.ch  
info@bergeon.ch

## Extracteurs HH pour lunettes tournantes

Poignée ergonomique en alu anodisé avec vis de réglage fin de butée pour éviter d'écraser la lunette.

Nouvelle bague en matière synthétique permettant l'extraction de tous types de lunettes tournantes sans griffer.

## HH Abheber für drehende Lünetten

Ergonomischer Griff in anodisiertem Aluminium mit Schraube zur Regulierung des Anschlages und Verhinderung dass die Lünette zerdrückt wird.

Neuer Ring in synthetischem Material zur Abhebung aller Arten von drehenden Lünetten ohne sie zu zerkratzen.

## HH extractors for rotating Bezels

Ergonomic handle in anodized aluminum with adjustable screw in end of banking to avoid crushing the Bezel.

New ring in synthetic material allowing the extraction of all kinds of rotating Bezels without scratching.

## Extractores HH de lunetas

Mango ergonómico en aluminio anodizado con tornillo de regulación para no atropellar la luneta.

Nueva anilla sintética para extracción sin rasguños de todo tipo de lunetas giratorias.

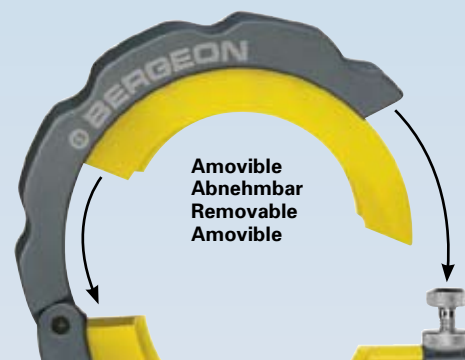
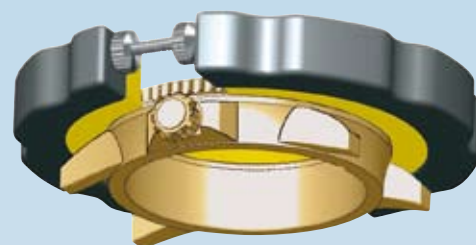

Assortiment de 6 pièces.

∅ intérieur de bague: 30 - 34 - 38 - 42 - 46 - 50 mm.

∅ extérieur de la poignée: 80 mm.

Sortiment von 6 Stück.

∅ inner Rings: 30 - 34 - 38 - 42 - 46 - 50 mm.

∅ äusserlich des Griffs: 80 mm.

Assortment of 6 pieces.

Interior ∅ of ring: 30 - 34 - 38 - 42 - 46 - 50 mm.

∅ external of the handle: 80 mm.

Surtidos de 6 piezas

∅ interior de anillo: 30 - 34 - 38 - 42 - 46 - 50 mm.

∅ exterior del punado: 80 mm.

No 7052

Pce Fr.

**Autres dimensions sur demande.**  
**Andere Dimensionen auf Antrag.**  
**Other dimensions on request.**  
**Otras dimensiones sobre demanda.**

Extracteurs seuls.  
Abheber allein.  
Only extractors.  
Extractores solo.

No 7052-...

Pce Fr.

Tél. + 41 32 933 60 00  
Fax + 41 32 933 60 01

**B**  
**BERGEON**  
D e p u i s 1 7 9 1

www.bergeon.ch  
info@bergeon.ch

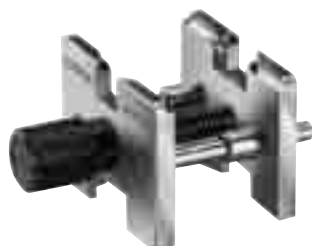

### Porte-pièce extensible et réversible

Pour calibres 3 3/4''' - 11''' . Nickelé et sablé.

### Dehn- und umkehrbarer Werkhalter

Für Kaliber 3 3/4''' - 11''' . Vernickelt und sandgestrahlt.

### Extensible and reversible movement holder

For calibres 3 3/4''' - 11''' . Nickelled and sanded.

### Porta-máquina extensible y reversible

Para calibres 3 3/4''' - 11''' . Niquelado y arenado.

 No 4039	32 gr.	Pce Fr.
---	--------	---------



### Porte-pièce extensible et réversible synthétique

Pour calibres 3 3/4''' - 11''' . Serrage sur Ø extérieur de 12 à 30 mm.

### Dehn- und umkehrbarer synthetischer Werkhalter

Für Kaliber 3 3/4''' - 11''' . Festklemmen auf Ø äußerlich von 12 bis 30 mm.

### Extensible and reversible synthetic movement holder

For calibres 3 3/4''' - 11''' . Tightening on Ø external from 12 to 30 mm.

### Porta-máquina extensible y reversible sintético

Para calibres 3 3/4''' - 11''' . Sujeción sobre Ø exterior de 12 a 30 mm.

 No 4039-P	13 gr.	Pce Fr.
---	--------	---------

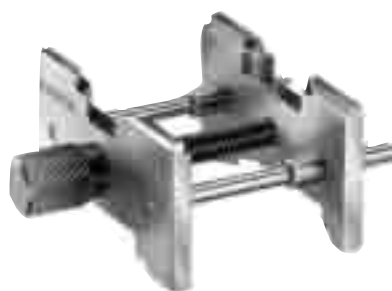

### Porte-pièce extensible et réversible

Pour calibres 8 3/4''' - 19''' . Nickelé et sablé.

### Dehn- und umkehrbarer Werkhalter

Für Kaliber 8 3/4''' - 19''' . Vernickelt und sandgestrahlt.

### Extensible and reversible movement holder

For calibres 8 3/4''' - 19''' . Nickelled and sanded.

### Porta-máquina extensible y reversible

Para calibres 8 3/4''' - 19''' . Niquelado y arenado.

 No 4040	40 gr.	Pce Fr.
---	--------	---------

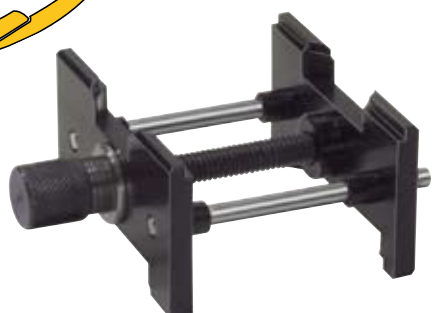

### Porte-pièce extensible et réversible synthétique

Pour calibres 8 3/4''' - 19''' . Serrage sur Ø extérieur de 30 à 48 mm.

### Dehn- und umkehrbarer synthetischer Werkhalter

Für Kaliber 8 3/4''' - 19''' . Festklemmen auf Ø äußerlich von 30 bis 48 mm.

### Extensible and reversible synthetic movement holder

For calibres 8 3/4''' - 19''' . Tightening on Ø external from 30 to 48 mm.

### Porta-máquina extensible y reversible sintético

Para calibres 8 3/4''' - 19''' . Sujeción sobre Ø exterior de 30 a 48 mm.

 No 4040-P	15 gr.	Pce Fr.
---	--------	---------





# BERGEON

Depuis 1791

Tél. + 41 32 933 60 00  
Fax + 41 32 933 60 01

www.bergeon.ch  
info@bergeon.ch

## JAXA ORIGINAL

Nouvelle clé spécialement développée pour ouvrir les fonds de boîtes vissés des montres de grandes dimensions.

Sa forme ergonomique assure une prise en main agréable et sûre.

**Diamètre d'ouverture de 18 mm à 62 mm.**

Neuer Schlüssel, entwickelt um grosse Gehäuse zu öffnen.

Seine ergonomische Form versichert eine angenehme Handhabung.

**Öffnungsdurchmesser 18 mm bis 62 mm.**

New Jaxa Key specifically designed to open case backs of large watches.

The ergonomic shape provide a firm and comfortable grip.

**Opens diameters from 18 mm to 62 mm.**

Nueva llave especialmente desarrollada para abrir los fondos de cajas atornillados de los relojes de grandes dimensiones.

Su forma ergonómica garantiza una toma en mano agradable y segura.

**Diámetros de abertura de 18 mm a 62 mm.**



 **SWISS MADE**  
Patent pending

No 2819-08

260 gr.

Pce Fr.



# BERGEON

Depuis 1791

Tél. + 41 32 933 60 00  
Fax + 41 32 933 60 01

www.bergeon.ch  
info@bergeon.ch

## Réchaud à température variable réglée

Boîtier électronique avec affichage digital double.

Surface utile 63 x 113 mm.

Capacité de chauffe progressive et précise jusqu'à 180°C.

Mémorisation de 2 températures de consigne.

100 - 250 VAC. 50/60 Hz.

Câble silicone, résistant à la chaleur.

Témoin lumineux de chauffe.

## Heizplatte mit regulierbarer Temperatur

Elektronikgehäuse mit doppelt digitaler Anzeige.

Arbeitsfläche 63 x 113 mm.

Heizleistung progressif und präzise bis 180°C.

Speicherung für 2 Soll-Temperaturen.

100 - 250 VAC. 50/60 Hz.

Kabel Silikon, Hitzwiderstandsfähig.

Lampe für Heizungswarnungs.

## Electric heater with adjustable temperature

Electronic case with double digital display.

Working surface of 63 x 113 mm.

Progressive and accurate heating up to 180°C.

The heater can memorize 2 pre-set temperatures.

100 - 250 VAC. 50/60 Hz.

Cable silicone, resistant to heat.

Led for warning of heating.

## Estufa de temperatura variable

Caja electrónica con visualización digital multiple.

Superficie útil 63 x 113 mm.

Capacidad de calefacción progresiva de precisión hasta 180°C.

Memorización de 2 temperaturas de consigna.

100 - 250 VAC. 50/60 Hz.

Cable silicona resistente al calor.

Testigo luminescente de calefacción.

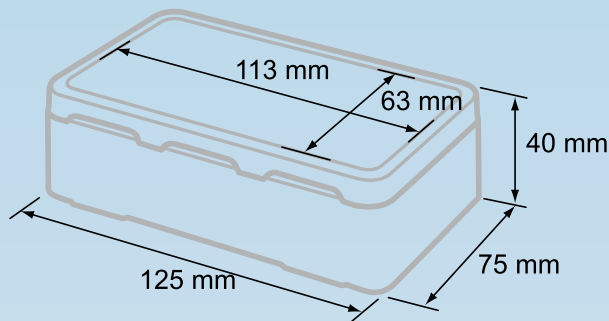

 SWISS MADE

No 7044

1.770 kg

Pce Fr.

## Réchaud à température variable réglée

Par potentiomètre.

100 - 250 VAC. 50/60 Hz.

## Heizplatte mit regulierbarer Temperatur

Durch regelbaren Spannungsleiter.

100 - 250 VAC. 50/60 Hz.

## Electric heater with adjustable temperature

By potentiometer.

100 - 250 VAC. 50/60 Hz.

## Estufa de temperatura variable

Por potenciómetro.

100 - 250 VAC. 50/60 Hz.

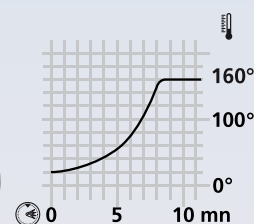

No 7044-V

377 gr.

Pce Fr.



# BERGEON

Depuis 1791

Tél. + 41 32 933 60 00  
Fax + 41 32 933 60 01

www.bergeon.ch  
info@bergeon.ch

## Assortiment de 15 fraises, en métal dur, à pivots interchangeables

Tige conique 2%.  
S'utilisent avec la broche 30007-C.  
Tous les pivots de l'assortiment sont interchangeables entre eux pour fraises No 1 à 12 + 16 et No 13 à 15.

Livré en étui bois.

## Satz von 15 Fräsern, in Hartmetall, mit auswechselbaren Zapfen

Konische Welle 2%.  
Verwendbar mit Brosche 30007-C.  
Alle Zapfen des Satzes sind untereinander auswechselbar für Fräser No 1 bis 12 + 16 und No 13 bis 15.

Geliefert im Holzetui.

## Assortment of 15 end-mill, in hard metal, with interchangeable pivots

Conical shank 2%.  
Use with broach 30007-C.  
All the pivots of the assortment are interchangeable between themselves for end-mill No 1 to 12 + 16 and No 13 to 15.

Delivered in wooden case.

## Surtido de 15 fresas, en metal duro, a pivotes intercambiables

Eje cónico 2%.  
Se utilizan con el husillo 30007-C.  
Todos los pivotes del surtido son intercambiables entre ellos para fresas No 1 - 12 + 16 y No 13 - 15.

Entregadas en estuche de madera.

30007-F-MD-...		30007-P-MD-...			30007-F-MD-...		30007-P-MD-...				
No	D mm	d mm	d1 mm		No	D mm	d mm	d1 mm			
1	130	1.30	060	0.60	0.50	7	310	3.10	120	1.20	0.50
2	160	1.60	070	0.70	0.50	8	340	3.40	130	1.30	0.50
3	190	1.90	080	0.80	0.50	9	370	3.70	150	1.50	0.50
4	220	2.20	090	0.90	0.50	10	400	4.00			
5	250	2.50	100	1.00	0.50	11	430	4.30			
6	280	2.80	110	1.10	0.50	12	450	4.50			
13	130	1.30	035	0.35	0.30	Hors assortiment - Nicht im Sortiment : d1 Ø 0.50 Not in assortment - No en el surtido					
14	160	1.60	040	0.40	0.30						
15	190	1.90	050	0.50	0.30						
						16	500	5.00	200	2.00	0.50

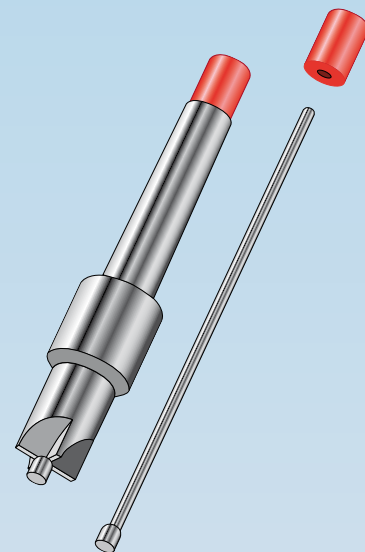

Broche - Brosche - Broach - Husillo



No 30007-C 12 gr. Pce Fr.

## Douilles d'arrêt - Arretierhülsen - Fixing sleeves - Casquillos de paro

d1		No 30007-DA50	1 gr.	d1 Ø 0.50 mm
d1		No 30007-DA30	1 gr.	d1 Ø 0.30 mm



No 30007-MD-S 659 gr. Pce Fr.

**NEW**

SWISS MADE

Socle seul - Aluminium  
Sockel allein - Aluminium  
Stand only - Aluminium  
Zócalo solo - Aluminio



Assortiment (Nos 1-15)  
Sortiment (Nrn 1-15)  
Assortment (Nos 1-15)  
Surtido (Nos 1-15)

No 30007-MD 110 gr. Pce Fr.

No 30007-MD-15 110 gr. Pce Fr.



# BERGEON

Depuis 1791

Tél. + 41 32 933 60 00  
Fax + 41 32 933 60 01

www.bergeon.ch  
info@bergeon.ch

**Assortiments de  
8 brucelles d'horlogerie**

**Sätze von 8 Kornzangen  
für die Uhrenindustrie**

**Sets of 8 tweezers  
for watch industry**

**Surtidos de  
8 pinzas de relojería**

 SWISS MADE

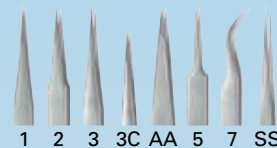

### Antimagnétiques

Très bonne résistance à la corrosion, aux produits acides et alcalins.

### Antimagnetisch

Sehr guter Widerstand auf Korrosion, Säuren und Alkali.

### Antimagnetics

Very good resistance to corrosion, acids and alkaline products.

### Antimagnéticos

Muy buena resistencia a la corrosión, a los productos ácidos y alcalinos.



No 7026

293 gr.

Pce Fr.



### Acier inoxydable

Magnétiques. Endurcies par traitement thermique, d'où des pointes très dures et fortes. Utilisées si une haute résistance à la corrosion n'est pas demandée.

### Edelstahl

Magnetisch. Gehärtet durch thermische Behandlung, daher sehr harte und starke Spitzen. Zu verwenden, wenn ein Korrosionswiderstand nicht gefragt ist.

### Stainless steel

Magnetics. Hardened by thermic treatment, therefore very hard and strong tips. Used if a high resistance to corrosion is not needed.

### Acero inoxidable

Magnéticos. Endurecidas por tratamiento térmico, de donde las puntas muy duras y fuertes. Utilizadas si una alta resistencia al corrosión non se pide.



No 7027

278 gr.

Pce Fr.



### Superalloy (Ni-Cr-Mo)

Très haute résistance thermique jusqu'à 800° C et six fois plus dure que l'acier inoxydable. 100% non-magnétique. Résistance à la corrosion, aux produits acides et alcalins.

### Superalloy (Ni-Cr-Mo)

Sehr hoher Temperaturwiderstand bis zu 800 Grad Celcius und sechsmal härter als Edelstahl. 100 % nicht magnetisch. Widerstand auf Korrosion, Säuren und Alkali.

### Superalloy (Ni-Cr-Mo)

Very high thermic resistance, up to 800°C and six times harder than stainless steel. 100% antimagnetic. Resistance to corrosion, acids and alkaline product.

### Superalloy (Ni-Cr-Mo)

Muy alta resistencia térmica asta 800° C y seis veces más duro que el acero inoxidable. 100% non magnético. Resistencia a la corrosión, a los productos ácidos y alcalinos.



No 7028

295 gr.

Pce Fr.





**Brucelles d'horlogerie**

**Uhrmacherkornzangen**



**Tweezers for watch industry**

**Pinzas de relojería**

 **SWISS MADE**

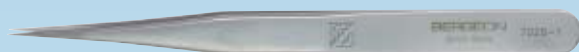

120 mm



	Antimagnetic	<b>No 7026-1</b>	15 gr.	Pce Fr.
	Inox	<b>No 7027-1</b>	14 gr.	Pce Fr.
	Superalloy	<b>No 7028-1</b>	26 gr.	Pce Fr.



120 mm



	Antimagnetic	<b>No 7026-2</b>	16 gr.	Pce Fr.
	Inox	<b>No 7027-2</b>	15 gr.	Pce Fr.
	Superalloy	<b>No 7028-2</b>	28 gr.	Pce Fr.



120 mm



	Antimagnetic	<b>No 7026-3</b>	15 gr.	Pce Fr.
	Inox	<b>No 7027-3</b>	14 gr.	Pce Fr.
	Superalloy	<b>No 7028-3</b>	27 gr.	Pce Fr.



110 mm



	Antimagnetic	<b>No 7026-3C</b>	13 gr.	Pce Fr.
	Inox	<b>No 7027-3C</b>	12 gr.	Pce Fr.
	Superalloy	<b>No 7028-3C</b>	24 gr.	Pce Fr.



110 mm



	Antimagnetic	<b>No 7026-5</b>	14 gr.	Pce Fr.
	Inox	<b>No 7027-5</b>	13 gr.	Pce Fr.
	Superalloy	<b>No 7028-5</b>	25 gr.	Pce Fr.



115 mm



	Antimagnetic	<b>No 7026-7</b>	15 gr.	Pce Fr.
	Inox	<b>No 7027-7</b>	14 gr.	Pce Fr.
	Superalloy	<b>No 7028-7</b>	27 gr.	Pce Fr.



130 mm



	Antimagnetic	<b>No 7026-AA</b>	18 gr.	Pce Fr.
	Inox	<b>No 7027-AA</b>	17 gr.	Pce Fr.
	Superalloy	<b>No 7028-AA</b>	30 gr.	Pce Fr.

140 mm



	Antimagnetic	<b>No 7026-SS</b>	14 gr.	Pce Fr.
	Inox	<b>No 7027-SS</b>	13 gr.	Pce Fr.
	Superalloy	<b>No 7028-SS</b>	25 gr.	Pce Fr.

**Hors assortiment**



**Nicht im Sortiment**

**Not in assortment**

**No en el surtido**



120 mm



	Antimagnetic	<b>No 7026-00</b>	14 gr.	Pce Fr.
	Inox	<b>No 7027-00</b>	13 gr.	Pce Fr.
	Superalloy	<b>No 7028-00</b>	25 gr.	Pce Fr.

110 mm



	Antimagnetic	<b>No 7026-4</b>	14 gr.	Pce Fr.
	Inox	<b>No 7027-4</b>	13 gr.	Pce Fr.
	Superalloy	<b>No 7028-4</b>	25 gr.	Pce Fr.



# BERGEON

Depuis 1791

Tél. + 41 32 933 60 00  
Fax + 41 32 933 60 01

www.bergeon.ch  
info@bergeon.ch

## Tissus pour un environnement à atmosphère contrôlée (salle blanche) Gewebe für Umwelt in der geprüften Atmosphäre (Reinraum) Wipers for environment in controlled atmosphere (clean room) Tejidos para medio ambiente con atmósfera controlada (sala blanca)

### Tissus cellulose/polyester

Spécialement adapté pour l'essuyage en général, pour petites et grandes surfaces.

#### Propriétés:

- non contaminant
- ne relargue pas de fibres
- jetable
- très absorbant.

#### Conditionnement:

**7037-100** livré par paquet de 1200 pièces  
**7037-230** livré par paquet de 300 pièces.

### Gewebe aus Zellstoff/Polyester

Besonders geeignet zum Abtrocknen, von kleinen und großen Oberflächen.

#### Eigenschaften:

- Nicht ansteckend
- Fuselfrei
- Wegwerfbar
- Grosse Saugkraft.

#### Verpackung:

**7037-100** Pakete zu 1200 Stück  
**7037-230** Pakete zu 300 Stück.

### Wipers Cellulose/Polyester

Especially adapted for wiping in general, for small and big surfaces.

#### Properties:

- Not contaminant
- Do not reject fibres
- Disposable
- Highly absorbent.

#### Packaging:

**7037-100** delivered by package of 1200 pieces  
**7037-230** delivered by package of 300 pieces.

### Tejidos celulosa/poliéster

Especialmente adaptado para limpieza de las superficies pequeñas y grandes.

#### Propiedades:

- No contaminan
- no se deshilachan
- desechable
- muy absorbente.

#### Acondicionamiento.

**7037-100** entregado por paquete de 1200 piezas  
**7037-230** entregado por paquete de 300 piezas.



100 x 100 mm	<b>No 7037-100</b>	1106 gr.	Pce Fr.
230 x 230 mm	<b>No 7037-230</b>	1180 gr.	Pce Fr.

### Tissus 100% polyester

Tissus lavé à l'eau déionisée, ultra-propre, pour salles blanches, catégorie ISO3.

#### Propriétés:

- non-contaminant
- ne relargue pas de fibres
- jetable
- moyennement absorbant.

**Conditionnement:** livré par paquet de 150 pièces.

### Gewebe 100% Polyester

In entionisiertem Wasser gewaschenes Gewebe ultrasauber, für Reinräume, Kategorie ISO3.

#### Eigenschaften:

- Nicht ansteckend
- Fuselfrei
- Wegwerfbar
- Mittelmässige Saugkraft.

**Verpackung:** Pakete zu 150 Stück.

### Wipers 100% Polyester

Wipers washed with deionised water, ultra-clean, for white rooms, category ISO3.

#### Properties:

- Not contaminant
- Do not reject fibres
- Disposable
- Fairly absorbent.

**Packaging:** Delivered by package of 150 pieces.

### Tejido 100% poliéster

Lavados al agua desmineralizada, ultralimpia, para salas blancas, categoría ISO3.

#### Propiedades:

- No contaminan
- no se dishalachan
- desechable
- bastante absorbente.

**Acondicionamiento:** entregado por paquete de 150 piezas.



230 x 230 mm	<b>No 7038</b>	590 gr.	Pce Fr.
--------------	----------------	---------	---------



# BERGEON

Depuis 1791

www.bergeon.ch  
info@bergeon.ch

Tél. + 41 32 933 60 00  
Fax + 41 32 933 60 01

## Tissus 100% microfibre

Recommandé spécialement pour l'essuyage des pièces ou composants en or très sensibles aux rayures ainsi que verres de montres avec anti-reflet.

### Propriétés:

- lavable à 40° C.
- non-contaminant
- ne relargue pas de fibres.

**Conditionnement:** livré par paquet de 100 pièce

## Gewebe 100% Mikrofaser

Besonders zum Abtrocknen von Gold Stücken kratzempfindlichen, sowie Antireflex Uhrgläsern.

### Eigenschaften:

- Bei 40°C waschbar
- Fuselfrei
- Nicht ansteckend.

**Verpackung:** Pakete zu 100 Stück

## Wipers 100% Microfibre

Especially recommended for the wiping of gold item or component highly sensitive to scratches as well as anti-reflecting watch glasses.

### Properties:

- Washable at 40°C
- Not contaminant
- Do not reject fibres.

**Packaging:** Delivered by package of 100 pieces

## Tejido 100% microfibra

Recomendado especialmente para el pulido de las piezas o los componentes de oro muy sensibles a las rayas así como los cristales de reloj con antireflejo.

### Propiedades:

- Lavable a 40 ° C.
- No contaminan
- no se deshilachan.

**Acondicionamiento:** entregado por paquete de 100 piezas.



230 x 230 mm    **No 7039**    786 gr.    Pce Fr.

## Tissus polypropylène

Pour tout nettoyage de pièces ou surfaces grasses, imbibé de 70% isopropyl, 30% eau déionisée.

### Propriétés:

- fort pouvoir dégraissant.
- tissu propre, pour cat. ISO3
- ne relargue pas de fibres
- jetable.

### Conditionnement:

livré par sachet de 50 pièces.

## Gewebe Polypropylene

Für jegliche Reinigung von fettigen Teilen oder Oberflächen.

Mit 70% Isopropyl und 30% deionisiertem Wasser angereichert.

### Eigenschaften:

- Stark entfettend
- Sauberes Gewebe, für Kat. ISO3
- Fuselfrei
- Wegwerfbar.

**Verpackung:** Pakete zu 50 Stück.

## Wipers Polypropylene

For cleaning of greasy piece surfaces, soaked with 70% isopropyl, 30% of deionised water.

### Properties:

- Strong grease-removing capacity
- Clean tissue for cat. ISO3
- Do not reject fibres
- Disposable.

**Packaging:** Delivered by package of 50 pieces.

## Toallitas polipropileno

Para toda la limpieza de las piezas o superficies grasas, prehumedecidas con 70% alcohol isopropilico y 30% agua desmineralizada.

### Propiedades:

- fuerte poder desengrasante
- Tejido limpio, para cat. ISO3
- no se deshilacha
- desechable.

**Acondicionamiento:** entregadas por paquete de 50 piezas.



230 x 280 mm    **No 7040**    455 gr.    Pce Fr.



# BERGEON

Depuis 1791

Tél. + 41 32 933 60 00  
Fax + 41 32 933 60 01

www.bergeon.ch  
info@bergeon.ch

## Tapis effeuillables bleus et blancs

Grâce à leur pouvoir adhésif élevé, les tapis effeuillables sont synonymes d'extrême propreté. Ils empêchent les agents contaminants présents sur les semelles de chaussures et les roulettes de chariots d'entrer dans la salle blanche ou d'autres zones de travail critiques.

### Tapis de base autocollant antidérapant:

- Faible épaisseur (env. 1,5 mm pour 30 couches.)
- Il n'est pas nécessaire de nettoyer le tapis: le film sale est simplement enlevé.
- La numérotation de chaque couche permet de constater rapidement le nombre de feuilles restantes.
- Les tapis doivent être stockés à plat pour éviter toute ondulation.

## Weisse und blauen Klebefolienmatten

Abziehbare Klebefolienmatten dienen aufgrund ihrer starken Haftwirkung zur Feinreinigung. Sie verhindern, dass die an Schuhsohlen und Wagenrädern haftenden Verunreinigungen in den Reinraum bzw. an kritische Arbeitsplätze eingebracht werden.

### Rutschfest durch selbstklebende Mattengrundlage:

- Geringe Mattenhöhe (ca. 1,5 mm bei 30 Lagen)
- Keine Reinigung notwendig, verschmutzte Folienlage wird einfach abgezogen
- Die einzelnen Folien sind nummeriert, um die verbleibenden Lagen jederzeit identifizieren zu können
- Die Teppiche müssen an Teller gelagert werden, um jede Welligkeit zu vermeiden.

## White and Blue Peel-off Carpets

Due to their strong adhesive effect, peel-off mats are used to pre-clean and to collect dust from the soles of shoes and trolley wheels. They prevent contaminants from entering the cleanroom or other critical working areas.

### Self-adhesive base prevents slipping:

- Low profile (approx. 1.5 mm for 30 layers)
- No cleaning necessary - dirty layers are simply peeled off
- Each layer is numbered, so the number of layers remaining is easily identified
- The carpets must be stored flat to avoid any undulation.















## Alfombras pelables blancas y azules

Gracias a su elevado poder adhesivo, las alfombras pelables son sinónimas de extrema limpieza. Impiden a los agentes contaminantes presentes sobre las suelas de zapatos y las ruedas de carros de entrar en la sala blanca o otras zonas de trabajo críticas.

### Alfombra de base autoadhesiva antiderrapante:

- Bajo espesor (aprox. 1,5 mm. por 30 hojas.) no es necesario limpiar la alfombra: se retira simplemente la película sucia
- La numeración de cada hoja permite saber rápidamente el número de hojas restantes
- Las alfombras deben almacenarse completamente para evitar toda ondulación.



	No		cm		Kg		Pce Fr.
	7041-114-W	30	114 x 66		10		
	7041-114-B						
	7041-117-W	30	117 x 91		14		
	7041-117-B						
	7041-152-W	30	152 x 89		16		
	7041-152-B						





## Distributeur de surchaussures

Développé spécialement pour les environnements où l'hygiène et la propreté sont une priorité.

Très utile et facile d'utilisation.

Indication des quantités restantes par affichage digital.

## Surchaussuresverteiler

Besonders entwickelt für die Umgebung, wo die Hygiene und die Sauberkeit eine Priorität sind.

Sehr nützlich und einfach von Benutzung.

Hinweis der übrig gebliebenen Quantitäten durch digitalen Anschlag.

## Automatic cover shoes machine

Developed especially for the environments where hygiene and cleanliness are a priority.

Very useful and easy to use.

Indication of the remaining quantities by digital posting.

## Distribuidor de sobrezapatos

Desarrollado especialmente para el medio ambiente donde la higiene y la limpieza son una prioridad.



Muy útil y fácil de utilización.

Indicación de las cantidades restantes por visualización digital.





### Recharges - Auffüllungen Refills - Recambios

#### Fines - Fein - Thin - Finas

No 7083-B-100	320 gr.		100x	Pce Fr.
No 7083-A-200	640 gr.		200x	Pce Fr.



#### Epaisses - Dick - Thick - Gruesas

No 7083-B-080	380 gr.		80x	Pce Fr.
No 7083-A-160	760 gr.		100x	Pce Fr.



**Antiglisse:** se met manuellement.



**Rutschfest:** stellt sich manuell.

**Antigrip:** puts itself manually

**Antideslizante:** se pone manualmente.



No 7083-110	17 Kg	Pce Fr.
No 7083-230	17 Kg	Pce Fr.

No 7083-C-050	200 gr.		50x	Pce Fr.
No 7083-C-100	300 gr.		100x	Pce Fr.

## Machine automatique à enlever les surchaussures

Capacité de récupération: 200 pièces.

## Automatische Maschine die Surchaussures

Wiedergewinnung wegzunehmen: 200 Stücke.

## Automatic take off machine

Capacity of recovery: 200 pieces.

## Máquina automática que debe retirarse los sobrezapatos

Capacidad de recuperación: 200 piezas.



No 7082-110	15 Kg	Pce Fr.
No 7082-230	15 Kg	Pce Fr.





**Sticks de nettoyage**

Disponibles en polyester et polyuréthane.  
Ces sticks polyvalents sont très résistants aux acides et solvants. Ils sont très propres grâce au processus de fabrication pour salle blanche donnant le taux le plus bas en contaminants ioniques et de particules non-volatiles. Ils sont idéaux pour des applications de nettoyage.  
Tige en polypropylène flexible. Longueur totale: 7 ~ 8 cm.

**Reinigungsstäbchen**

Erhältlich in ungewobenem oder gestricktem Polyester, diese Stäbchen sind Säure- und Lösungsmittelbeständig. Sie sind ideal zum Anwenden beim Reinigen oder Abtupfen mit schleifender Wirkung. Stab aus beweglichem Polypropylen. Gesamtlänge: 7 ~ 8 cm.

**Swabs for cleaning**

Available in polyester and polyurethane. These multifunctional sticks are very resistant against acids and solvents. Due to the clean room process of these products, the content of particle contaminants and non-volatile residue is extremely low. Ideal for cleaning purpose. Shaft in flexible polypropylene. Total length: 7 ~ 8 cm.

**Bastoncillos de limpieza**

Disponibles en poliéster y poliuretano. Estos bastoncillos polivalentes son muy resistentes a los ácidos y los disolventes. Son muy limpios gracias al proceso de fabricación para sala blanca dando el índice más bajo en contaminantes iónicos y de partículas no volátiles. Son ideales para aplicaciones de limpieza. Tija en polipropileno flexible. Longitud total: 7 ~ 8 cm.



Assortiment de 140 pièces (20 de chaque No).  
Satz von 140 Stücke (20 von jeder Nr).  
Assortment of 140 pieces (20 of each No).  
Surtido de 140 piezas (20 de cada No).



No 7007-S	56 gr.	Pce Fr.
-----------	--------	---------

Matière Material Material Materia	No	Forme Form Shape Forma	125 pces / Fr.
Mousse Polyuréthane scellée	7007-01		
	7007-02		
	7007-03		
Mousse Polyuréthane	7007-04		
Polyester scellé	7007-05		
	7007-06		
	7007-07		



# BERGEON

Depuis 1791

Tél. + 41 32 933 60 00  
Fax + 41 32 933 60 01

www.bergeon.ch  
info@bergeon.ch

## Blouse d'horloger antistatique

Trois poches, double col, fermeture avec boutons pression, cache-boutons pour ne pas endommager les établis, poignets réglables avec boutons pression.

Tissu mixte: 65% polyester, 33% coton et 2% carbone. Très légères et confortables, couleur blanche ou bleu ciel quadrillée avec trames de carbone. Logo brodé sur demande.

## Uhrmacherkittel antistatisch

3 Taschen, doppel Kragen, Druckknopfverschluss, Knöpfe verdeckt damit der Arbeitstisch nicht beschädigt wird, Manschetten mit Drücker regulierbar.

Gewebe aus: 65% Polyester, 33% Baumwolle und 2% Kohlenstoff. Sehr leicht und komfortabel, Farben weiss oder Himmelblau mit dunklen Streifen. Auf Wunsch mit gesticktem Logo.

## Antistatic coat for watchmaker

Three pockets, double collar, pressure buttons, masked buttons in order to protect the workbenches, adjustable wrists with pressure buttons.

Mixed fabrics: 65% polyester, 33% cotton and 2% carbon. Very light and comfortable, white color or clear blue with wefts of carbon. Embroidered Logo on demand.

## Bata de relojero antiestática

Tres bolsillos, cuello camisa, cierre frontal mediante corchetes, solapa para protección del puesto de trabajo, ajuste de mangas con corchetes.

Tejido mixto de 65% poliester, 33% algodón y 2% carbono. Muy ligeras y confortables, color blanco o azul claro con cuadrados de carbono. Logotipo bordado posible.



Tailles  
Größen  
Sizes  
Tallas  
XXS-XS-S-M-L-XL-XXL

○	●	gr.	Pce Fr.	○	●	gr.	Pce Fr.
7084-W XXS	7084-B XXS	335		7084-W L	7084-B L	355	
7084-W XS	7084-B XS	340		7084-W XL	7084-B XL	360	
7084-W S	7084-B S	345		7084-W XXL	7084-B XXL	365	
7084-W M	7084-B M	350					

## Blouse de travail

Pour horlogers, bijoutiers. 3 poches, poche de poitrine avec compartiments pour crayons. 3 boutons à pression. Tissu mixte: 65% polyester, 35% coton. Couleur blanche. Fabrication Suisse.

## Arbeitskittel

Für Uhrmacher und Juweliere. 3 Taschen, Brusttasche mit abgestepften Bleistiftfächern. 3 Druckknöpfe. Mischgewebe: 65% Polyester, 35% Baumwolle. Farbe: weiss. Schweizer Herstellung.

## Overall

For watchmakers and jewellers. 3 pockets, breast pocket stitched in divisions for pencils. 3 press buttons heat fixed. Mixed material: 65% polyester, 35% cotton. Colour: white. Swiss made.

## Bata de trabajo

Para relojeros, joyeros. 3 bolsillos, bolsillo de pecho con divisiones para lapiceros. 3 botones a presión. Tejido mixto: 65% polyester, 35% algodón. Color: blanco. Fabricación suiza.



Tour de poitrine Brustumfang Chest size Vuelta de pecho cm	No	Poids Gewicht Weight Peso gr.	Pce Fr.
84	5983-42	410	
88	5983-44	420	
92	5983-46	430	
96	5983-48	440	
100	5983-50	450	
104	5983-52	460	
108	5983-54	470	
112	5983-56	480	

Tél. + 41 32 933 60 00  
Fax + 41 32 933 60 01

**B**  
**BERGEON**

www.bergeon.ch  
info@bergeon.ch

by Smile Line ☺



### The Cube

Layette de table en aluminium avec 5 tiroirs garnis pour le rhabillage.

Schubladenstock bestückt mit 5 Schubladen für Uhrenreparatur.

Aluminium Cube with 5 furnished drawers. For repairing.

"Layette" mueble con cajones en aluminio con 5 cajones surtidos para la compostura.

No 7014-G-V3	2.700 kg	Pce Fr.
--------------	----------	---------

**PREMIUM**

#### Tiroir gris, mousse noire







#### Graue Schublade, schwarzer Schaum





#### Gray drawer, black foam

#### Cajón gris, espuma negra

No 7014-G-T11	270 gr.	Pce Fr.
---------------	---------	---------

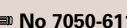
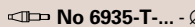
 No 7062 - Ø 5 mm -  No 7063-T... - Ø 0.50, 0.60, 0.80, 1.00, 1.20, 1.40, 1.60, 2.00 mm.  
 No 7063 - Ø 9 mm -  No 7063-... - Ø 0.50, 0.60, 0.80, 1.00, 1.20, 1.40, 1.60, 2.00 mm.



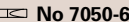

No 7014-G-T12	260 gr.	Pce Fr.
---------------	---------	---------

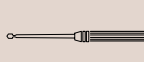
 No 7027-1, 7027-3, 7027-5 -  No 7050-611  
 No 6935-T... - Ø 0.60, 1.20, 1.50, 1.60 mm. -  No 7050-601-01 -  No 7050-602-01  
 No 7050-612 -  No 7050-610



No 7014-G-T13	490 gr.	Pce Fr.
---------------	---------	---------

 No 7060 - Ø 0.60, 0.80, 0.90, 1.00 mm. -  No 7061-... - Ø 0.18, 0.24, 0.32, 0.45 mm.

No 7014-G-T14	310 gr.	Pce Fr.
---------------	---------	---------

 No 5935 -  No 6988-T... - Ø 0.70, 0.80, 0.90, 1.00, 1.20 mm. -  No 7050-609-...  
 No 7050-60

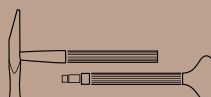
No 7014-G-T15	380 gr.	Pce Fr.
---------------	---------	---------

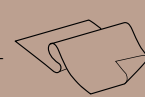
 No 1442 -  No 7857 -  No 6850-2-JS



**Lanières en cuir  
pour le transport**

**Schmale Riemen aus  
Leder für den Transport**

**Leather thin straps  
for transport**

**Correas de cuero  
para el transporte**



No 7014-L1

190 gr.

Pce Fr.



No 7014-L2

157 gr.

Pce Fr.





# BERGEON

by Smile Line ☺

Tél. + 41 32 933 60 00

Fax + 41 32 933 60 01

www.bergeon.ch

info@bergeon.ch

### ...innovation

Lorsqu'une nouvelle idée surgit, il est à notre avis fondamental de la soumettre à deux questions essentielles qui valideront sa matérialisation ou au contraire seront synonymes de son abandon:

- L'idée est-elle innovatrice?
- Est-ce qu'elle va réellement apporter un avantage à l'utilisateur final?

Seuls les concepts qui peuvent répondre par l'affirmative à ces deux questions auront une chance de voir le jour chez nous.

Parce qu'ils ne sont pas juste des variantes à des solutions connues, nos articles deviennent régulièrement de nouvelles références ou tendances dans leur domaine spécifique. C'est probablement pour cette raison que nos clients sont toujours impatients de découvrir nos nouvelles créations.

### ...design

«Le design est plus qu'étroitement lié à la fonction – il en est indissociable». Depuis le début de l'aventure Smile Line en 1994, nous nous attachons à respecter ce concept incontournable pour chaque nouveau produit.

Après l'étude de faisabilité et le choix des options de fabrication, commence le véritable travail de création: choix des matériaux, étude des formes, de l'ergonomie.

Mis bout à bout, ces éléments font ce pour quoi nos outils et accessoires sont des objets uniques et exclusifs à forte valeur ajoutée.

### ...exclusivité

A l'heure où l'industrie ne parle que de globalisation et de productivité, chez Smile Line c'est la passion qui nous fait avancer. Une passion indéfectible qui nous permet d'entrer dans les moindres détails afin de vous offrir les outils et les accessoires les plus en harmonie avec votre travail quotidien.

Smile Line est totalement en marge de la production de masse et nos produits d'exception vous permettent non seulement de vous simplifier la vie et de gagner du temps en toute sécurité, ils sont aussi porteurs d'émotion et vous procurent un sentiment d'exclusivité totale.

### ...Innovation

Wenn eine neue Idee auftaucht, finden wir es als fundamental wichtig die Frage zu stellen, lohnt sich eine Realisierung oder lassen wir es:

- ist die Idee innovativ?
- bringt sie wirklich einen Vorteil für den Anwender?

Nur Ideen welche auf diese Fragen positiv ausfallen, haben eine Chance von Smile Line realisiert zu werden.

Unsere neuen Artikel sind nicht einfach Veränderungen von üblichen Produkten, sondern setzen in ihrem Bereich neue Maßstäbe... Wahrscheinlich ist das der Grund, wieso unsere Kunden immer gespannt und ungeduldig unsere neuen Kreationen entdecken wollen.

### ...Design

Das Design ist mehr als nur ein wichtiger Bestandteil der Funktion – Design und Funktion sind unzertrennlich... Seit der Gründung von Smile Line 1994 bemühen wir uns diesen Grundgedanken zu beachten und auf jedes neues Produkt umzusetzen.

Nach sorgfältiger Prüfung der Machbarkeit beginnt die wirkliche Arbeit: Wahl der Materialien, Formgebung, Ergonomie.

Zusammengefügt, bilden diese Elemente den Grund, warum unsere Instrumente und Utensilien einzigartige und exklusive Gegenstände mit einem hohen Wert sind...

### ...Exklusivität

Seit geraumer Zeit spricht die Industrie nur von Globalisierung und Produktivität.

Bei Smile Line ist es die Leidenschaft die uns vorwärts bringt.

Eine unvergängliche Leidenschaft die uns auf die kleinsten Details eingehen lässt, damit wir ihnen die besten Instrumente und Accessoires für die tägliche Arbeit anbieten können.

Smile Line ist weit entfernt von Massenproduktion. Unsere aussergewöhnlichen Produkte machen ihr Leben nicht nur leichter durch Zeitgewinn, sondern wecken Emotionen und vermitteln einen Hauch Exklusivität.

### ...innovation

When a new idea rises, in our opinion it is fundamental to expose it to the two main questions which will validate either its materialization or its withdrawal:

- Is the idea innovative?
- Does it really give an advantage to the end user?

Only those concepts which positively match these two questions will have a chance to come from Smile Line.

Because they are not just variants to existing solutions, our items regularly become new reference items and trends in their segments. This is more often than not the reason why our customers are always eager to discover our new creations.

### ...design

“Design is more than closely tied to function – it is indivisible from it”

Since the inception of Smile Line in 1994, we have respected the innate concept for each new product. After the study of feasibility and the choice of manufacturing options, then starts the real work of creation: choice of materials, study of forms, volumes and ergonomics.

Put together, these elements make the reason why our tools and accessories are unique and exclusive objects with a high added value.

### ...exclusivity

While the whole industry talks only about globalisation and productivity, it is passion that makes us go forward. An unflinching passion that allows us to take into consideration the smallest details in order to offer you the tools and accessories which provide an experience more in harmony with your every day work.

Smile Line is totally on the fringe of mass production and our exceptional products make your life easier, save time and to be more confident. At the same time, they are vectors of emotions and bring you a unique feeling of exclusivity.

### ...innovación

Cuando una nueva idea surge, en nuestra opinión es fundamental exponerla a las dos preguntas principales que validarán ya sea su materialización o su retiro:

- Es la idea innovadora?
- Realmente le da una ventaja al usuario final?

Solamente aquellos conceptos que corresponden a esas dos preguntas tendrán una oportunidad de venir de Smile Line.

Porque no son solo variantes de soluciones existentes, nuestros ítems regularmente se vuelven nuevos ítems de referencia y tendencias en sus segmentos. Esto es más frecuente si no la razón de lo por qué nuestros clientes están siempre expectantes por descubrir nuestras nuevas creaciones.

### ...diseño

«El diseño es mas que cercanamente atado a la función – es indivisible de esta»

Desde el inicio de Smile Line en 1994, hemos respetado el concepto innato de cada nuevo producto. Después del estudio de factibilidad y la selección de opciones de fabricación, entonces empieza el verdadero trabajo de creación: selección de materiales, estudio de formas, volúmenes y ergonomía.

Juntados, estos elementos conforman la razón de por qué nuestras herramientas y accesorios son objetos únicos y exclusivos con un alto valor agregado.

### ...exclusividad

Mientras toda la industria habla solamente de globalización y productividad, es la pasión que nos hace ir hacia delante. Una inquebrantable pasión que nos permite tener en consideración los mas pequeños detalles con el fin de ofrecerle las herramientas y accesorios que proveen una experiencia mas en armonía con su trabajo de cada día.

Smile Line está totalmente al margen de la producción en masa y nuestros excepcionales productos hacen de su vida más fácil, ahorradora de tiempo, y más confiable. Al mismo tiempo, son vectores de emociones y le brindan una sensación única de exclusividad.





# BERGEON

by Smile Line ☺

www.bergeon.ch  
info@bergeon.ch

Tél. + 41 32 933 60 00  
Fax + 41 32 933 60 01

## The Cube

Layette de table en aluminium massif.

Cette petite layette est extrêmement compacte (150 x 150 x 150 mm).

Elle est conçue pour y ranger le petit outillage ou autres fournitures nécessaires au quotidien de l'horloger ou du microtechnicien.

Son concept modulaire permet de sélectionner différents types de tiroirs comportant les mousses spécifiques découpées à la géométrie de leur contenu, mais aussi des tiroirs standard comportant de petits casiers à fournitures.

Notre département de développement des produits se porte à votre disposition pour des géométries de mousses spécifiques à vos outils ou à toute autre personnalisation esthétique.

## The Cube

Tischschubladenschränckchen in massivem Aluminium.

Dieses kleine Schubladenschränckchen ist ausserordentlich kompakt (150 x 150 x 150 mm).

Es ist entwickelt für kleines Werkzeug und anderen Furnituren des täglichen Gebrauchs der Uhrmacher oder Mikromechaniker.

Sein auswechselbares Konzept ermöglicht es unter verschiedenen Schubladentypen ausgerüstet mit Schaumstoff geometrisch je nach Inhalt ausgeformt, oder auch Standardladen mit kleinen Unterteilungen für Furnituren auszuwählen.

Unsere Abteilung der Produktentwicklung steht Ihnen zur Verfügung für die Ausarbeitung der speziellen Schaumstoffformen oder anderen persönlichen Wünschen.

## The Cube

Nest of Drawers in massive aluminium.

This small nest of drawers is extremely compact (150 x 150 x 150 mm).

It is conceived to put away small tools or other furniture used daily by the watchmaker or the micro-technician.

Thanks to its modular concept, you can select various type of drawers which contain specific foams cut out to the geometry of their contents but, also standard drawers with small racks for supplies.

Our Product Development Department is at your disposal for specific foams at the geometry of your tools or for any other esthetic personalization

## The Cube

"Layette" meuble con cajones en aluminio masivo.

Esta pequeña layette es extremadamente compacta (150x150x150mm).

Se concibe para guardar la pequeña herramienta o otros suministros necesarios para el diario del relojero o el micro técnico.

Su concepto modular permite de seleccionar distintos tipos de cajones que implican las espumas específicas recortadas a la geometría de su contenido, y también de los cajones normales implicando pequeños casilleros a suministros.

Nuestro departamento de desarrollo de los productos se eleva a su disposición para geometrías de espumas específicas a sus herramientas o a cualquier otra personalización estética.



No 7014-N

990 gr.

Pce Fr.

No 7014-G

990 gr.

Pce Fr.



**BERGEON**

by Smile Line ☺

Tél. + 41 32 933 60 00  
Fax + 41 32 933 60 01

www.bergeon.ch  
info@bergeon.ch

**Version 1**

Comprenant les tiroirs T01 - T03 - T04 - T06 - T08 - T09.

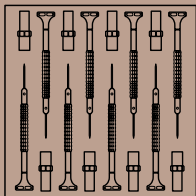

**Version 1**

Erfasst die Schubladen T01 - T03 - T04 - T06 - T08 - T09.

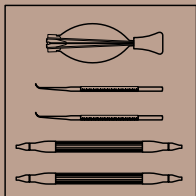

**Version 1**

Including the drawers T01 - T03 - T04 - T06 - T08 - T09.

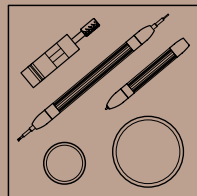

**Versión 1**

Incluyendo los cajones T01 - T03 - T04 - T06 - T08 - T09.

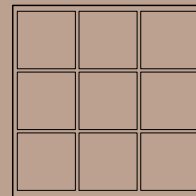
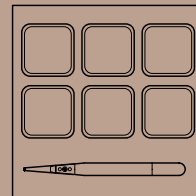

● **No 7014-N-V1** 2.390 kg Pce Fr.

● **No 7014-G-V1** 2.390 kg Pce Fr.



**Version 2**

Comprenant les tiroirs 3 x T09 et 3 x T10.

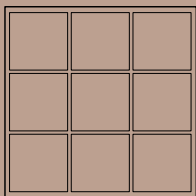

**Version 2**

Erfasst die Schubladen 3 x T09 und 3 x T10.

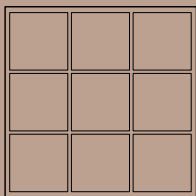

**Version 2**

Including the drawers 3 x T09 and 3 x T10.

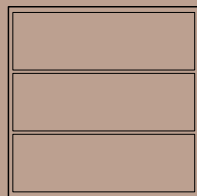

**Versión 2**

Incluyendo los cajones 3 x T09 y 3 x T10.



● **No 7014-N-V2** 2.050 kg Pce Fr.

● **No 7014-G-V2** 2.050 kg Pce Fr.



**BERGEON**

by Smile Line ☺

www.bergeon.ch  
info@bergeon.ch

Tél. + 41 32 933 60 00  
Fax + 41 32 933 60 01



Tiroir noir, mousse noire - Schwarze Schublade, schwarzer Schaum  
Black drawer, black foam - Cajón negro, espuma negra.

Tiroir gris, mousse noire - Graue Schublade, schwarzer Schaum  
Gray drawer, black foam - Cajón gris, espuma negra.



**No 7014-N-T01** 220 gr. Pce Fr.



**No 7014-G-T01** 220 gr. Pce Fr.

 **No 6899-...** - Ø 0.50, 0.60, 0.80, 1.00, 1.20, 1.40, 1.60, 2.00 mm.  
 **No 6899-T-...** - Ø 0.50, 0.60, 0.80, 1.00, 1.20, 1.40, 1.60, 2.00 mm.



**No 7014-N-T02** 240 gr. Pce Fr.

**No 7014-G-T02** 240 gr. Pce Fr.





 **No 6988-...** - Ø 0.70, 0.80, 0.90, 1.00, 1.20 mm.  
 **No 30080-T-...** - Ø 0.70, 0.80, 0.90, 1.00, 1.20 mm.

 **No 30106-D** -  **No 4000**



**No 7014-N-T03** 230 gr. Pce Fr.

**No 7014-G-T03** 230 gr. Pce Fr.

 **No 30636-1**       **No 7050-601-1**  
 **No 30018 (2 x)**       **No 7050-601-2**



**No 7014-N-T04** 240 gr. Pce Fr.

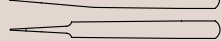
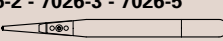

**No 7014-G-T04** 240 gr. Pce Fr.

 **No 7026-1 - 7026-2 - 7026-3 - 7026-5**  
 **No 7026-F** -  **No 6571-E**



**No 7014-N-T05** 200 gr. Pce Fr.



**No 7014-G-T05** 200 gr. Pce Fr.

 **No 7013-...** - Ø 0.18, 0.24, 0.32, 0.45 mm. -  **No 6885-...** - Ø 6, 8, 10, 12 mm.

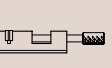

**No 7014-N-T06** 320 gr. Pce Fr.

**No 7014-G-T06** 320 gr. Pce Fr.

 **No 5394-P** -  **No 4721** -  **No 6876**  
 **No 7050-604**       **No 7050-602-S**



**No 7014-N-T07** 240 gr. Pce Fr.



**No 7014-G-T07** 240 gr. Pce Fr.

 **No 6901-TBPR-120**  
 **No 6901-AR-...** &  **No 6895-...** Ø 0.50, 0.60, 0.80, 1.00, 1.20, 1.40, 1.60, 2.00 mm.



**No 7014-N-T08** 210 gr. Pce Fr.

**No 7014-G-T08** 210 gr. Pce Fr.

 **No 6571-E** -  **No 6799-01 (6 x)**



**No 7014-N-T09** 180 gr. Pce Fr.

**No 7014-G-T09** 180 gr. Pce Fr.

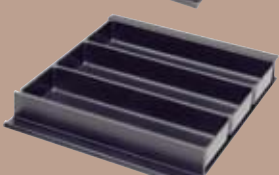

**No 7014-N-T10** 180 gr. Pce Fr.

**No 7014-G-T10** 180 gr. Pce Fr.



# BERGEON

by Smile Line ☺

Tél. + 41 32 933 60 00  
Fax + 41 32 933 60 01

www.bergeon.ch  
info@bergeon.ch

## Instruments

## Instrumente

## Instruments

## Instrumentos

### No 7050-602-F:

Outil aux barettes, pointes fines  
Federstegwerkzeug, feinen Spitzen  
Spring-bars tool, fine points  
Útil para barritas, puntas finas

### No 7050-602-S:

Outil aux barettes, pointes standard  
Federstegwerkzeug, Standard Spitzen  
Spring-bars tool, standard points  
Útil para barritas, puntas standard

### No 7050-604:

Outil correcteur,  
pointe synthétique  
Korrekturwerkzeug,  
synthetische Spitze  
Correcting Tool,  
with synthetic tip  
Herramienta correctora  
de punta sintética



### No 7050-603:

Outil aux barettes, avec pointe,  
fourchette en forme de spatule  
Federstegwerkzeug, mit Spitze,  
Gabel in Spachtelform  
Spring-bars tool, with point,  
spatula-shaped fork  
Útil para barritas, con punta,  
horquilla en forma de espátula

### No 7050-601-1:

Pose-aiguille:  
Nadelhalter:  
Fitting Needles:  
Colocar las agujas:



### No 7050-601-2:

Pose-aiguille:  
Nadelhalter:  
Fitting Needles:  
Colocar las agujas:



### No 7050-609-120: ●

Chasse-goupilles  
Stift-Austreiber  
Pin extractors  
Sacapasadores



### No 7050-609-100: ●

### No 7050-609-090: ●

### No 7050-609-080: ●

### No 7050-609-070: ●



**BERGEON**

by Smile Line ☺

www.bergeon.ch  
info@bergeon.ch

Tél. + 41 32 933 60 00  
Fax + 41 32 933 60 01

**Instruments**

**Instrumente**

**Instruments**

**Instrumentos**



**No 7050-608:**  
Marteau  
Hammer  
Hammer  
Martillo



**No 7050-606:**  
Loupe  
Lupe  
Magnifying glass  
Lupa



**No 7050-605:**  
Pinceau de dépeussière  
Entstauberpinsel  
Duster Brush  
Pincel de desempolvadura

**Instruments**  
Modules de base

**Instrumente**  
Basis module

**Instruments**  
Basic modules

**Instrumentos**  
Modulos base



**No 7050-101-C:** Manche court aluminium - Aluminium kurzer Griff - Short Aluminium Handle - Mango corto aluminio



**No 7050-201-C:** Manche court en ébène - Kurzer Griff in Ebenholz - Short Ebony Handle - Mango corto en ébano



**No 7050-301-C:** Manche court en bois de violette - Kurzer Griff in Veilchenholz - Short Handle in kingwood - Mango corto en amarante



**No 7050-401-C:** Manche court en palissandre - Palisanderholzgriff, kurz - Short Purple Wood Handle - Mango corto en palisandro



**No 7050-101**



**No 7050-201**



**No 7050-301**



**No 7050-401**



**No 7050-609-2:**  
Douille bombée  
Hülse gewölbt  
Convex sleeve  
Casquillo abombado

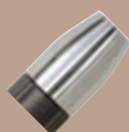

**No 7050-604-2:**  
Douille creuse  
Hohle Hülse  
Hollow sleeve  
Casquillo hueca

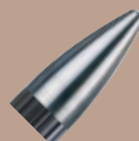

**No 7050-4000-BS:**  
Douille borgne courte  
Hülse mit Blindloch, kurz  
Short obstructive sleeve  
Casquillo ciego corto



**No 7050-4000-B:**  
Douille borgne  
Hülse mit Blindloch  
Obstructed sleeve  
Casquillo ciego













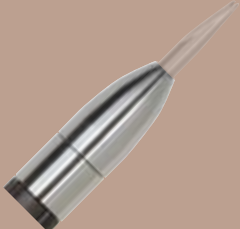



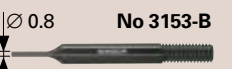
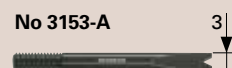
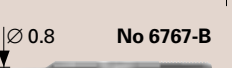
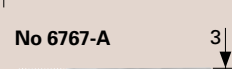
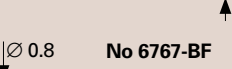

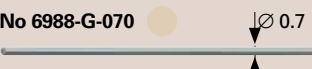

Tél. + 41 32 933 60 00  
Fax + 41 32 933 60 01

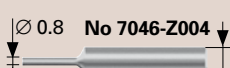
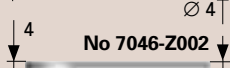
# BERGEON

www.bergeon.ch  
info@bergeon.ch

by Smile Line ☺

Modules sans embout	Modulen ohne Einsatz	Modules without tips	Módulos sin puntas																					
 <p><b>No 7050-601-0-1:</b> Module Pose-aiguille Nadelhalter Modul Fitting Needles Modul Modulos Colocar las agujas</p>	 <p><b>No 7050-602-0-1:</b> Module pointes vissées Geschraubtes Modul Modul with screwed tip Modulos Herramienta puntas atornilladas</p>	 <p><b>No 7050-609-120-0:</b> ● <b>No 7050-609-100-0:</b> ● <b>No 7050-609-090-0:</b> ● <b>No 7050-609-080-0:</b> ●</p> <p><b>No 7050-609-070-0:</b> ● Module chasse-goupilles Stift-Austreiber Modul Modul pin extractors Modulos sacapasadores</p>	 <p><b>No 7050-603-0-1:</b> Module pointes indexées Modul für angezeigten Spitzen Modul for indexed tips Modulos para puntas indexadas</p>																					
<p>Tasseaux pour aiguilles Einsätze für Zeiger Stakes for hands Tases para agujas</p>  <p>ØB ØA</p> <table border="1"> <thead> <tr> <th></th> <th>Ø A mm</th> <th>Ø B mm</th> </tr> </thead> <tbody> <tr> <td>6935-T-160 ●</td> <td>2.60</td> <td>1.60</td> </tr> <tr> <td>6935-T-120 ●</td> <td>2.10</td> <td>1.20</td> </tr> <tr> <td>6935-T-060 ●</td> <td>1.70</td> <td>0.60</td> </tr> </tbody> </table>  <p>ØA</p> <table border="1"> <thead> <tr> <th></th> <th>Ø A mm</th> <th>Ø B mm</th> </tr> </thead> <tbody> <tr> <td>6935-TP-260 ●</td> <td>2.60</td> <td>-</td> </tr> <tr> <td>6935-TP-150 ●</td> <td>1.50</td> <td>-</td> </tr> </tbody> </table>		Ø A mm	Ø B mm	6935-T-160 ●	2.60	1.60	6935-T-120 ●	2.10	1.20	6935-T-060 ●	1.70	0.60		Ø A mm	Ø B mm	6935-TP-260 ●	2.60	-	6935-TP-150 ●	1.50	-	<p>Pointes de rechange Ersatzspitzen Spare points Puntas de recambio</p> <p>Ø 0.8 <b>No 3153-B</b></p>  <p><b>No 3153-A</b> 3</p>  <p>Ø 0.8 <b>No 6767-B</b></p>  <p><b>No 6767-A</b> 3</p>  <p>Ø 0.8 <b>No 6767-BF</b></p>  <p><b>No 6767-AF</b> 1</p> 	<p>Goupilles à déchasser Ausstosstifte Pins Clavijas</p> <p><b>No 6988-G-070</b> ●</p>  <p>Ø 0.7</p> <p><b>No 6988-G-080</b> ●</p>  <p>Ø 0.8</p> <p><b>No 6988-G-090</b> ●</p>  <p>Ø 0.9</p> <p><b>No 6988-G-100</b> ●</p>  <p>Ø 1.00</p> <p><b>No 6988-G-120</b> ●</p>  <p>Ø 1.20</p>	<p>Pointes de rechange réversible et fourchette spatule Umkehrbarer Ersatzspitzen und Gabel in Spachtelform Spare reversible points and spatula-shaped fork Reversible puntas de recambio y horquilla en forma de espátula</p> <p>Ø 0.8 <b>No 7046-Z004</b></p>  <p>Ø 4</p> <p><b>No 7046-Z002</b></p>  <p>Ø 4</p> 
	Ø A mm	Ø B mm																						
6935-T-160 ●	2.60	1.60																						
6935-T-120 ●	2.10	1.20																						
6935-T-060 ●	1.70	0.60																						
	Ø A mm	Ø B mm																						
6935-TP-260 ●	2.60	-																						
6935-TP-150 ●	1.50	-																						
 <p><b>No 7050-604-0-1:</b> Module outil correcteur pointe synthétique Korrekturwerkzeug Modul, synthetische Spitze Correcting Tool modul with synthetic tip Modulos herramienta correctora de punta sintética</p>	 <p><b>No 7050-604-P:</b> Pointe de rechange pour correcteur Korrektur Ersatzspitze Correction replacement tip Punta de recambio corrector + <b>No 30080-X:</b> </p>	 <p><b>No 7050-4000-U:</b> Module marteau Hammermodul Hammer unit Módulo martillo</p>																						



**BERGEON**

by Smile Line ☺

www.bergeon.ch  
info@bergeon.ch

Tél. + 41 32 933 60 00  
Fax + 41 32 933 60 01

Pinceau	Pinsel	Brush	Pinsel
---------	--------	-------	--------



**No 7050-4000-KR:**  
Pinceau Kolinski No 8-R  
Pinsel Kolinski No 8-R  
Brush Kolinski No 8-R  
Pinsel Kolinski No 8-R

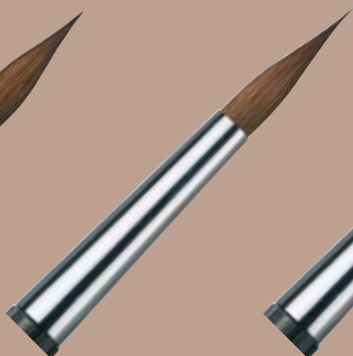

**No 7050-4000-KLT:**  
Pinceau Kolinski No 8-LT  
Pinsel Kolinski No 8-LT  
Brush Kolinski No 8-LT  
Pinsel Kolinski No 8-LT

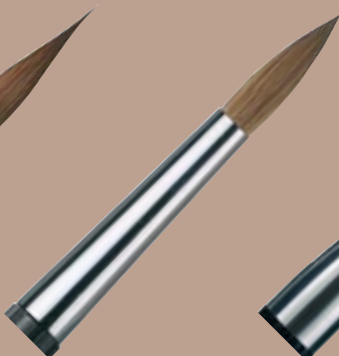

**No 7050-4000-KBig:**  
Pinceau Kolinski No 8-BIG  
Pinsel Kolinski No 8-BIG  
Brush Kolinski No 8-BIG  
Pinsel Kolinski No 8-BIG



**No 7050-4000-VD:**  
Pinceau DUST  
Staubpinsel  
DUST Brush  
Pinsel DUST



**No 7050-4000-LC:**  
Pinceau correction No 5  
Korrekturpinsel No 5  
Correcting Brush No 5  
Pinsel de corrección No 5

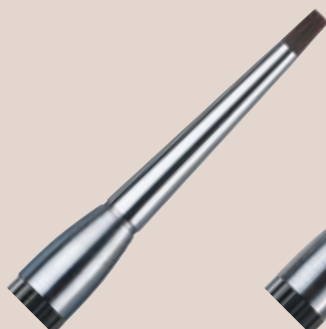

**No 7050-4000-LO:**  
Pinceau opaque large  
Opaker Pinsel, breit  
Large opaque brush  
Pinsel opaco largo

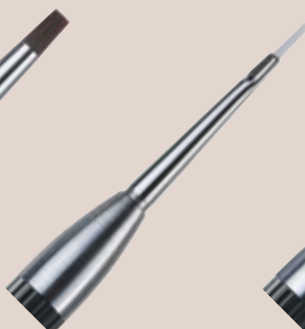

**No 7050-4000-M:**  
Pinceau opaque  
Opaker Pinsel  
Opaque brush  
Pinsel opaco

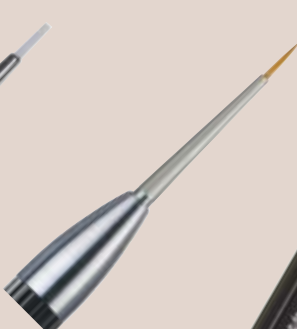

**No 7050-4000-SYO:**  
Pinceau Syntec No 0  
Pinsel Syntec No 0  
Syntec No 0 brush  
Pinsel Syntec No 0

**Divers**

**Divers**

**Divers**

**Divers**



**No 7050-1500**  
Accoudoirs ergonomiques  
Ergonomischen Armstützen  
Ergonomics arm rest  
Apoya-brazos ergonómico  
2 pcs/Stuck



**No 7050-6010:**  
The Golden Proportion



# BERGEON

by Smile Line ☺

Tél. + 41 32 933 60 00  
Fax + 41 32 933 60 01

www.bergeon.ch  
info@bergeon.ch

## Outils universels et couteaux

## Universelle Werkzeuge und Messer

## Universal tools and knives

## Herramientas universales y cuchillos



### No 7050-4000-OP1:

Instrument opaque petit,  
bille AI202

Kleines, opakes Instru-  
ment Kugel AI202

Small opaque Tool ball AI202

Instrumento opaco  
pequeña bola AI202

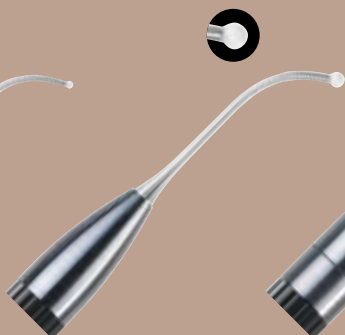

### No 7050-4000-OP2:

Instrument opaque grand,  
bille AI202

Grosses, opakes Instrument  
Kugel AI202

Big opaque Tool ball AI202

Instrumento opaco grande  
bola AI202



### No 7050-4000-CS:

Module scalpel

Skalpelmodul

Scalpel unit

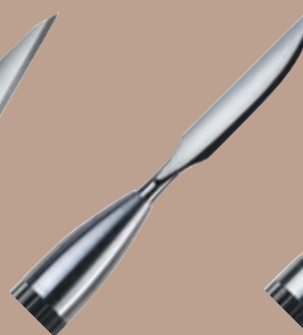

### No 7050-4000-D:

Lecron

Lecron

Lecron

Lecron



### No 7050-4000-E:

Lame

Klinge

Blade

Cuchillas



### No 7050-4000-F:

Spatule

Spachtel

Spatula

Espatula

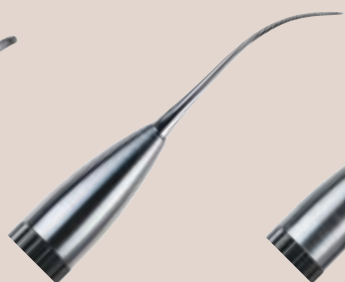

### No 7050-4000-J:

Aiguille

Nadel

Needle

Aguja



### No 7050-4000-S:

Beale spatule

Beale Spachtel

Beale Spatula

Beale espatula



### No 7050-8500-1:

295 x 180 x 2 mm

### No 7050-8500-2:

600 x 371 x 2 mm

**Sous-mains.** Matériau proche du néoprène, il offre un excellent grip.  
Très doux au toucher et très facile à nettoyer.

**Arbeitsunterlage.** Sehr angenehme ähnlich neopren Stoff,  
der einen ausgezeichneten Halt bietet.  
Sehr weich und leicht zu benutzen.

**Bench top.** Material very close to Neopren, offers an excellent  
grip. Smooth and soft. Easy to clean with a humid towel.

**Carpeta.** Material negro muy cercano al Neopreno ofrece un  
excelente agarre, es liso y suave.

Muy fácil de limpiar con una toalla húmeda.

## Support

## Träger

## Support

## Soporte

### 7050-4002:

Support de table  
(livré sans instruments)

Tischständer (ohne Instrumente)

Instrument bench stand  
(supplied without instruments)

Soporte para Mesón  
(entregado sin instrumentos)

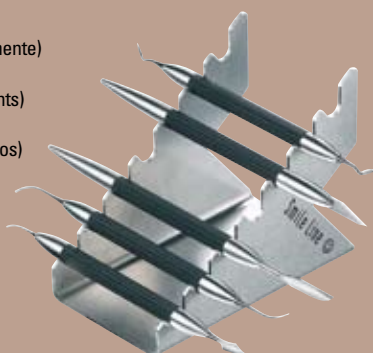

### No 7050-8100:

Support en aluminium pour fraises,  
tiges Ø 2.35 mm (livré sans fraises)

Aluminium Bohrerständer,  
Schaft Ø 2.35 mm (ohne Fräser geliefert)

Solid aluminium burstand,  
shank Ø 2.35 mm (delivered without burs)

Soporte sólido en aluminio,  
tijas Ø 2.35 mm (entregado sin fresas).



# BERGEON

Depuis 1791

Tél. + 41 32 933 60 00  
Fax + 41 32 933 60 01

www.bergeon.ch  
info@bergeon.ch

### Etabli Comfort

Etabli d'horloger avec réglage électrique de la hauteur, armature thermolaquée, grande surface de travail en bois massif avec rigole pour éviter la perte de petites pièces.

Le plateau de travail peut être ajustée entre 90 et 136 cm et être équipé de divers kit vacuum.

En option, les tiroirs sont également disponibles avec le verrouillage central.

### Werkstisch Comfort

Uhrmacherwerkstisch mit elektrischer Höhenverstellung, pulverbeschichtetem Gestell und grosser Massivbuchenholzarbeitsplatte mit kleinteil-Auffangfräsung.

Die grosse Arbeitsfläche kann stufenlos von 90 auf 136 cm verstellt werden und verfügt über variabel einstellbare Armauflagen.

Optional lassen sich die Schubladensäulen auch mit Vol্লাuszug und Zentralverriegelung ausstatten.

### Work Bench Comfort

Watchmaker bench with electric height adjustment, powdercoated frame and large, solid wood work surface with collecting grooves for small parts.

The large work surface can be adjusted between 90 and 136 cm and is equipped with variable arm sets.

As option, the drawers are also available with central locking with full-pull-out.

### Banco de trabajo Comfort

Banco del relojero con el ajuste de altura eléctrico, el marco powdercoated y la superficie de trabajo de madera grande, sólida con la recogida de los surcos para las pequeñas piezas.

La superficie de trabajo grande se puede ajustar entre 900 y 1360 milímetros y se equipa de los sistemas variables del brazo.

Como opción, los cajones están también disponibles con la fijación central.

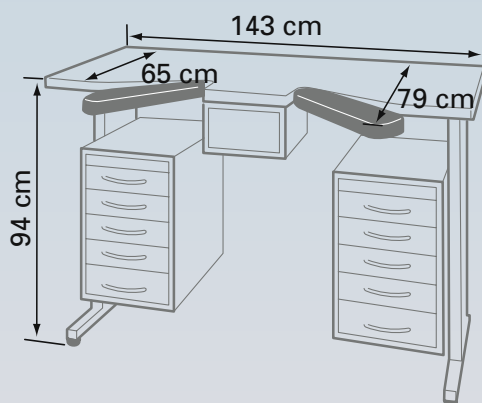

No 7862

145 kg

Pce Fr.

## Flux laminaire

Module à flux laminaire vertical.  
Bâti en tôle thermolaqué, parois latérales et de fond en plexiglas.

### Fonctionnement inaudible.

Commande/contrôle du ventilateur intégré permettant une régulation constante du débit.

Modification de la vitesse du flux d'air par programmation.

Préfiltre EU4 côté aspiration.

Filtre HEPA H14.

Interrupteur ON/OFF/REDUIT.

Vitesse frontale: 0.3 m/s.

Consommation environ 80 W.

Luminaire incorporé 30 W.

## Absaugaufsatz

Modell mit vertikalem Saugstrom für Anwendung im Reinraum.

Gebaut in Blech thermolaqué, Seitenwandstreben und des Plexiglasgrundes.

### Gehörlose Funktion.

Kontrollschalter der die Regulierung der eingebauten Ventilation ermöglicht.

Einstellbare und programierbare Luftausstossung.

Vorfilter auf Saugseite EU4.

Filter HEPA H14.

Schalter: EIN / AUS / STAND BY.

Frontale Saugstärke: 0.3 m / Sek.

Verbrauch ca. 80 W.

Einverlebte Beleuchtung 30 W.

## Clean Air Circuit

Vertical Clean Air Circuit Modul. Answers the conditions of use in clean room.

### Inaudible functioning.

Command / control of the integrated ventilator allowing a constant regulation of the air flow.

Modification of the flow's speed by programming.

Prefilter EU4, aspiration side.

Filter HEPA H14.

ON/OFF/STAND BY Switch.

Frontal speed: 0.3 m/s.

Approximate consumption 80 W.

Built-in luminary 30 W.

## Flujo de aire laminar

Cabina de flujo vertical.

Chasis en aluminio termolacado, paredes en plexiglass.

### Funcionamiento inaudible.

Pedido/control del ventilador integrado que permite un reglamento constante de la producción.

Modificación de la velocidad del flujo por programación.

Filtro de entrada EU4 en aspiración.

Filtro de salida HEPA H14

Interruptor ON/OFF/Reducido

Velocidad del flujo: 0.3m/s

Consumición: 80 W.

Alumbrado incorporado 30 W.

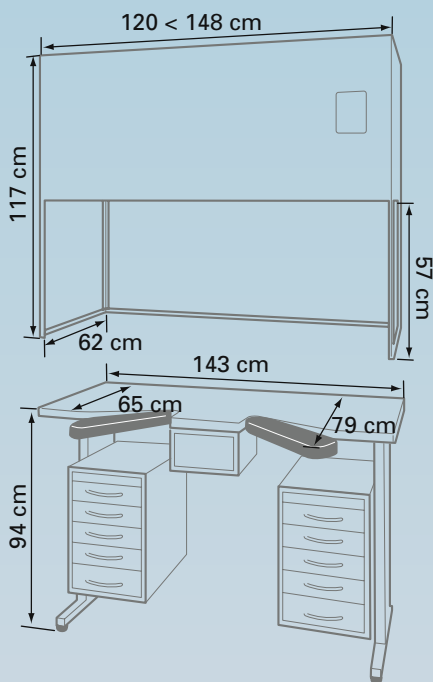

Dimensions adaptées à chaque type d'établi.  
Abmessungen, die jeden Werkbanktyp angepasst sind.  
Dimensions adapted to each type of work bench.  
Dimensiones adaptadas a cada tipo de banco de trabajo.



Modèle illustré - Illustriertes Modell - Illustrated model - Modelo ilustrado, 110 V.

Modèle illustré - Illustriertes Modell - Illustrated model - Modelo ilustrado, 230 V.

Etabli - Werk Tisch - Workbench - Banco de trabajo.

No 7862-FL-110	60 kg	Pce Fr.
No 7862-FL-230	60 kg	Pce Fr.
No 7862	Voir au verso - Siehe an der Rückseite See with the back - Ver al reverso	





# BERGEON

Depuis 1791

Tél. + 41 32 933 60 00  
Fax + 41 32 933 60 01

www.bergeon.ch  
info@bergeon.ch

## Polisseuse nouvelle génération Vario

Pour utilisation droitier et gaucher.

### 1 poste de travail.

Fabrication suisse.

Complètement carénée en tôle d'acier, recouverte de vernis plastifié très résistant.

Nombre de tours réglable par **variateur électronique**.

Aspiration et d'éclairage incorporé indépendant.

Protection pivotante en plexi.

Volet latéral mobile.

Bac de récupération en acier inox.

Fixation des accessoires **sur axe conique**.

### Livrée avec:

- 1 porte meule conique No 6880-HD
- 1 filtre jetable No 6699-D
- 1 tube néon No 6666-E
- 1 clef à fourche (17 mm)

### Caractéristiques techniques:

Moteur **couple constant** de 0.5 CV

Courant: 1.7 A

Conforme aux **normes CE**.

Ø de meules **maxi 200 mm.**

Accessoires: ☎ 5071 C.

## Vario Poliergeräte neue Generation

Für Benutzung rechtshändig und Linkshänder.

### 1 Arbeitsplatz.

Schweizer Fabrikat.

Komplett mit Stahlblech verkleidet, Anstrich mit hoch widerstandsfähigem plastifiziertem Schutzlack.

Anzahl der Umdrehungen kann über **elektronischen Drehzahlregler** gesteuert werden. Getrennt eingebauter Absauger und Beleuchtung.

Drehbare Schutzvorrichtung aus Plexiglas. Seitlicher beweglicher Staubabfänger. Auffangwanne aus nichtrostendem Stahl. Befestigung der Zusatzteile auf **konischer Achse**.

Drehbare Schutzvorrichtung aus Plexiglas. Seitlicher beweglicher Staubabfänger. Auffangwanne aus nichtrostendem Stahl. Befestigung der Zusatzteile auf **konischer Achse**.

Drehbare Schutzvorrichtung aus Plexiglas. Seitlicher beweglicher Staubabfänger. Auffangwanne aus nichtrostendem Stahl. Befestigung der Zusatzteile auf **konischer Achse**.

### Lieferung mit:

- 1 konischen Verlängerungsstück Nr. 6880-HD
- 1 Wegwerffilter Nr. 6699-D
- 1 Neon-Röhre Nr. 6666-E
- 1 Gabelschlüssel

### Technische Eigenschaften:

Motor mit **konstantem Drehmoment** von 0,5 CV

Strom: 1.7 A

Gemäß **CE-Richtlinie**.

**Scheiben Ø max. 200 mm.**

Zubehörteile: ☎ 5071 C.

## New generation compact polishing unit Vario

For use right- and left-handed person

### 1 work place.

Made in Switzerland.

Completely housed in steel plate, with very resistant plasticized coating.

Machine speed in rpm is controlled by an **electronic variator**.

Independent dust collection and incorporated lighting.

Plexiglass pivot-mounted guard. Sliding side plate.

Stainless steel collection case.

Accessories attached on **conical arbor**.

### Supplied with:

- 1 conical arbor No 6880-HD
- 1 disposable dust filter No 6699-D
- 1 neon tube No 6666-E
- 1 open-end wrench (17 mm)

### Technical characteristics:

**Constant torque** motor, 0.5 hp

Current: 1.7 A

Complies with **CE standard**.

**Max. arbor Ø: 200 mm.**

Accessories: ☎ 5071 C.

## Pulidora nueva generación Vario

Para utilización diestro y zurdo.

### 1 puesto de trabajo.

Fabricación suiza.

Completamente carenada en chapa de acero, recubierta de barniz plastificado muy resistente.

Número de vueltas regulable por **variador electrónico**.

Aspiración y luz incorporada independiente.

Protección pivotante de plexiglás. Postigo lateral móvil. Bandeja de recuperación de acero inoxidable.

Fijación de los accesorios en un **eje cónico**.

Fijación de los accesorios en un **eje cónico**.

### Se entrega con:

- 1 porta-muela cónico No 6880-HD
- 1 filtro desechable No 6699-D
- 1 tubo de neón No 6666-E
- 1 llave de horquilla (17 mm)

### Características técnicas:

Motor par **constante** de 0,5 CV

Corriente: 1.7 A

Conforme a la **norma CE**.

Ø de muelas **máximo 200 mm.**

Accesorios: ☎ 5071 C.



6890-G-220







 SWISS MADE

**NEW**



6890-D-220

Combinaison pour 2 postes - Kombination für 2 Posten  
Combination for 2 stations - Combinación para 2 puestos.

No	 Kg	rpm			L/P/H mm.		
6890-G-220	26	0 / 3600	410 m <sup>3</sup> /h	4W	500 x 430 x 390	220 V - 50 Hz - 0,2/0,3 kW	Pce Fr.
6890-D-220	26	0 / 3600	410 m <sup>3</sup> /h	4W	500 x 430 x 390	220 V - 50 Hz - 0,2/0,3 kW	Pce Fr.



# BERGEON

Depuis 1791

Tél. + 41 32 933 60 00  
Fax + 41 32 933 60 01

www.bergeon.ch  
info@bergeon.ch

## Nouveau micromoteur professionnel

**idéal pour vos travaux d'usinage.**

Le micromoteur TopSpin est un appareil de haute qualité technique pour l'ébavurage, le meulage, le polissage et autres travaux similaires. Il est utilisé dans l'industrie, dans la fabrication d'outils et la construction de moules, la fabrication de maquettes, ainsi qu'en bijouterie. L'appareil réunit de manière optimale fonction et design.

La commande se fait, comme sur un écran tactile, par l'intermédiaire de commutateurs capacitifs intégrés. Ceux-ci sont absolument inusables. En option, il est possible de régler la vitesse sans paliers grâce à un régulateur à pédale.

TopSpin se caractérise par une construction d'une solidité exceptionnelle de tous les composants, qui sont réalisés en matériaux de grande qualité.

Il est possible de commander deux différents types de pièces à main avec le même boîtier de commande.

Vous évitez ainsi le changement d'outil permanent.

Pince de serrage et jeu d'outils pour le diamètre de 2.35 mm ou 3 mm.

## Neue professioneller Handsleifspindel

**Volltreffer für Ihre Metallbearbeitung.**

Die Handsleifspindel TopSpin ist ein technisch hochwertiges Gerät für das Entgraten, Schleifen, Polieren und ähnliche Arbeiten. Eingesetzt wird sie in der Industrie, im Werkzeug- und Formenbau, im Modellbau sowie in der Schmuckherstellung. Das Gerät vereint Funktion und Design in optimaler Weise.

Die Bedienung erfolgt - ähnlich wie bei einem Touchpanel - direkt auf der Frontplatte aus Glas über integrierte kapazitive Schalter. Diese sind absolut verschleissfrei.

Als Option kann die Drehzahl stufenlos über einen Fussregler eingestellt werden.

Der TopSpin zeichnet sich aus durch überdurchschnittlich stabile Konstruktion aller Komponenten sind aus hochwertigen Materialien.

Bei Bedarf kann das Gerät mit einem zweiten Handstück nachgerüstet werden.

Sie vermeiden damit ständigen Werkzeugwechsel.

Spannzange und Werkzeugset für Durchmesser 2.35 mm oder 3 mm.

## New professional microgrinder

**A direct hit for your metal processing works.**

The microgrinder TopSpin is a technically highquality apparatus for burring, grinding, polishing and similar jobs. It is employed in industry, in tool and mould manufacture, in pattern and jewellery making. The apparatus optimally combines function and design.

The apparatus is operated - similar to a touch panel - directly on the glass front panel by means of integrated proximity switches. These are absolutely resistant to wear.

As an option, the speed can be continuously adjusted by means of a variable-speed foot rheostat.

TopSpin features an above-average stable construction of all components of high-quality materials.

The apparatus can be retrofitted with a second handpiece if desired.

You will thus avoid constant tool change.

Collet and tool set for diameter 2.35 or 3 mm.

## Nuevo micromotor profesional

**Ideal para elaboración.**

El micromotor Topspin es de alta calidad técnica para desrebabar, amolar y pulir.

Es utilizado en la industria dentro de la fabricación de herramientas, construcción de moldes y bisutería. Reúne de manera optimal función y diseño.

Los ajustes se hacen al igual que una pantalla táctil a través de comutadores capacitivos integrados. Estos últimos son absolutamente inusables.

En opción se puede variar la velocidad en continuo gracias a un regulador a pedal.

Topspin se caracteriza por una elaboración y una robustez excepcional de todos sus componentes que son realizados en materiales de gran calidad.

Posibilidad de pedir dos diferentes tipos de piezas a mano con el mismo mando de control.

De este modo se evita el cambio de herramientas permanentemente.

Pinza de sujeción y juego de herramientas para diámetros de 2.35 mm o 3 mm.

0.017 Nm  Ø 2.35 - 3.00 mm

No 7160-A-230

6.400 Kg

Pce Fr.

  
**BERGEON**  
by **LEHMANN**®  
präzision 





# BERGEON

Depuis 1791

www.bergeon.ch  
info@bergeon.ch

Tél. + 41 32 933 60 00  
Fax + 41 32 933 60 01

## Kit

- 1 Boîtier de commande - Steuergerät - Controller - Mando de control
- 1 Pièce à main - Handstück - Handpiece - Pieza de mano
- 1 Câble de connexion - Verbindungskabel - Cableconnexion - Cable de conexión
- 2 Pincettes de serrage - Spannzangen - Collet - Pinzas de sujeción  
Ø 2.35 et - und - and - y Ø 3 mm
- 1 Support pour pièce à main - Handstückablagen - Handpiece cradles -  
Soporte para pieza de mano
- 5 Fraises et 5 meules - 5 HM-Fräser und 5 Schleifstifte - 5 twheels and 5 cutters -  
5 fresas y 5 muelas ESP
- 1 Câble de raccordement - Anschlußkabel - Connecting cable - Cable de conexión
- 2 Outils pour changement des pincettes - Werkzeug für Spannzangenwechsel für  
Spannzangenwechsel - Tools for collet change - Herramienta para cambiar pinzas
- 1 Clé à ergot - Hakenschlüssel - Sickle spanner - Llave a espigón
- 1 Instructions de service - Handbuch - Instructions boock - Instrucciones de servicio

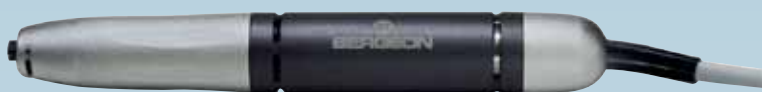

7160-01

En option  
In Option  
En opción



Desserrage et serrage de la pince  
Öffnen und schliessen der Zange  
Loosing and tightening of the pliers  
Aflojamiento y sujeción de la pinza

Dévisage de la pince  
Entschrauben der Zange  
Unscrewing of the pliers  
Destornillamiento de la pinza

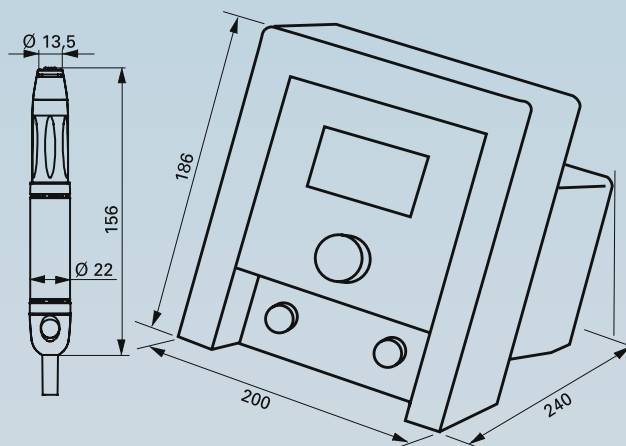

## Caractéristiques techniques

## Technische Daten

## Technical data

## Características técnicas

### Boîtier de commande - Steuergerät - Controller - Mando de control

Régulation de la vitesse - Drehzahlregulierung - Speed regulation - Regulación de la velocidad  
Alimentation - Netzanschluss - Main supply - Voltage  
Poids - Gewicht - Weight - Peso

3.000 < 50.000 rpm  
230 VAC  
6.1 kg

### Pièce à main - Handstück - Handpiece - Pieza de mano

Pince de serrage - Spannzange - Collet - Pinza de sujeción  
Poids - Gewicht - Weight - Peso  
Tension de service - Betriebsspannung - Operating voltage - Voltage  
Puissance continue - Dauerleistung - Permanent output - Potencia continua

Ø 2.35 ou - oder - or Ø 3 mm  
300 g  
36 VDC max.  
60 W



# BERGEON

Depuis 1791

Tél. + 41 32 933 60 00  
Fax + 41 32 933 60 01

www.bergeon.ch  
info@bergeon.ch

## Sableuse d'atelier

Petit modèle d'atelier avec cabine en polymère moulé; permet différentes finitions satinées sur toutes les surfaces métalliques.

Buse fixe en céramique auto-nettoyante.

Manipulation aisée des pièces à sabler.

### Avantages du système :

- Machine légère, fiable et compacte.
- Permet l'usage de différents sables (microbilles de quartz, alumine, silice, bronze, etc.)
- Idéal pour le rhabillage de boîtes de montres, bracelets, bijoux, etc.
- Machine "Cost effective".

### Caractéristiques principales :

- Manchons permettant de travailler avec des gants "nitriles".
- Buse de sablage fixe en céramique, remplaçable.
- Régulateur de pression 10 bars avec manomètre.
- Pédale de commande pneumatique.
- Substrat de sablage en circuit fermé avec filtre à particules fines.
- Système d'éclairage froid intégré.

Modèle 115 ou 220 V.

## Werkstatt Sandstrahlgeräte

Kleines Werkstatt Modell mit Geraümige Kabine aus Polymer; erlaubt unterschiedliche seidenmatte Polierung auf allen metallischen Oberflächen.

Selbstreinigende Keramikstrahldüse.

Zuverlässig und sehr praktisch für Teilen die bestrahlt sollen werden.

### Vorteile des Systems :

- leichte, zuverlässige und kompakte Maschine.
- Ermöglicht die Verwendung von verschiedenen Sanden (Mikrokügelchen aus Quarz, Aluminiumoxid, Siliziumdioxid, Bronze, usw.)
- Ideal für Uhrengehäuse, Armbänder, Schmuck, usw.
- Kostgünstige Maschine.

### Haupteigenschaften :

- Handlicher Griff, die mit Nitril-Handschuhen zu arbeiten erlauben.
- Auswechselbarer Keramik-Strahldüse.
- Regelbarer Arbeitsdruck mit Manometer, 10 bar.
- Fusschaltersteuerung
- Sandsubstrat mit Kreislaufsystem und Microfilter.
- Beleuchtungssystem integriert.

Modell 220 oder 115 V.

## Sand blaster

Small workshop unit with polymer cabinet; allows different satin finishes on all metal surfaces.

Self-cleaning ceramic nozzle.

Easy handling of pieces to be gritted.

### Advantages of the system :

- Light, reliable and compact unit.
- Allows use of several sands (Microballs of quartz, alumina, silica, bronze, etc.)
- Ideal for fine repairs of watch cases, bracelet, jewels, etc.
- "Cost effective" unit.

### Main characteristics :

- Sleeves allowing to work with nitriles gloves.
- Replacable sanding ceramic nozzle.
- Pressure regulator 10 bars with manometer.
- Foot pedal control.
- Sanding substrat in closed circuit with fine particules filter.
- Integrated cold lighting system.

Modèle 115 or 220 V.

## Soplador de arena para talleres

Modelo reducido de taller con cabina en polímero moldeado, permite distintos acabados satinados sobre todos tipos de superficies metálicas.

Tubo fijo en cerámica autolimpiable.

Fácilita la manipulación de las piezas que deben arenarse.

### Ventajas del sistema :

- Máquina ligera, fiable y compacta.
- Permite el uso de distintas arenas (micro-bolas de cuarzo, alumina, sílice, bronce, etc...).
- Ideal para la compostura de cajas de relojes, pulseras, joyas, etc.
- Máquina "Cost effective".

### Características principales :

- Mangas que permiten trabajar con guantes "nitriles".
- Tubo arenador fijo en cerámica, intercambiable.
- Regulador de presión 10 bares con manómetro.
- Pedal de mando neumático.
- Substrato de arenado en circuito cerrado con filtro a partículas finas.
- Sistema de alumbrado frío integrado.

Modelo 115 ó 220 V.

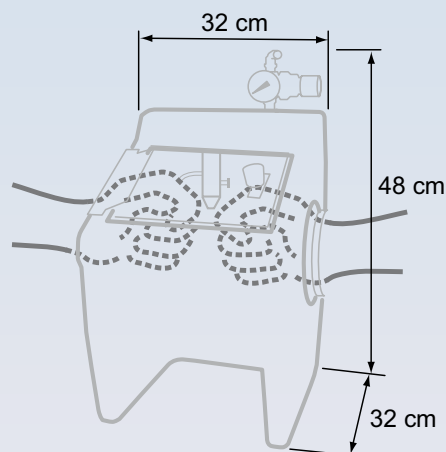

No 7069

4.250 Kg

Pce Fr.





# BERGEON

Depuis 1791

Tél. + 41 32 933 60 00  
Fax + 41 32 933 60 01

www.bergeon.ch  
info@bergeon.ch

## Microscope numérique

Conçu et dessiné pour un usage professionnel, le microscope numérique très compact effectue toutes prises de vue photos et vidéos en temps réel. Zoom grossissant jusqu'à 200 x.

Mesures: lignes, angles, diamètres et rayons ainsi que calibration.

### Application

- Contrôle qualité et secteur industriel
- Service Après-vente
- Téléconférences techniques
- Recherches et sciences

### Informatique

- Windows Vista, XP, 2000, Mac
- Lecteur CD-ROM
- Intel Pentium 4 1.5GHz ou plus rapide (Dualcore)
- RAM: minimum 256 MB
- DD: minimum 150MB d'espace libre
- Carte VGA: 16-bit ou plus
- Interface USB: 2.0 recommandé (longueur cable ~180 cm).

## Numerisches Mikroskop

Zum professionellen Gebrauch. Das sehr kompakte numerische Mikroskop erstellt scharfe Aufnahmen ( Photos und Videos) auch bei Zeitgleiche und besitzt einen Zoom bis zu 200X Vergrößerung des Bildes.

Die Messmöglichkeiten, zum Beispiel: Linien, Winkeln, Durchmesser und Halbmessern sowie Kalibrieren sind keine zu verschmähen Vorteile dieses kleinen tragbaren Mikroskopes.

### Anwendung

- Qualitäts- und Industriesektor Kontrolle
- Kundendienst
- Technische Telekonferenz
- Forschung und Wissenschaft

### Notwendige Ausstattung

- Windows Vista, XP, 2000, Mac
- CD-Rom Leser
- Intel Pentium 4 1.5 GHz oder schneller (Dualcore)
- RAM :mindestens 256MB
- HD :mindestens 150MB Freiraum
- VGA Karte :16-bit oder mehr
- USB :2.0 empfohlen (Kabellänge 180 cm).

## Digital Microscope

Studied and designed for a professional use, this digital very compact microscope allows the users all high standard shootings (pictures and videos) even in real time. Zoom feature up to 200 x.

Measurements: lines, angles, diameters and radius as well, calibration.

### Practical Uses

- Quality control in industrial field
- After-Sales Services
- Technical teleconferences
- Research and science

### System Requirements

- Windows Vista, XP, 2000, Mac
- CD-ROM drive
- Intel Pentium 4 1.5 GHz or faster (Dualcore)
- RAM: at least 256 MB
- Disk: at least 150 MB of available disk space
- VGA Card: 16-bit or above
- USB : 1 available port (USB 2.0 recommended, cable length approx. 180 cm).

## Microscópio numérico

Concebido y dibujado para un uso profesional, el microscópio numérico muy compacto efectúa todas las tomas de vistas fotos y vídeos en tiempo real. Con aumento hasta 200 x.

### Aplicación

- Control calidad y sector industrial
- Servicio post venta
- Teleconferencias técnicas
- Laboratorios y ciencias

### Informática

- Windows Vista, XP, 2000, Mac
- Lector CD-ROM
- Intel el Pentium 4 1.5GHz o más rápido (Dualcore)
- RAM: a lo mínimo 256 MB
- DD: a lo mínimo 150MB de espacio libre
- Tarjeta VGA: 16 - bit o más
- Interfaz USB: 2.0 recomendado (largura cablea ~180 cm).

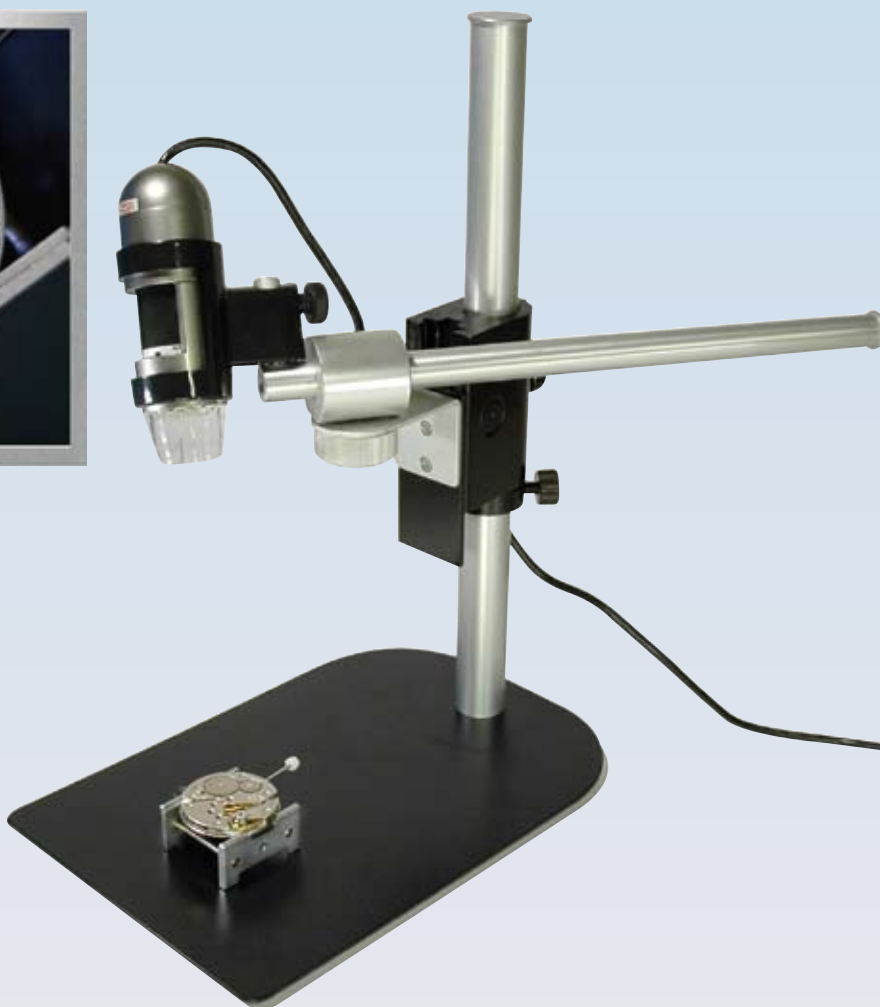





## Microscope avec support

### Données techniques

- Résolution: 1.3M pixels (1280 x 1024)
- Grossissement réglable: 10 x ~50x optique, 200x numérique
- 8 lampes LED (système déclenchable)
- jusqu'à 30 images/sec.
- Touche de déclenchement rapide
- Logiciel: Dinocapture
- Dimensions: 105 mm (H) x 32 mm (D).

## Mikroskop mit Halter

### Technische Daten

- Resolution: 1.3M Pixels (1280 x 1024)
- Verstellbare Vergrößerung: 10 x bis 50 x optisch, 200 x numerisch
- 8 LED Lampen (auslösbares System)
- Bis zu 30 Bildern/Sek.
- Schnellauslösetaste
- Logiciel: Dinocapture
- Abmessungen: 105 mm (H) x 32 mm (D).

## Microscope with stand

### Feature & Technical Specifications

- Resolution: 1.3 M pixels (1280 x 1024)
- Adjustable magnifications: 10 x ~50x, 200x
- Built-in 8 whit-light LED illumination (software switchable)
- Video frame rate: up to 30fps
- MicroTouch snapshot
- Software: DinoCapture
- Dimensions: 105 mm (H) x 32 mm (D).

## Microscopio con soporte

### Datos técnicos

- Resolución: 1.3 M píxeles (1280 x 1024)
- Aumento ajustable: 10 x ~50x óptico, 200x numérico
- 8 lámparas LED (sistema de disparo)
- Hasta 30 imágenes/sec.
- tecla de disparo rápido
- Programa: Dinocapture
- Dimensiones: 105 mm. (H) x 32 mm. (D).

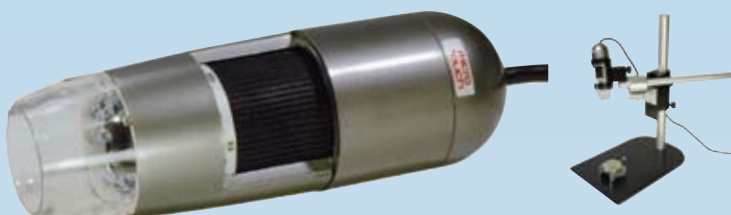

No 7003-1    1095 gr.    Pce Fr.

## 10 > 50x, 200x num.

- Avec filtre polarisé pour l'atténuation des reflets.
- Mit Polarisierungsfilter für die Abschwächung der Spiegelungen.
- With polarizer for the reduction of the reflection.
- Con filtro polarizado para la atenuación de los reflejos.



No 7003-PA-1    1095 gr.    Pce Fr.

## 500x.

- Pour l'inspection des surfaces.
- Für Oberflächen Kontrolle.
- For surfaces inspection.
- Para la inspección de las superficies.

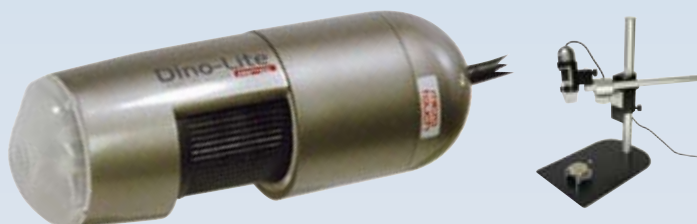

No 7004    1095 gr.    Pce Fr.

## 20 > 90x.

- Utilisé pour la formation, vision microscopique à distance.
- Benutzt für die Bildung, mikroskopische Distanzvorstellung.
- Used for the formation, microscopic vision with large working distance.
- Utilizado para la formación, la visión microscópica a gran distancia de trabajo.

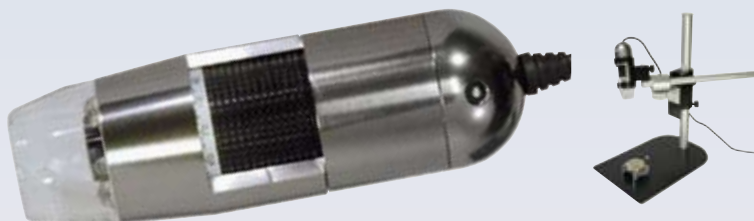

No 7006    1095 gr.    Pce Fr.

**Microscope portable  
avec écran LCD****Données techniques**

- Résolution: 0.3M pixels (640 x 480)
- Grossissement réglable: 10 x ~50x optique, 200x numérique
- jusqu'à 30 images/sec.
- 8 lampes LED
- Interface TV
- Enregistrements des vidéos et des photos sur carte SD (non fournie).

**Tragbares Mikroskop  
mit LCD-Bildschirm****Technische Daten**

- Resolution: 0.3M Pixels (640 x 480)
- Verstellbare Vergrößerung: 10 x bis 50 x optisch, 200 x numerisch
- Bis zu 30 Bildern/Sek.
- 8 LED Lampen
- Schnittstelle TV
- Erfassungen des Videos und die Fotos auf SD-Karte (nicht mit geliefert).

**Portable microscope  
with screen LCD****Feature & Technical Specifications**

- Resolution: 0.3 M pixels (640 x 480)
- Adjustable magnifications: 10 x ~50x, 200x
- Video frame rate: up to 30fps
- Built-in 8 whit-light LED illumination
- Interface TV
- Recording videos and pictures on SD-card (not included).

**Microscopio portable  
con pantalla LCD****Datos técnicos**

- Resolución: 0.3 M píxeles (640 x 480)
- Aumento ajustable: 10 x ~50x óptico, 200x numérico
- Hasta 30 imágenes/sec.
- 8 lámparas LED
- Interfaz TV
- Grabación de videos y fotos en tarjeta SD (no incluida).

No 7081

280 gr.

Pce Fr.

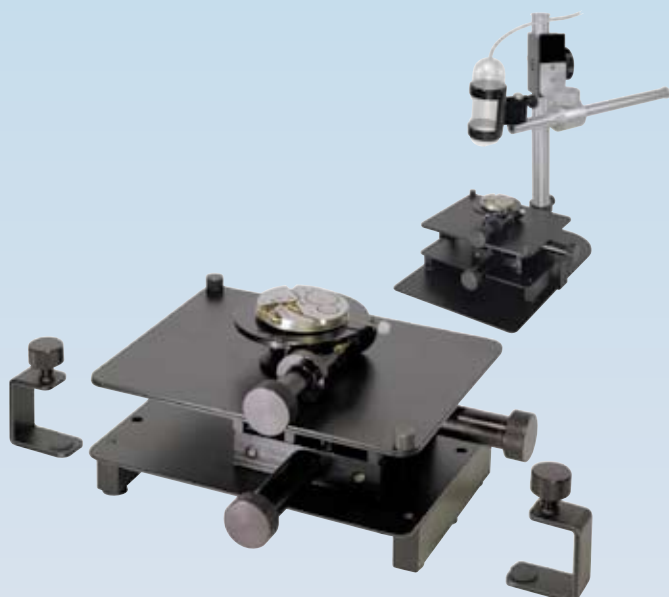
**Table en croix**

Maniable et très stable. Se fixe au statif par serrage, permet un positionnement précis des objets à observer.

**Tisch in Kreuz**

Handlich und sehr stabil. Befestigt sich am Stativ durch Festklemmen, erlaubt eine präzise Positionierung der zu beobachtenden Gegenstände.

**Cross table**

Handy and very stable. Settles on the tool-post by tightening. Allows a precise settlement of the objects to be observed.

**Nesa en cruz**

Manejable y muy estable. Se fija el torreta por presión. Permite un posicionamiento preciso de los objetos a observar.

No 7003-T

500 gr.

Pce Fr.

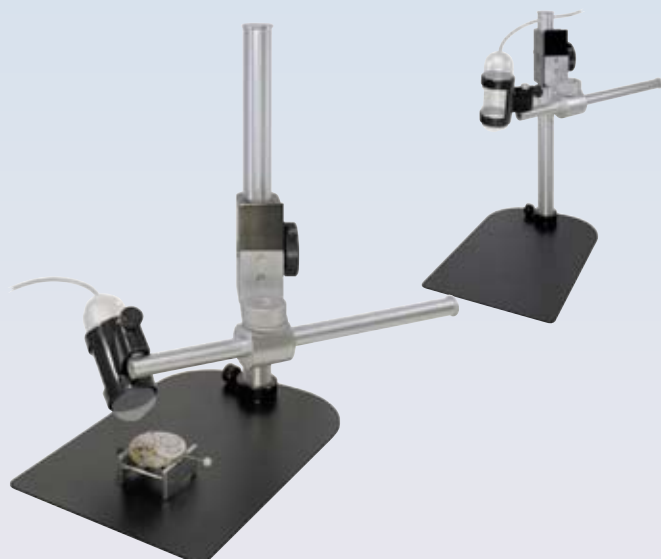
**Support seul**

Maniable et très stable. Socle métal, colonne en aluminium, éléments de réglage en acier inox. Hauteur de la zone d'observation: env. 300 mm. Réglages fins et précis. Dimensions: L 150 x P 220 x H 300 mm.

**Nur Halter**

Handlich und sehr stabil. Fussplatte in Metallstruktur, Zentralachse aus Aluminium, an welcher die verstellbare Vorrichtung aus Edelstahl angebracht ist. Sehr geräumiger Arbeitsbereich. Präzise Feinregulierung. Masse: L 150 x T 220 x H 300 mm.

**Stand only**

Handy and very stable. Metallic base aluminium vertical axis on which the inox adjustable part is fixed. Working area allowing to visualize any pieces. Thin and precise adjustments. Dimensions: L 150 x P 220 x H 300 mm.

**Soporte solo**

Manejable y muy estable. Zócalo en metal, columnal en aluminio, elemento de arreglo en acero inoxidable. Altua de la observation: ~ 300 mm. Arreglos finos y precisos. Dimensiones: L 150 x P 220 x H 300 mm.

No 7003-B2

1000 gr.

Pce Fr.



**B**  
**BERGEON**  
*Integrator*



est la réponse à vos questions et vous décharge de tous les soucis.  
*is the answer to your requiries and release you of all toubles.*



est à votre disposition et prend en compte vos besoins.  
*is at your disposition and takes your needs into consideration.*



vous offre une solution clés en mains.  
*offers you a turn-Key solution.*