



News²⁰¹⁵

新产品²⁰¹⁵



Consumables / Various
耗材/各种



B
BERGEON
Depuis 1791



Ø 60 mm

N° 7982-60-20

N° 7982-60-100

 20 x

 100 x

N° 7982-85-20

N° 7982-85-100

Ø 85 mm



Universal protection washers

To protect the components while take off / setting hands or bezels and opening/closing of screwed or pressured case backs. Resistant and flexible.

万能保护垫

无论在装或起针 / 面圈、以加压方式或以旋转方式打开及关上底盖的时候，钟表的配件都受到保护。强劲及具有弹性。

N° 7003-WIFI

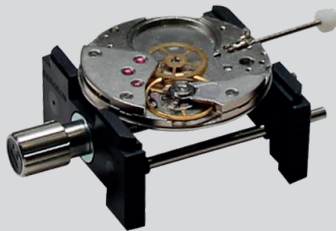

Hiview Plus
App Store



USB



Wi-Fi

Digital Wifi microscope

Photo and video resolution:
1.3 MPx - 1280 x 1024, 640 x 480, 320 x 240.
Adjustable magnification: 5x ~200x.
Rate: up to 30 fps.
Light source: 8 adjustable white LEDs.

数码显微镜连WIFI

拍摄及摄录解像度：
1.3 MPx - 1280 x 1024, 640x 480, 320x240
调节放大倍数：5x ~200x
速度：最高可达30 fps
光源：8段调节白光发光二极管

N° 7007-21

Ø 2.30 mm

20 x

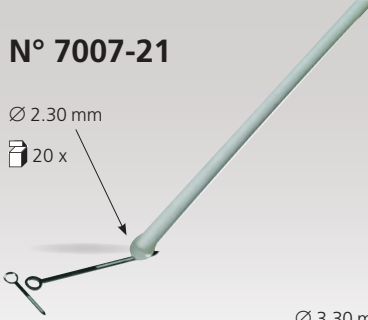

N° 7007-22

Ø 3.30 mm

10 x



Ø 2.30 mm

75 x

N° 7007-23

Adhesive swabs for cleaning and handling of components

Head of polyurethane at the extremity.
 Washable and re-usable. Total length: 74 mm.

自粘性 拿取 及清洁棒

压缩纸制手柄，聚氨酯清洁头。
 可清洗及重用。
 全长：74 mm。

N° 7007-C

**STICK
 CLEANER**

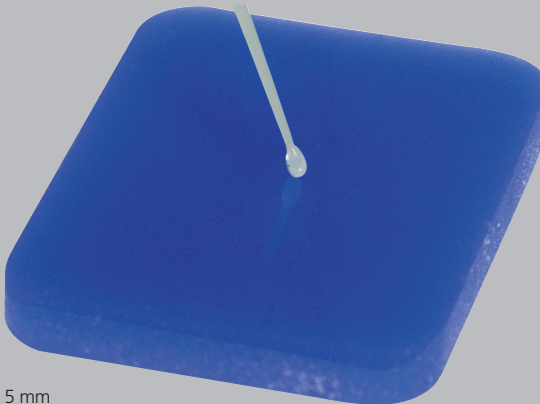

45 x 45 x 5 mm

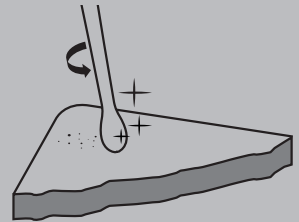

Stick cleaner for adhesive swabs

To collect the impurities on the self-adhesive swabs 7007-21/22/23. Water washable.

专为胶黏清洁棒而设的除尘清洁胶

收集不乾胶签(包括7007-21/22/23)上的杂质。可用水清洗。

N° 7966-...



Ø 15 - 18 - 21 mm



1440 x



N° 7968-...



Ø 15 - 18 - 21 - 24 mm

Latex thimbles

Antistatic, without powder. 100% biodegradable.
 Cleanroom class 1000.

天然乳胶手指套

防静电，无粉剂。
 100% 可生物分解的物料。适用于无尘室/洁净室。标准级别1000

N° 7872



Thimbles dispenser acrylic glass

亚加力盒指套盛载器

N° 6751-02

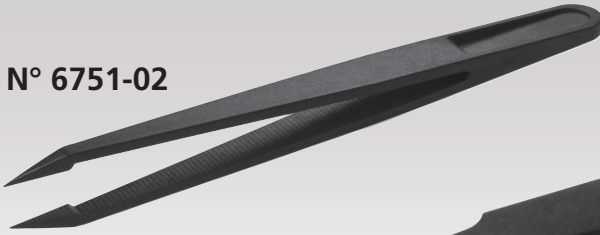

 20 x

N° 6751-03

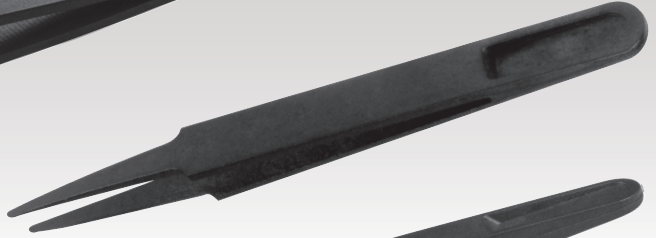

N° 6751-05



ESD carbon fiber tweezers

Usable in 10-1000 cleanroom class.

防静电碳纤维镊子

可用于无尘室/洁净室。标准级别1000

N° 5445-35

Ø 35 mm



N° 5445-60

Ø 60 mm



N° 5445-80

Ø 80 mm



Benzine cups

Cover with knob, perfectly ground lapped.
Height 30 mm.

玻璃电油盅

精细磨砂盅边以防止挥发。盅顶付有把手方便开合。
高度：30 mm。

N° 8736

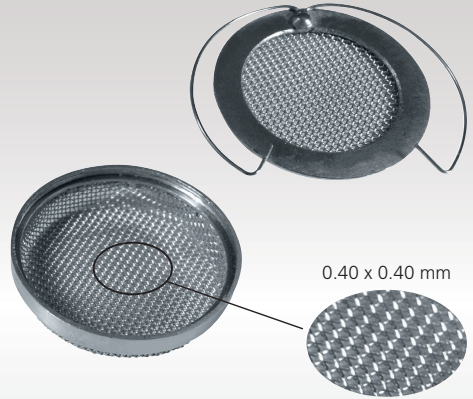

Small cleaning basket

Stainless steel. With locking spring.
 Outer Diameter: 27 mm. Height: 7 mm.

小型清洁篮子

不锈钢网，配弹锁扣。
 外径27毫米；高7毫米



N° 7241-114-W

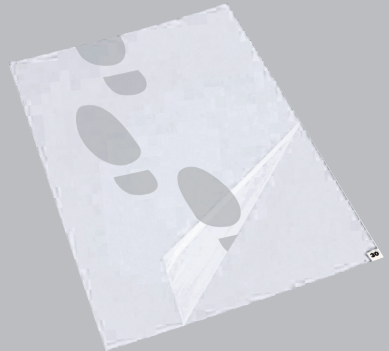
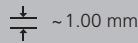
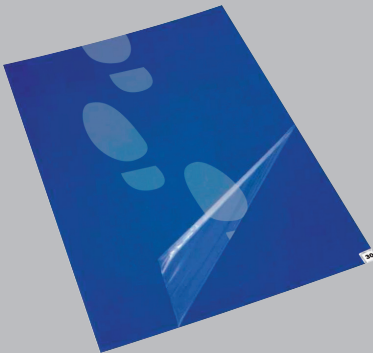

N° 7241-114-B

1140 x 660 mm

Peel-off Carpets

Self-adhesive base prevents slipping.

剥离式地毯

自动黏贴及防滑。

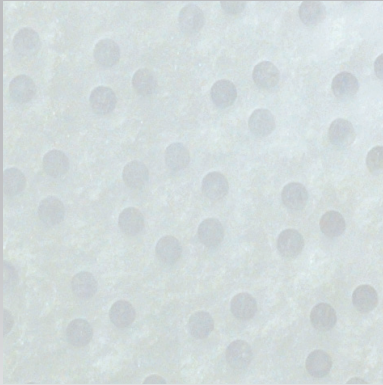

N° 7040

230 x 280 mm

 50 x



Polypropylene Wipers

For cleaning of greasy pieces and surfaces, soaked with 70% isopropyl and 30% of deionised water.

Properties: Strong grease-removing capacity. Clean tissue for ISO3 category. Does not reject fibres. Disposable.

聚丙烯抹布

渍有70%异丙基及30%脱离子水溶液。适用于清除油脂性表面或物料。

特性：特强除油性能
第ISO 3 除油抹布类别。
不脱纤维。可弃置。



N° 7039

230 x 230 mm

 100 x



100% Microfiber Wipers

Especially recommended for the wiping of gold items or components which are highly sensitive to scratches as well as anti-reflecting watch glasses.

Properties: Washable at 40°C. Non-contaminating. Does not reject fibres.

100%微纤维抹布

建议用于擦拭黄金制品或易于刮伤表面与附反射涂层的玻璃。

特性：可利用40°C以下清水清洗。无污染。
不脱纤维。

N° 7064-050-T...

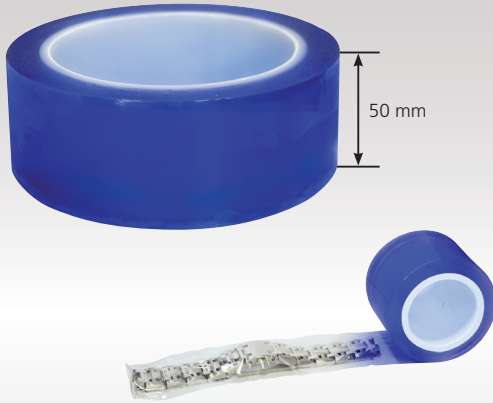

Protective Film

In antistatic transparent PVC.

Rolls of 50 m, width: 0.07 and 0.1 mm.

For packaging of watches, jewels or other items.

N° 7064-080-T...

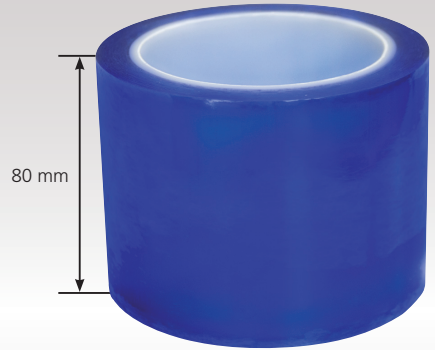

PVC 保护膜

防静电透明PVC物料。

50米卷装，厚度：0.07 或0.1厘米。

供包装手表、珠宝或其他物料。

N° 6939-S-0100-...



- Ø 20
- 30
- 40
- 50
- 60
- 80 mm.

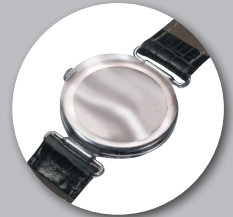

Masking sticker

In transparent PVC. **Self-adhesive** for case back.

Static for watch's glasses.

Supplied per rolls of 100 pieces.

錶面保護膜

透明PVC，**自動黏貼**於表壳底，**靜電黏貼**於表玻璃面。

每卷100張



Find all our products online
在线查找我司产品

www.bergeon.ch



OUR DISTRIBUTORS IN HONG KONG 我司在及香港的分销商

JC UNIVERSAL CO., LTD

伊博国际有限公司 香港，九龙，荔枝角，长顺街19号，
杨耀松(第六)工业大厦，10字楼，A1室。

电话：852-2664 9999 - 传真：852-2512 6491 - 电邮：info@jcucl.com.hk

NAM HING WATCH MATERIAL & TOOLS CO., LTD

南兴钟表材料行有限公司 香港，九龙，油麻地，白加士街，117号，地下。

电话：852-2388 6341 - 传真：852-2771 7972 - 电邮：nhywatch@netvigator.com

PERFECT TRADE ASIA LTD

宝思贸易有限公司 香港，新界，葵涌，大连排道，35~41号，
金基工业大厦，13字楼，G室。

电话：852-2487 6338 - 传真：852-2487 9688 - 电邮：adm@ptald.com.hk

Tools and equipment for watchmakers, jewellers, precision engineering

BERGEON SA

11, av. du Technicum
CH - 2400 Le Locle

Tél. + 41 32 933 60 00
Fax + 41 32 933 60 01

www.bergeon.ch
info@bergeon.ch